



Building Houses with

EARTH

BLOCKS



A guide for upgrading traditional building methods using handmade earth blocks



Mike Bolton with Steve Burroughs



Acknowledgements

.....

This book is based on research work undertaken for two projects:

- A development centre, built in the village of Lekgophung in the North West Province, which was funded in part by the British High Commission, with CSIR Building and Construction Technology research staff.
- A housing support centre, built in the town of Waterloo, KwaZulu-Natal, which was funded by the Australian Agency for International Development (AusAID).

The authors would like to thank all those who made these projects possible and who contributed their time and effort to make them a success.

In particular, Mike Bolton, for the Lekgophung project, would like to thank:

- Piet Potgieter, British High Commission
- Chief Tsjepe, the Tribal Authority, members of the Lekgophung Development Forum and the community of Lekgophung, North West Province
- Paul Cohen of Tlholego Trust, together with Chris Herselman and Fanki Mokokolo, who provided invaluable support on the site
- Boitumelo Hlongwa, co-ordinator of the Central District Council

Steve Burroughs has thirty five years of work experience in earth wall construction and recycling of building products and specialises in appropriate technologies.

Mike Bolton is a research architect with the Programme for Sustainable Human Settlements of CSIR Building and Construction Technology.

- members of the Boutek project team, especially Sadi Matlaba.

Steve Burroughs would like to thank the following people and organisations for their help with the Waterloo project:

- in memory of Matha, Senior Mud Brick Trainer
- Stefan Kohler - AMV Project Managers, Durban
- David Urquhart - AusAID First Secretary, Pretoria
- Lindiwe Nxumalo - Manager, Waterloo Housing Support Centre
- members of the Waterloo community who were involved with the project
- members of the Forum for Earth Building Technologies.

The authors would also like to thank Don Macleod (consultant to Agrément South Africa) and Rob Forbes (CSIR Building and Construction Technology) for their technical input and other assistance in preparing this book.

Many thanks also to the people of Australia for supporting the earth building initiative in South Africa and, in particular, for funding the production of this book.

Photographs: Ters van Wyk, Chris Herselman and Mike Bolton

Drawings: Mike Bolton

Published by CSIR
Building and Construction Technology
Pretoria, South Africa

© CSIR, 2001

ISBN 0-7988-5689-0

BOU/E0103

Production by:



A division of
Clacherty & Associates
Tel: +27-11-482-4083

Editor: Rachel Adatia

Design and layout: Nonhlanhla Vilakazi

Building Houses with

EARTH BLOCKS

**A guide for upgrading traditional building
methods using handmade earth blocks**

Mike Bolton with Steve Burroughs

CSIR Building and Construction Technology

CSIR's Programme for Sustainable Human Settlements supports national, provincial and local government, as well as communities, with the development of **sustainable human settlements** with a focus on the **built environment** - through the provision of **appropriate information** and **guidance**, as well as **relevant capacity building** initiatives based on **research** and **practical involvement** in the following areas:

- Planning, design and management of the physical environment in order to reduce crime and create safer communities.
- Developing local safety plans and facilitating community involvement in this process.
- Appropriate processes for the development and management of social housing in inner city areas.
- Eco-friendly building technologies, including earth building.
- Appropriate water and sanitation technologies, including ecological sanitation.
- Healthy housing and settlements.
- Participatory processes and skills transfer necessary for sustainable community development.
- Monitoring and evaluation of housing projects and programmes, sanitation projects, etc.
- Solid waste management and construction waste recycling.
- The role of women in housing and development.
- Sustainable development in the built environment.

The programme has the ability to work closely with community groups and to build their capacity through participatory workshops and other processes, while it can also support local, provincial and central government with capacity building programmes.

For more information contact: CSIR Building and Construction Technology,
Tel: (012) 841-3871 Fax: (012) 841-4680 Website: www.csir.co.za.

AusAID

The Australian Agency for International Development (AusAID) is the Government of Australia's official mechanism for delivering overseas development assistance. Much of Australia's aid is designed, assessed and delivered in partnership with the governments and people of partner countries. The Australian Government has five programmes in South Africa:

- The capacity building programme - focuses on building the capacity of government.
- Bilateral projects - one of the projects funded through this programme was the Waterloo Housing Support Centre project based in North Durban.
- Australia-Mandela Development Scholarships - offers 20 scholarships a year for Masters degrees in Australia.
- The Small Activities Scheme - provides grants for local community projects.
- The Africa Governance Fund - funds activities implemented by institutions of civil society, as well as government agencies.

For more information about AusAID contact: The Australian High Commission, 292 Orient Street, Arcadia, Pretoria 0083 Tel: (012) 342-7273 Fax: (012) 342-4201.

e-mail: infoausaid@ausaid.gov.au

Website: www.ausaid.gov.au

Contents



Earth: A Traditional Building Material	v
The Background to this Guide	vi
Working with this Guide	viii
Upgrading Traditional Building Methods	x
Part 1	
Soil for Earth Blocks	3
Making Earth Blocks	11
Part 2	
The Site	18
House Design	21
Foundations	24
Foundation Walls	26
Floors	28
Damp-proofing	30
Walls	34
Ring-beams	36
Windows and Doors	38
Roof	40
Wall Finishes	42
Ceiling	44
Maintenance	45
Part 3	
Guidelines for the Structural Design of Houses	48
Structural Design Criteria	50
Glossary	52

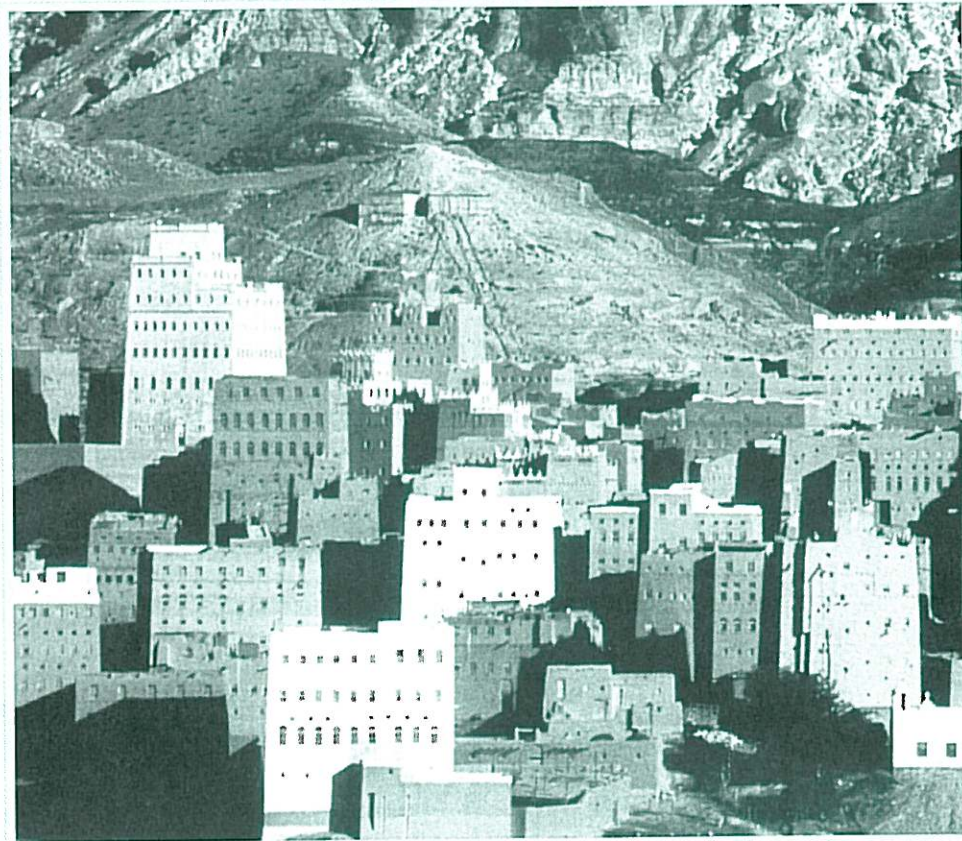

The city of Habban in Yemen. The eight-storey houses are built with earth (photographer K.H. Bochow). (From Earth Construction: A comprehensive guide, by Hugo Houben and Hubert Guillaud, IT Publications Ltd, London, 1994, reproduced with permission.)

Earth: A Traditional Building Material

Earth has been used to build houses for thousands of years. In many parts of the world traditional ways of building with earth have been adapted to include modern building techniques. Strong, long-lasting buildings can be built using earth and some countries include earth building in their formal building codes of practice, standards and regulations. In South Africa, earth buildings are not covered by the building regulations. However, this may change as the interest in earth building grows, and more people are trained to build good quality earth buildings.

Some of the benefits of using earth as a building material are:

- earth building uses local skills and knowledge of traditional building methods;
- houses with thick earth walls are 'energy efficient' and stay cool in summer and warm in winter;
- earth blocks are usually cheaper than other walling materials such as concrete blocks or bricks; and
- using local soil saves the cost of transporting bulky conventional building materials to remote rural areas.

Despite these benefits, earth houses have the reputation of being weak and needing a lot of maintenance. The main problem with using earth blocks for building is that they may not be as strong or durable as conventional building materials such as concrete blocks. Unstabilised earth blocks deteriorate if they get wet and if they are not repaired they will eventually collapse. However, this problem can be solved by using stabilised earth blocks where necessary and by building the house in a way that protects the blocks from rain or water seeping up from the ground.

This book is a guide to building strong earth houses that will last a long time but without having to spend a lot of extra money or hire outside 'experts' to do the building. It supports the process of improving the quality of earth housing and showing the benefits of using earth as a building material.

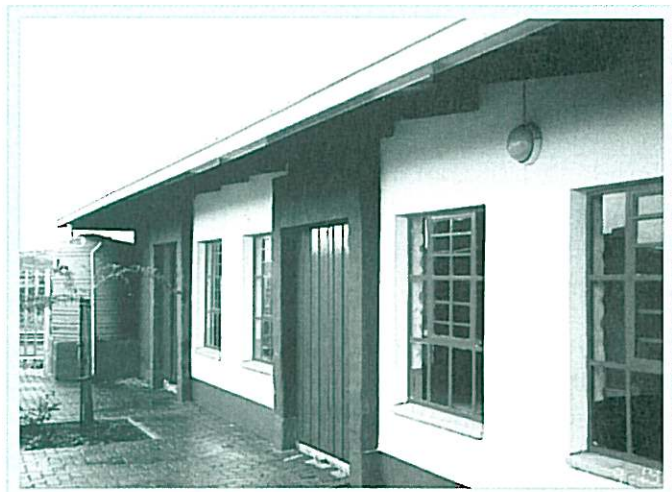

The housing support centre at Waterloo, KwaZulu-Natal, built with stabilised earth blocks

The Background to this Guide

This guide grew out of two research projects - one in a rural area and one in an urban area. Both projects were related to people's housing needs and were carried out during 1998 and 1999.

Project 1: Earth building in Lekgophung

The first project was carried out in a remote rural area where most communities provided their own housing using traditional earth building methods. The project looked at various issues, including:

- the communities' eligibility for, and access to, the government's housing subsidy;
- attitudes to traditionally built houses;
- housing costs and affordability;
- sustainable development; and
- co-operative housing.

In rural areas conventional building is expensive, mainly because of the high cost of transporting materials. Although traditionally built houses are cheaper, they need more maintenance and may not last as long as conventionally built houses. So, people prefer to spend their money or housing subsidy on more conventional methods of building.

The research team worked with 12 communities from four different district councils in the North West Province. They found that people wanted houses that were strong and would last a long time. People would prefer to build conventional houses unless it could be shown that by upgrading the traditional building method the houses would last a lot longer. In that case they would prefer to use the upgraded traditional method because then they could afford to build bigger houses for the same amount of money.

Most houses in the area were built in the traditional way using sun-dried earth blocks. The research team, together with local builders, looked at the problems of traditionally-built houses and suggested some solutions. Many of these solutions involved making some



small changes to the way the houses were built. In other words, the traditional building method was 'upgraded' (improved) to make the houses stronger.

In the village of Lekgophung, the community decided to test these suggestions by building a development centre using the upgraded traditional building methods. The local builders built the centre with advice from the research team. Earth blocks were made using soil from a pit just outside the village and other local materials were used wherever possible.

Project 2: Earth building in Waterloo

The second project looked at earth building in an urban area. The project was undertaken with members of the community in Waterloo, KwaZulu-Natal, who preferred the 'people's housing process' for the delivery of their housing, using the housing subsidy to fund them.

At the beginning of the project two demonstration houses were built using earth blocks that were stabilised with bitumen emulsion. The community liked what they saw and chose to build their own houses with the stabilised blocks. A housing support centre was then built using the same technologies. The centre provides materials and training for people interested in the earth building methods used in the project.

This book is based on the knowledge and experience gained from the projects at Lekgophung and Waterloo.

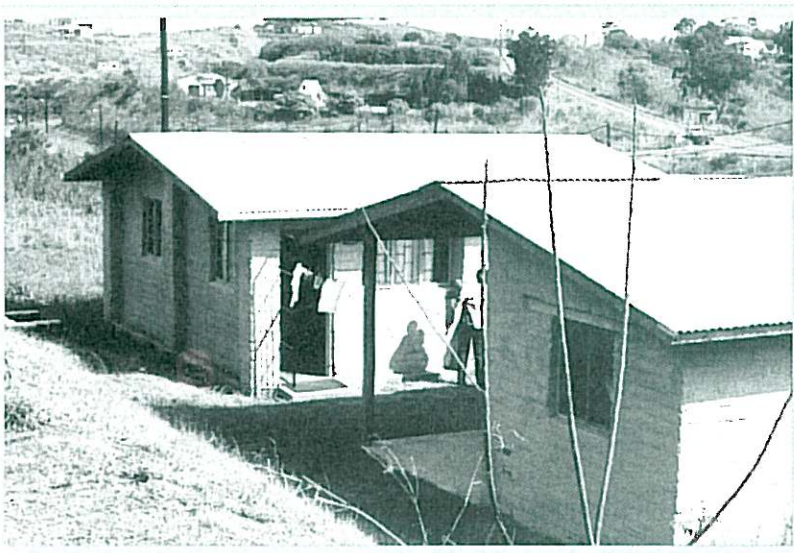

Working with this Guide

This book describes, step-by-step, how to test soils, make earth blocks and build strong, durable houses based on a traditional 'mud' block building method. It is written for people who understand the basic building processes. It can be used by family members working together to build their own house or local builders working on many houses. Use the book as a guide to building an earth block house and to help you:

- find the cause of some common problems with earth buildings; and
- solve some of those problems without a big increase in costs.

Part 1 of the book shows how to make strong earth blocks.

Part 2 is divided into sections that relate to the different parts of a building, or stages in the building process. Each section lists some common problems found on the building site and suggests some solutions. **Part 3** explains the structural design criteria for the building methods shown in the book. It includes a glossary which explains some of the technical words that are used.

Building methods

The building methods shown in the book are based on the traditional sun-dried earth block building methods that are used in many rural areas of South Africa. However, to make the houses stronger and more durable some changes have been made using practices taken from conventional house building. These changes have been kept to a minimum, to keep the cost of building as low as possible.

Design criteria

The building methods described in the book are appropriate for a simple, single-storey, small to medium-sized house or other similar building, which can stand up to certain wind speeds and other conditions. See the structural design guidelines (page 48) and criteria (page 50). A structural engineer must assist with the design of any building that does not follow the structural design criteria given in this book.

Building regulations

Building regulations help to make sure that buildings meet certain standards, so they won't fall down, catch fire or cause other health and safety problems for the owners. All conventionally built houses in urban areas should conform to the National Building Regulations set by the South African Bureau of Standards (SABS 0400). In rural areas there are no regulations for houses built using traditional methods. Although the guidelines in this book may not comply with all the National Building Regulations, they will help you build strong, longer lasting houses using traditional building methods.

Looking at cross-section drawings

Most of the drawings that are used in this guide are cross-section drawings which show the inside of the house walls, as if the house had been cut with a knife. The drawing below shows a house with parts of it cut away so we can see inside the walls, roof, floor and foundations.

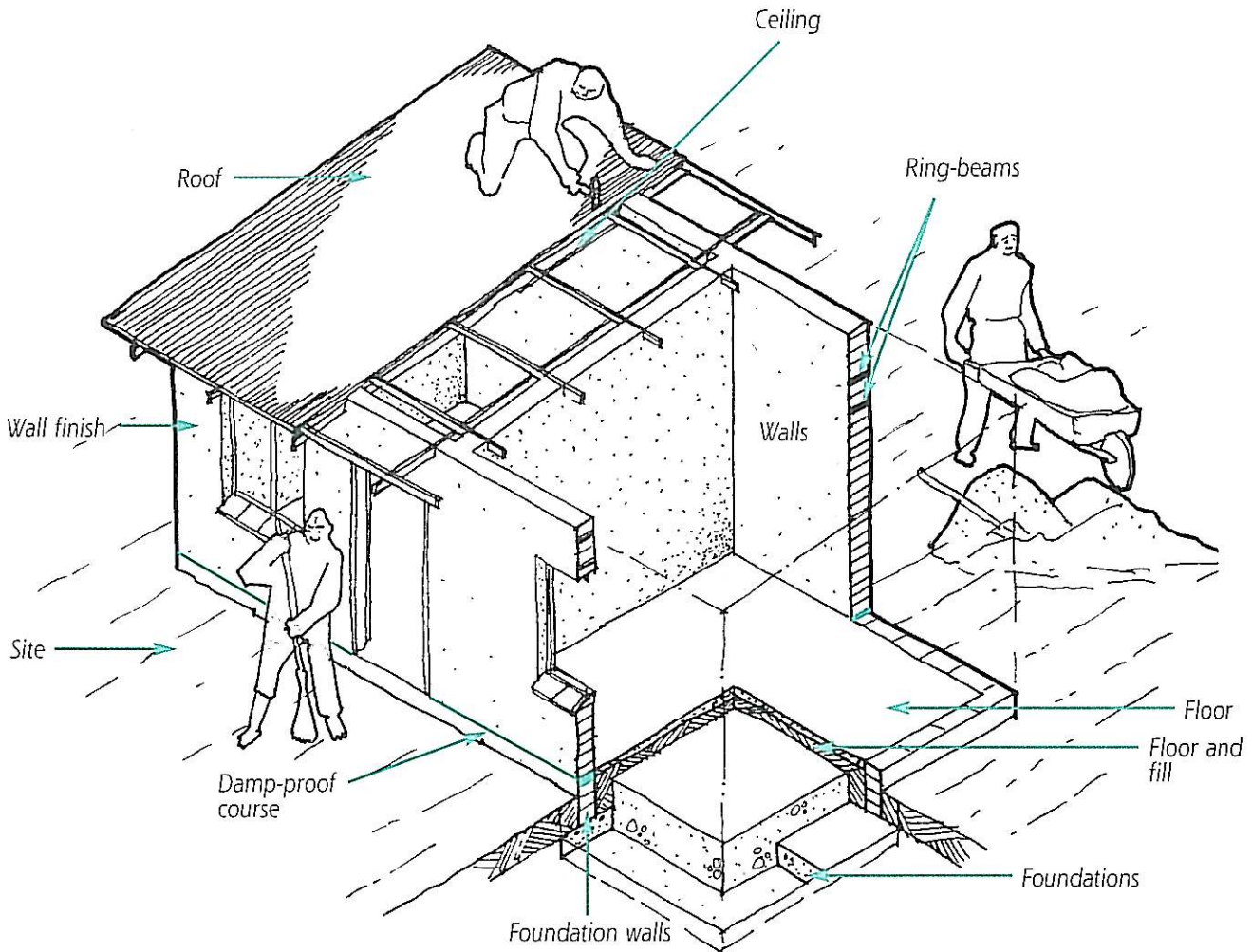

Looking at a cross-section drawing is like looking at the cut side of a slice of bread - it shows what the loaf of bread looks like inside.

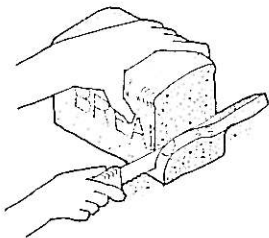

The drawings in this book use different patterns to show the ground, stabilised and unstabilised earth blocks. These patterns are shown on the drawing below.

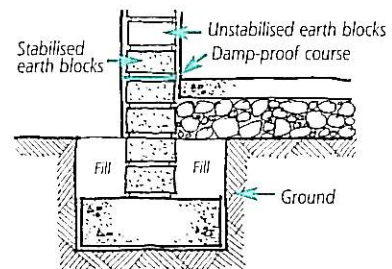

Upgrading Traditional Building Methods

The cross-section drawing below shows some of the common problems found in traditionally built houses. Use this guide to help you prevent these problems by building the house with the features shown in the drawing on the opposite page.

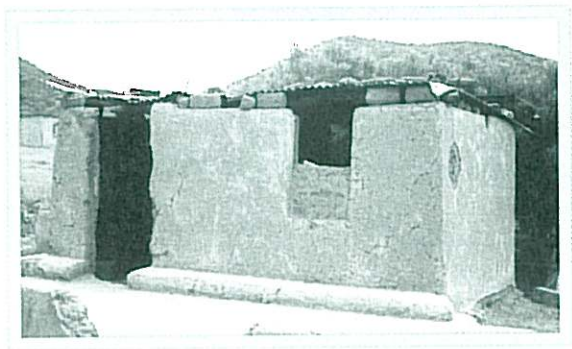
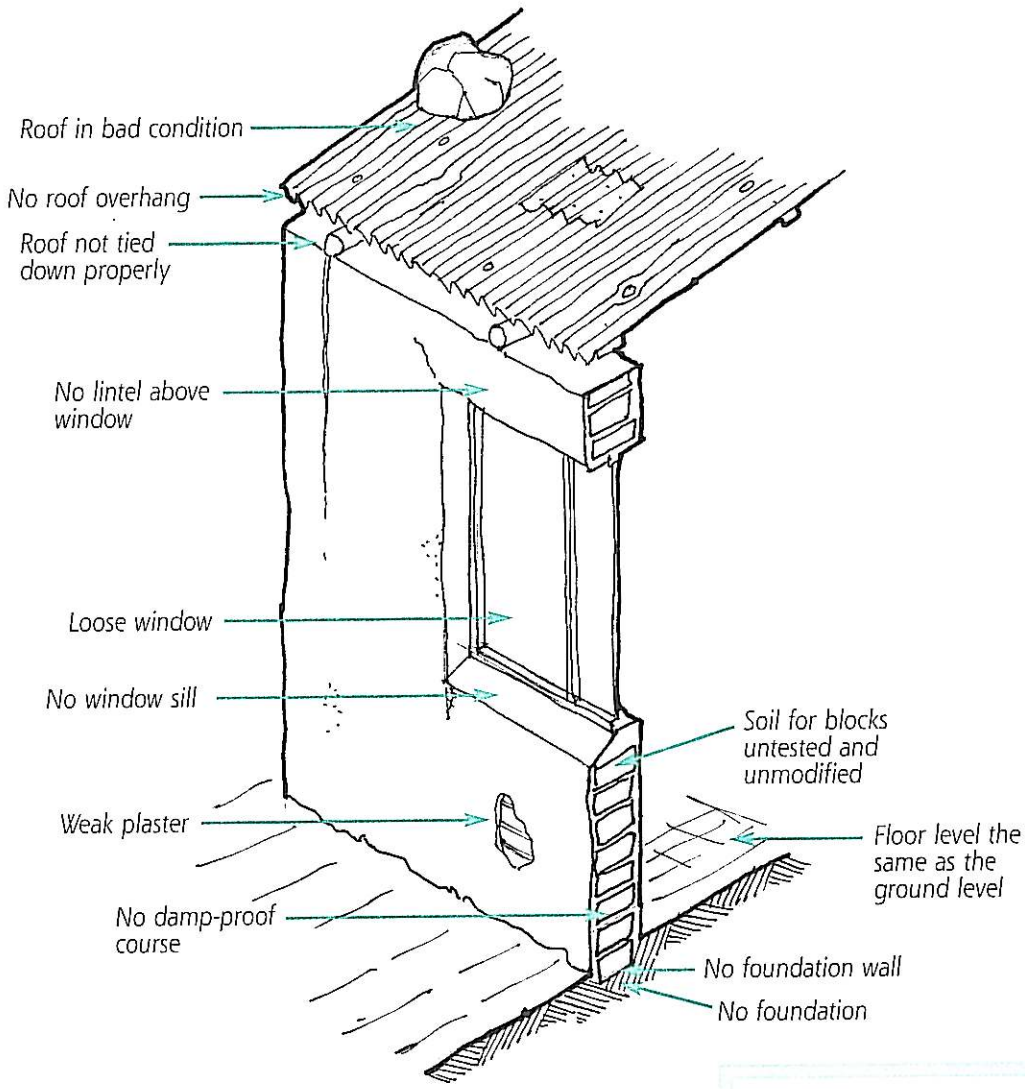

How many problems can you find with this building?

This cross-section drawing shows some of the solutions to the building problems shown in the drawing on the previous page.

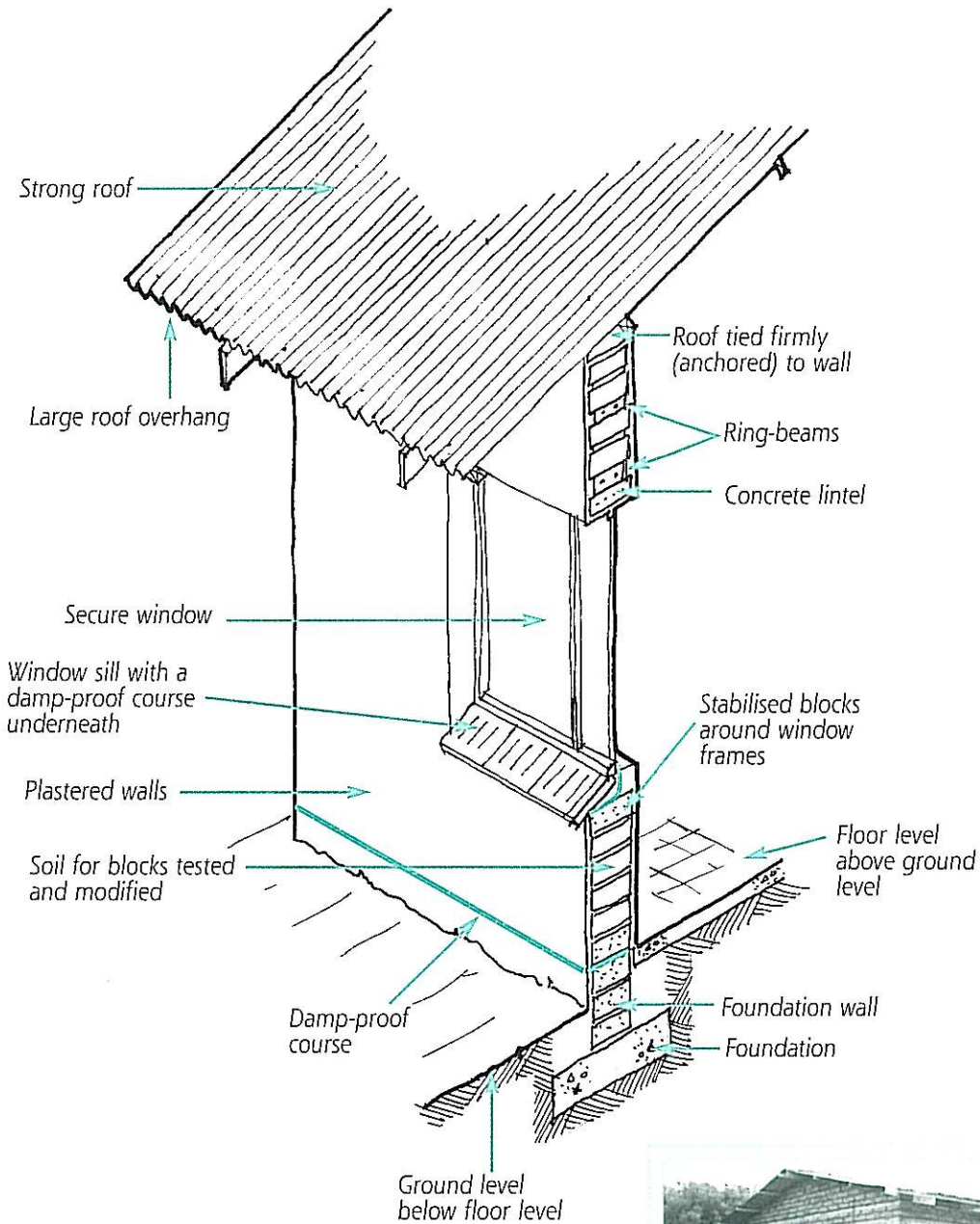

How is this building different from others in your area?

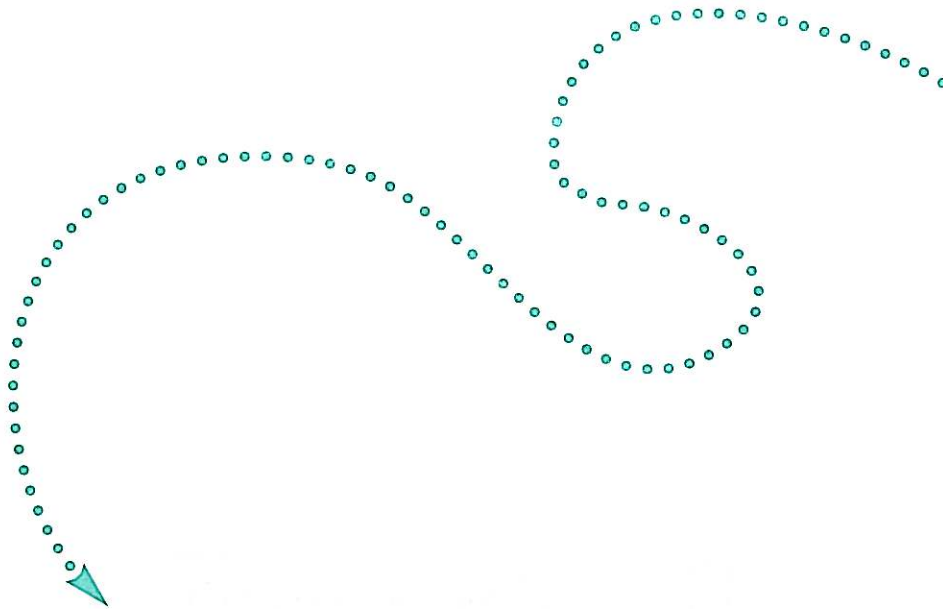

To make strong earth blocks you need to know your soil: What proportions of sand, silt, clay or gravel does it contain? Do you need to add any binder to help make the blocks strong? How the blocks are made is also important: How big should they be? How long should they be left to dry? How can you test the blocks to make sure that they will be good for building? This section will help you to answer questions like these.

If you do a lot of building with earth you will gain experience of different types of soils and mixes. Keeping a record of the soil and block tests, and their results can help you become an expert in making good earth blocks.

Soil for Earth Blocks

One of the main reasons for using soil as a building material is that it is usually freely available close to the building site. Most rural villages will have communal pits from which soil for blockmaking is taken. There are many different types of soil, but they are not all good for making blocks. **Never use topsoil** for blockmaking. Soils can vary within a very short distance of each other, so it is important to check for changes.

Earth blocks have to be strong enough to support the weight of the walls, stand up to weather conditions and the normal wear and tear expected on the walls. The strength of the blocks depends on the soil mixture they are made from.

The soil must be tested to see if it is suitable for blockmaking. You can do this by using the simple tests described in this section. If many houses are to be built, the testing of soils in a laboratory would give more accurate results, but it is expensive and the laboratory could be a long way from where the blocks are to be made.





The soil tests will show the most suitable binder (see page 4) to use and give some idea of what proportions should be used. However, it is important to make a number of sample or test blocks, using different proportions of binder with the soil so you can see the quality of the blocks and decide which mixture is best for you.

Suitable soils are usually found below the layer of topsoil at a depth starting from about 200 mm. The soil must be free of stones, plant material like grass and roots, and any rubbish like plastic and tins. These can be easily removed by sieving the soil using a mesh of between 6 to 10 mm.

Size of soil particles

Soil is made up of many particles or grains. There are four main groups of soil particles: gravel (the largest particles), sand, silt, and clay (the smallest particles). Soils for making blocks must have some gravel, sand, silt and clay, but in the appropriate proportions (see page 10).

The four different groups of soil particles:

Gravel		Sand		Silt		Clay	
2 mm - 20 mm		0.06 mm - 2 mm		0.002 mm - 0.06 mm		0 mm - 0.002 mm	



Binders

To make a strong earth block, the particles must be held or glued together. This glue is called a **binder**. A binder is added to soil to **stabilise** it. Clay is a natural binder and soils that have the right amount of clay can make good blocks, but they are not stabilised blocks because the binding properties of clay are not permanent - when the clay gets wet it will not hold the particles together.

Binders that can be used to make **stabilised** earth blocks include:

- cement
- lime
- bitumen emulsion.

You can add clay or sand to the soil to change its characteristics (properties) to suit the type of binder you have available. Binders are expensive and should not be wasted, so follow the guidelines given on page 9 for the amount of binder to use.

As a rule of thumb, use cement or bitumen emulsion as a binder for sandy soils, and lime for soils that contain more clay. Adding lime or bitumen emulsion stabilises the soil and lets in less water.

For parts of the house where the blocks have to be extra strong and durable, only use cement as a binder. This applies particularly to the foundation walls of a house which are often damp - depending on the season and the groundwater conditions.

For a strong stabilised block, each grain of soil should be coated with the binder. This means that more binder is needed for soils that have smaller grains (finer soils) than for soils with larger grains (coarser soils).

Soils must be tested to see how much binder, if any, needs to be added to produce a good quality block. Use the tests described in the next section to find out about the properties of your soil and the amount and type of binder it may need. Then make a few blocks and test them (see *Making Earth Blocks*, page 11). If the tests show the blocks are strong you can use the same soil mixture to make stabilised blocks for the whole house or for parts of the walls that need extra strength. If the blocks fail the tests, you will need to change the soil or binder in the mixture. Testing the blocks will help you get a feel for the soil and quality of the blocks and can help to avoid problems later on.

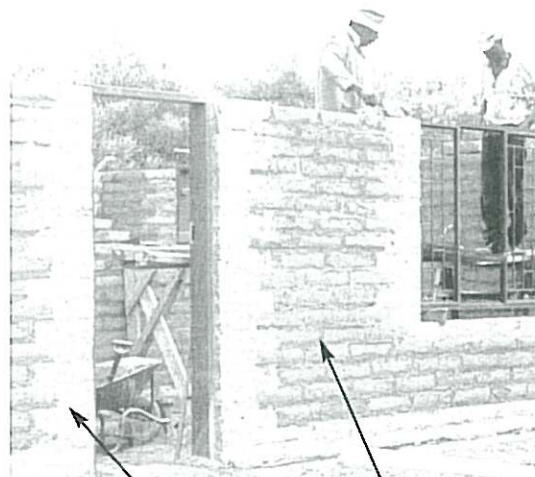

Stabilised blocks used for extra strength around window and door frames

Unstabilised blocks

Unstabilised earth blocks need more clay than stabilised blocks. The clay helps to hold the soil particles together. But you must make sure that unstabilised blocks are dried properly before building with them.

Clay can hold a lot of water. It shrinks as it dries out and swells (expands) when it gets wet. If the blocks are not dried out well, shrinkage cracks will appear in the walls.

If unstabilised block walls get damp they can swell, deteriorate, and cause the wall to collapse. This is why it is important to protect unstabilised earth walls from the rain and from water moving into the walls from the ground.

Cement is a common binder, and is available from hardware or builders' shops. It is normally sold in 50 kg bags. Where possible, buy ordinary Portland cement marked with (CEM II) or (CEM IIA) on the packets. Cements that are already mixed with fly ash (PFA) will not be as good with soils that have a lot of clay in them, but they will work with more sandy soils if they are cured well.

Lime (hydrated) is used to stabilise soils for road building and it can also be used for making stabilised blocks. It is usually more expensive than cement and may only be available from some hardware shops, agricultural co-operatives or road building companies working in the area. It is sold in 50 kg bags.

See page 9 for the proportions of binders and soil to use when making stabilised earth blocks.

Bitumen emulsion is also used to stabilise soils for road building and has been successfully used for making stabilised blocks. It is usually available in 200 litre drums, but for smaller projects, ask the supplier to provide about 25 litres at a time, to make it easier to transport and to store. It should not be stored for longer than one month or be exposed to temperatures below freezing as it tends to separate and becomes unusable. The type of bitumen emulsion to get is CSS-1h, which stands for:

C = cationic

SS = slow setting

1 = 1 hour setting time

h = hard bitumen.

The next section describes three tests you can use to find out if your soil is suitable for making good earth blocks:

Test 1: Soil composition - to see how much gravel, sand, silt and clay is in the soil;

Test 2: Soil plasticity - to see how much active clay is in the soil (active clay shrinks when it dries and swells when it gets wet);

Test 3: Shrinkage - to see how much sand and clay is in the soil and how much binder is needed to stabilise the soil.

All the tests are easy to do on site and you do not need any special testing equipment. Write down the results of the tests in a notebook and keep notes of any sample mixes you make. These notes are useful to check the proportions when you prepare mixes of larger amounts of soil for the block-making.

If you are working on a large project that involves many houses, it may be worth getting your soil tested at a soil laboratory. If possible, use soil from the same place to make all the blocks for the house. If soil is used from different places then the soil from each place will have to be tested.

Soil testing

Test 1: Soil composition by sedimentation

For this test you will need:

- a one or two litre cold drink bottle
- a tape measure or ruler
- a marker pen

Step 1

Put some dry soil in a bottle. Compact the soil by gently tapping the bottom of the bottle on the ground. Add more soil and compact it until one third of the bottle contains soil. Measure the distance from the bottom of the bottle to the top of the soil. Write the measurement down.

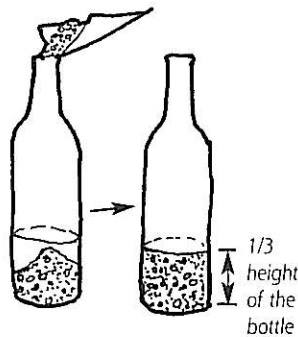

Step 2

Fill the bottle with clean water and add a teaspoon of salt (the salt will help the soil particles to separate).

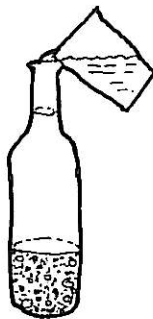

Put your hand over the top of the bottle and shake the bottle. Then put the bottle down.

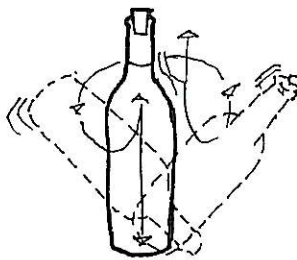

Step 3

After one hour shake the bottle again and then put it down and let the soil settle.

Step 4

After about 45 minutes, the soil particles will have separated out. The sand and gravel will form a layer at the bottom of the bottle with a layer of silt above it. The clay will still be in suspension in the water. Mark the levels you can see.

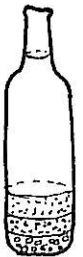

Step 5

After 24 hours the clay should have fallen out of the water to form a layer on top of the silt. Mark the level of the clay. Check the depth of each layer again. Measure the distance from the bottom of the bottle to the top of the top layer and use this distance (total) to work out the proportions of clay, silt, sand and gravel (see page 10).

Compare the composition of your soil (the proportions of gravel, sand, silt and clay) with those recommended on page 10.

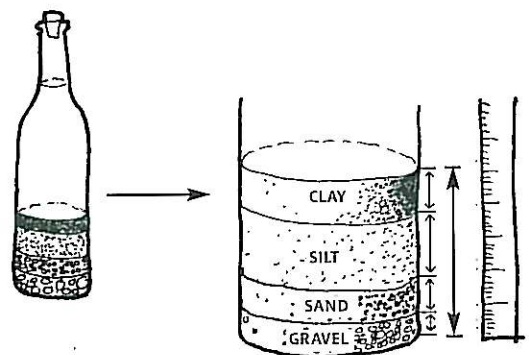

Step 6

Keep a record of the soil composition in your notebook. If you notice any changes in the soil you use for the blocks, do this test again and compare the results. Use the information to make changes to the soil mixes as necessary.

Test 2: Roll test for plasticity

This test is used to see how much clay is in the soil. Clay helps to bind soil particles together and so helps to strengthen earth blocks, but too much clay can cause problems when the blocks dry out or get wet.

Step 1

Mix a small amount of soil, about 2 kg, with water. Add the water in small amounts until you can make a soft ball with the soil. Knead the soil and then, on a flat surface, roll it into a sausage shape with your hand - make it as long as possible and about 20 mm thick.

Step 2

Pick the soil roll up, and hold it lightly in the middle with one hand.

With your other hand, gently pull the roll out by about 10 mm and release it. Repeat this until the weight of the piece that you have pulled out causes it to break off.

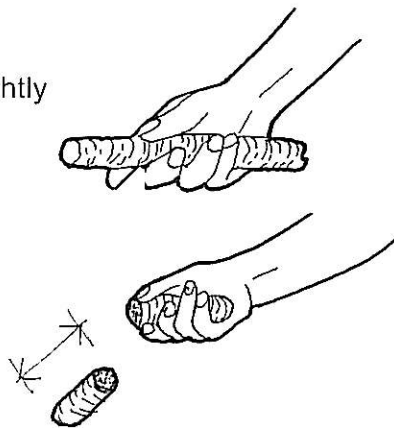

Step 3

Measure the length of the broken piece of soil roll.

- (a) If the broken piece is less than 50 mm long, it means that the soil is too sandy for unstabilised earth blocks. Clay could be added to improve the quality of the soil; or cement could be used as a binder to make stabilised earth blocks (check the amount of cement needed, see Test 3).
- (b) If the broken piece was longer than 50 mm but shorter than 150 mm, the soil is suitable for making unstabilised earth blocks. Cement can, however, still be added to make stabilised blocks.
- (c) If the broken piece is longer than 150 mm the earth contains too much clay and should not be used for making earth blocks as they would crack because of the shrinkage of the clay. Sand could be added to improve the quality of the soil.

Test 3: Shrinkage test

This test can tell you if the soil has the right amount of sand and clay in it to make strong unstabilised blocks. You can also use it to find out the lowest amount of cement that should be added to the soil to make stabilised blocks and so avoid wasting expensive cement.

Step 1

Make a box with wood so that the inside of the box is 600 mm long, 40 mm wide and 40 mm deep. The box must have a bottom but no top. Make sure that the inside surfaces of the box are smooth so that, when they are oiled, the soil will not stick to them.

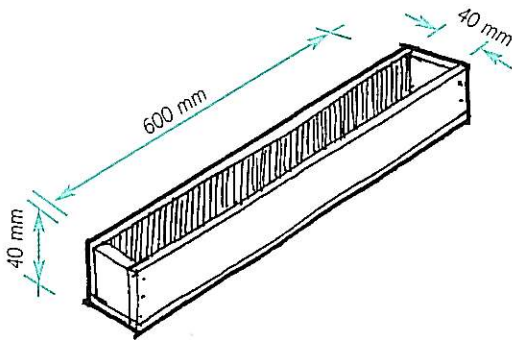

Step 2

Mix about 1 kg of soil with water so that it becomes a stiff mud. You should be able to squeeze it through your fingers.

Step 3

Place the mud into the box with a small trowel and compact it to remove any excess air. When the box is full, smooth off the top.

Step 4

Put the box in a shady, dry place and leave it so the mud can dry out. This usually takes 3-5 days. As it dries out the mud may shrink and crack.

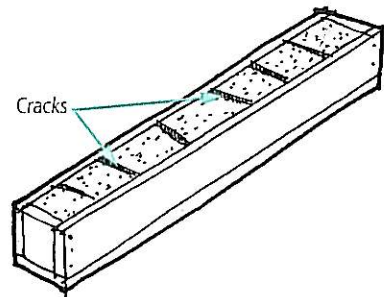

Step 5

If the mud has cracked, gently tap the box so that the pieces of mud move up to fill the cracks. There should only be one gap at the end of the box. Measure this gap - it shows how much the soil shrank.

If the gap is less than 15 mm the soil may be too sandy and need more clay. If the gap is more than 60 mm the soil has too much clay and so more sand needs to be added to it.

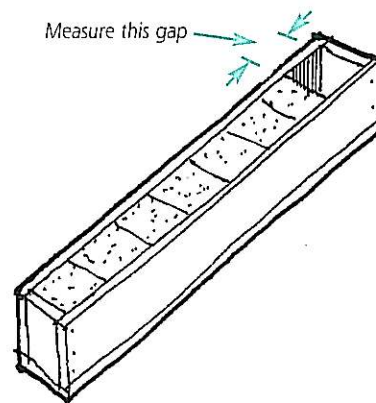

Stabilisation of earth blocks

Cement and lime

If you want to make stabilised earth blocks, using cement or lime as the binder, the shrinkage test can help you find out how much binder to use (see the box below). In general, sandy soils will shrink less than soils that have more clay and will need less cement to produce a good stabilised block. Soils with more clay can be stabilised best with lime.

Because there are so many different types of soil, the best way to decide how much cement or lime to use to stabilise a certain type of soil is to make a few blocks and test them. The next section, *Making Earth Blocks*, shows you how to do this.

The results of the shrinkage test will help to show how much cement and lime to use to make stabilised earth blocks

(see the box about proportions on page 10)

Size of gap in shrinkage test box	Proportion of cement to soil by volume	Proportion of lime to soil by volume
Less than 15 mm	Use 1 part cement to 18 parts soil	Not suitable
15 mm - 30 mm	Use 1 part cement to 16 parts soil	Not suitable
30 mm - 45 mm	Use 1 part cement to 14 parts soil	1 part lime to 14 parts soil
45 mm - 60 mm	Use 1 part cement to 10 parts soil	1 part lime to 10 parts soil

More cement can be added to soil than has been suggested here. However, this will increase the cost of making the stabilised earth blocks without necessarily increasing the quality. Too much lime can cause a decrease in the strength of the blocks. It is important to do a shrinkage test to find out the amount of lime to use.

Bitumen emulsion

Sandy or silty soils are most suited to stabilisation with bitumen emulsion. Typical proportions by volume vary from 1:50 (1 part bitumen emulsion to 50 parts soil) to 1:12.

If too much bitumen emulsion is added the blocks will be weaker. Because of soil differences, it is better to make some blocks using different mixes of soil and binder, and to choose the mix that makes the strongest block.

See page 16 for some questions that will help you decide whether or not to make stabilised earth blocks. The building methods you use, the type of soil and binders available and the cost will all affect your decision.

Measuring proportions

To make earth blocks you need to mix soil, water and other materials in the right amounts (proportions). To measure the amounts you can use a bucket, wheelbarrow or any other container, depending on how many blocks you want to make.

Example

if you need to mix two materials in a proportion of 1 to 10 this means you will need:

1 bucket of the one material



and

10 buckets of the other material



Proportions can also be measured in percentages. You can use the results of Test 1, the soil composition test (page 6), to work out the percentage of gravel, sand, silt or clay in your soil sample. After you have measured the layers of clay, silt, sand and gravel (Test 1: Step 5):

- divide the depth of each layer by the total depth of the soil sample; and then
- multiply this number by 100 to get the proportion of each layer as a percentage of the total.

Example

In a soil composition test the total depth of soil was 10 cm. The depth of the clay layer was 1 cm. The proportion of clay as a percentage of the total was: $\frac{1}{10} \times 100 = 10\%$

Two 50 kg bags of either cement or lime will fill one concrete wheelbarrow.

What proportions of gravel, sand, silt and clay do you need for **stabilised** earth blocks?

Gravel: Not more than 40% of the soil.
At least 25% of the soil.

Sand: Not more than 50% of the soil.
At least 25% of the soil.

Silt: Not more than 25% of the soil.
At least 10% of the soil.

Clay: Not more than 20% of the soil.
At least 5% of the soil

To make stabilised blocks, good proportions of clay, silt, sand and gravel are shown in this soil sample:

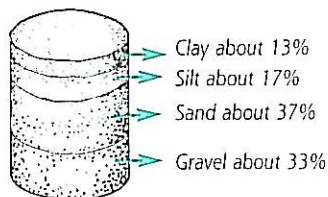

What proportions of gravel, sand, silt and clay do you need for **unstabilised** earth blocks?

Gravel/Sand: Not more than 50% of the soil.
At least 40% of the soil.

Silt/Clay: Not more than 60% of the soil.
At least 50% of the soil.

To make unstabilised blocks, good proportions of clay, silt, sand and gravel are shown in this soil sample:

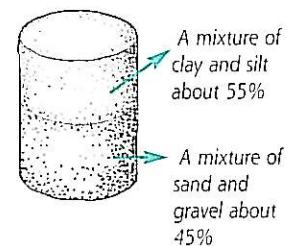

Making Earth Blocks

After you have found your supply of soil, and tested it to make sure it is suitable, the block-making work can begin. This section shows how to make earth blocks using a simple and cheap method that does not need any specialist skills. This method was used successfully to make earth blocks in the Lekgophung and Waterloo projects. A checklist for making earth blocks is given on page 16.

Block size

There are no standard sizes of blocks. To make the building easier and for good bonding, blocks should be twice as long as they are wide. Small houses are usually built with walls 200-250 mm thick. Bigger buildings may need thicker walls. Don't forget that the bigger the blocks, the heavier they are and the more tiring it is to lay them. The maximum weight of a block should be between 12 kg and 15 kg.

The block gauge is the height of the block, plus the thickness of the mortar joint. The block gauge affects the height of the lintel and the roof. Each handmade block will be slightly different from another. This means that when the blocks are laid, the thickness of the joints will vary - usually between 15 mm and 25 mm.

A good size block to make would be 200 mm wide, 400 mm long and 100 mm thick. This would give a gauge of 120 mm. The blocks would weigh between 12 kgs and 14 kgs.

Moulds

Moulds for handmade earth blocks are usually made of wood or steel. If it is difficult to make your own mould, try to buy one from your nearest hardware shop, even if the size is different from the block size suggested above.

The moulds have side and end pieces, with the top and bottom left open. Some form of handle or grip is fixed to each end so that the mould can be lifted off the block when it is cast. If the sides of the mould tilt slightly inwards at the top this makes it easier to lift the mould off the new blocks.

Moulds should be washed and oiled regularly to prevent the soil sticking to the inside surfaces and to make them last as long as possible.

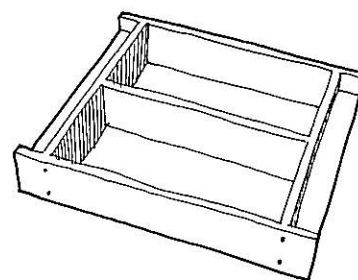
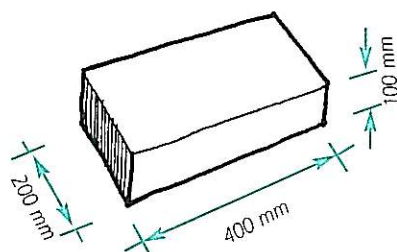

This two-block mould was made from 20 mm thick wood. It was used at Lekgophung. Four-block moulds were used in the Waterloo project.

Preparing and mixing the soil

Before the soil is put into the block moulds it needs to be prepared and mixed with water to the right consistency. A binder may also need to be added to make stabilised blocks.

Preparing the soil

Prepare the soil by:

- *sieving* through a 6 mm sieve to remove any stones and make the soil easier to work with;
- *blending* - if the tests show that it requires adding either clay or sand; and
- *leaving it to dry out* - particularly if it is to be mixed with cement or lime.

You can make a stockpile of prepared soil near the place where the earth blocks are to be made, or make the blocks at the source of the soil and then move them to the building site. A 35 m² house will need about 28 m³ of soil.

Adding a binder (if necessary)

Mixing soil with a binder, like cement or lime, is best done on a clean, flat surface, using a shovel. The soil should be dry. Bitumen emulsion needs to be mixed with water, so it is best to use a pan-mixer. If a pan-mixer is not available, mix it by hand on a clean, flat surface.

Mixing with water

The amount of water that must be used in a mix will depend on the soil type and the amount of water already in the soil. Add enough water so the soil mixture can be easily worked into the mould by hand, and so that the block will keep its shape once the mould has been lifted off the block. It is useful to mix a sample of soil first to test before mixing large quantities. Keep a record of the mix proportions you have used so you can make sure that all your batches are the same.

If you are going to make unstabilised blocks, the soil can be prepared in a shallow hole or pit in the ground. The pit should be about 1.5 m wide and 0.5 m deep. Put some soil in the pit and then add some water and let the soil soak for some time before making the blocks. This may make the soil easier to work with. Mix the soil by walking around in the mud until an even mix is achieved. If you don't want to soak the soil it can be mixed on a clean, flat surface.

Some common tools are needed to dig the soil and make blocks, these include:

- builder's wheelbarrow • pick • shovel
- spade • hosepipe • builder's bucket
- short wooden straight edge
- sieve (if necessary) • block moulds
- gumboots (if using the pit method of mixing)
- rubber gloves (builder's type)

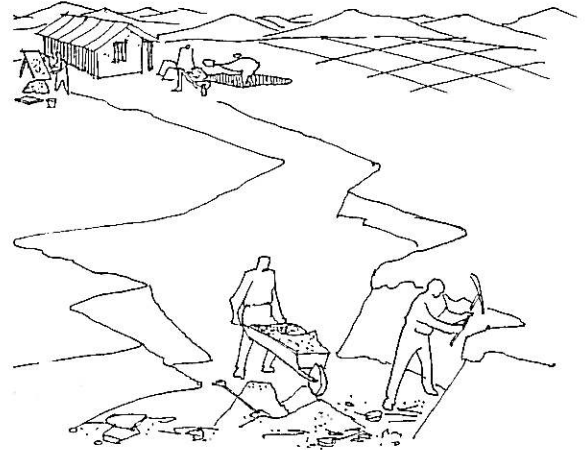

The soil can be dug out of a communal soil pit and then taken to the building site where the blocks are made



Mixing dry soil with cement to make stabilised blocks

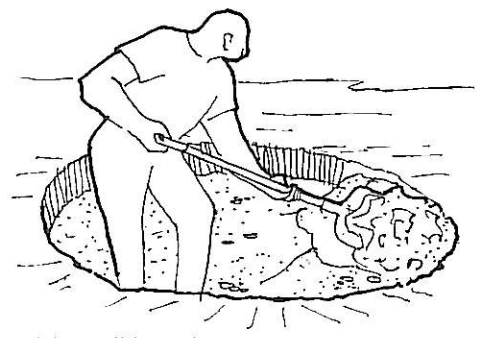

Mixing soil in a pit

Moulding the blocks

The process of moulding the blocks is the same for both stabilised and unstabilised blocks. It is important to only use clean moulds which have been lightly oiled (with diesel or old sump oil) to stop the soil mix from sticking to the sides of the mould.

Prepare a clean, flat surface to cast the blocks (to turn them out of the mould). A concrete slab is best but if this is not available then use a level piece of ground cleared of any plants and stones. Put a piece of plastic, sack-cloth (hessian) or shade cloth over the ground to stop loose soil sticking to the blocks. Cleaning off loose soil wastes time and can lead to blocks getting broken.

The process of making the blocks is described in the following steps. The mould shown here makes two blocks at once.

Step 1

Put the mould on a flat, clean surface.

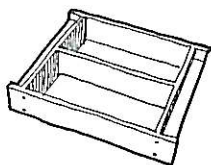

Step 2

Use a shovel to fill the mould with the prepared soil mix.

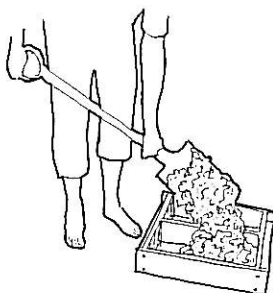

Step 3

Press the soil mix into the mould so that it fills up all the corners of the mould. Compact the soil to make sure that all the air has come out.

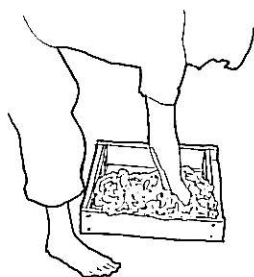

Step 4

Use something with a straight edge to scrape any extra soil mix off the top of the mould.

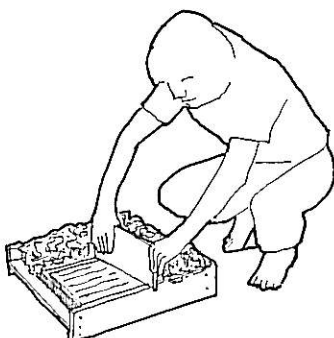

Step 5

Lift the mould off the soil mix and leave the blocks to dry.

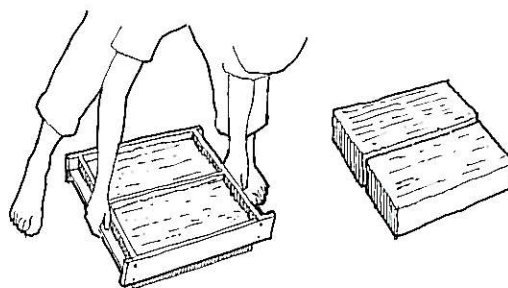

The sides of the blocks should stay straight. If the blocks start to sag, it means that there is too much water in the soil mix.

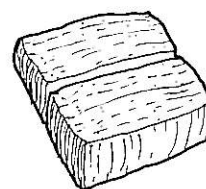

Sagging blocks mean too much water in the mix

Step 6

Clean and re-oil the mould between each casting if necessary.

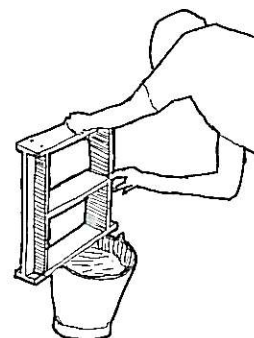

Curing and stacking

Curing helps to strengthen the blocks. It is the last thing that needs to be done to make the blocks as strong as possible. Leave the wet blocks undisturbed until they are hard enough to be moved.

Curing unstabilised blocks

1. In normal weather conditions leave the blocks for about three days in the sun. They must be covered if it rains.
2. Lift the blocks and put them down on their edges in rows. This will help them to dry out. Leave them for about three weeks.
3. The blocks can now be stacked and are ready for use. The blocks must still be protected from rain.

Curing blocks stabilised with cement or lime

1. In normal weather conditions, leave the new blocks for a few hours so that they can begin to get hard. After this cover the blocks with plastic sheeting for between four and seven days to stop them from drying out too quickly. The dampness helps the binder (cement or lime) to get as strong as possible. If you do not have any plastic sheeting, leave the blocks in the shade or cover them with corrugated iron sheeting, and put some water on them three or four times a day.
2. Stack the blocks and leave them to dry out for another two or three weeks before using them. It is important to do this as the blocks will continue to shrink, and if they are used too soon you will get shrinkage cracks in the house walls.

Curing blocks stabilised with bitumen emulsion

1. Cover the blocks with plastic sheeting and leave them for one or two days.
2. Lift the blocks and stand them on their edges for one week to dry out.
3. The blocks can now be stacked and are ready for use.



Quality control and testing

Here are a few simple checks that you can do on site to make sure that the blocks are of good quality.

Take five blocks out of the pile at random for testing.

Test 1

Look at the blocks to see if they are cracked. If the cracks are wide and as long, or longer, than one third of the width of the block - do not use them. If there is more than one crack - do not use them. If the soil has a high clay content the blocks may have small, scattered cracks. These blocks can still be used.

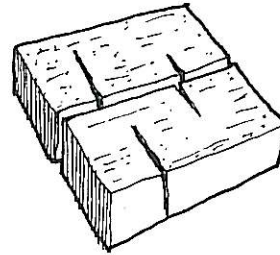

These blocks have large cracks and should not be used

Test 2

Lift a block up to knee height and drop it onto the ground. If it breaks into many small pieces the basic soil mix is wrong - do not use the blocks. If it breaks into two or three large pieces it means the blocks are strong enough to use.

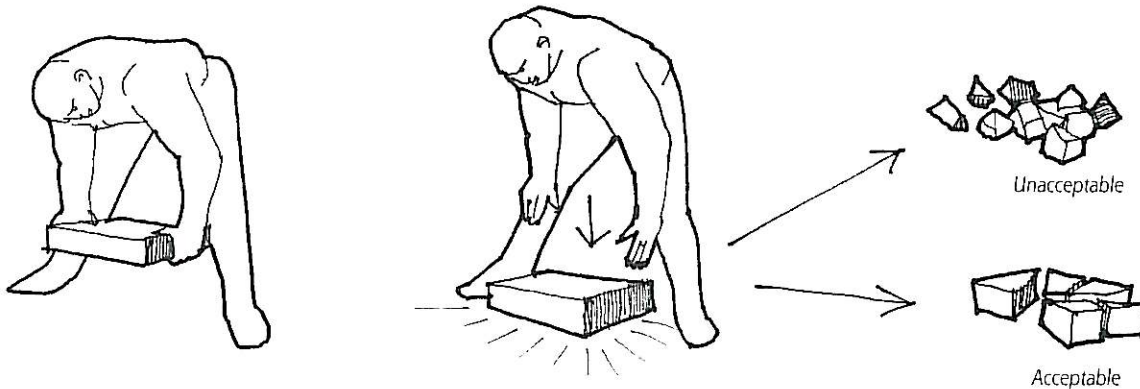

Test 3

Put two blocks on the ground with a gap of about 300 mm between them. Place another block on top of them, over the gap. Stand on the middle of the top block with one foot. If the block breaks it means that the blocks are not good enough to use. You will have to test the soil again and make some new blocks. If the block doesn't break it means the blocks are strong enough to use.

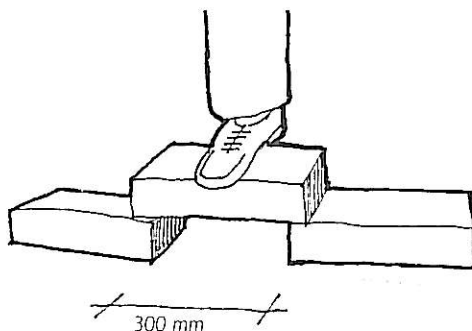

If earth blocks need to be protected from water, why not stabilise all earth blocks?

This guide shows the use of both stabilised and unstabilised blocks. For the Lekgophung Development Centre both stabilised and unstabilised blocks were used. For the Waterloo housing support centre, all the earth blocks were stabilised. Whether or not you choose to stabilise all your earth blocks depends on the answers to questions such as:

- What is the soil like?
- What kind of blocks can be made from it?
- Is it necessary to change the nature of the soil, for example by adding sand to soil that has a lot of clay?
- What kind of binder is easily available?
- How much would it cost to make stabilised blocks?
- How much would it cost to protect the walls from water? (For example, using cement plaster, building the roof with wide overhangs)
- How strong do the blocks need to be? (For example to support the weight of the wall and to resist damp)
- What can you afford?

Use the information in this guide to help you answer these questions and to decide what is best for your situation.

Check-list for making good blocks

1. Prepare soil properly by:
 - sieving (if necessary)
 - adding more sand or clay (if necessary)
 - drying
2. Mix the binder (if needed) and soil well
 - cement and lime mix better with dry soil
 - bitumen emulsion is mixed in with water
3. Use the right amount of clean water
 - this means use water that is safe to drink, dirty water makes bad blocks
4. Mix the soil, binder and water to the right consistency
 - this makes it easy to work into the mould by hand
 - the mix should not slump when the mould is removed (the block should keep its shape)
5. Keep moulds clean and well oiled
 - they last longer and make better blocks
6. Be careful how you mould the blocks
 - make sure the mix is well compacted (by hand) so that all the air is out of the mix and the corners of the mould are filled
7. Cure the blocks well before use
 - this results in stronger, better blocks with fewer cracks
8. Check quality regularly
 - do soil tests regularly so any bad mixes of soil or batches of blocks can be removed and the soil mixes adjusted

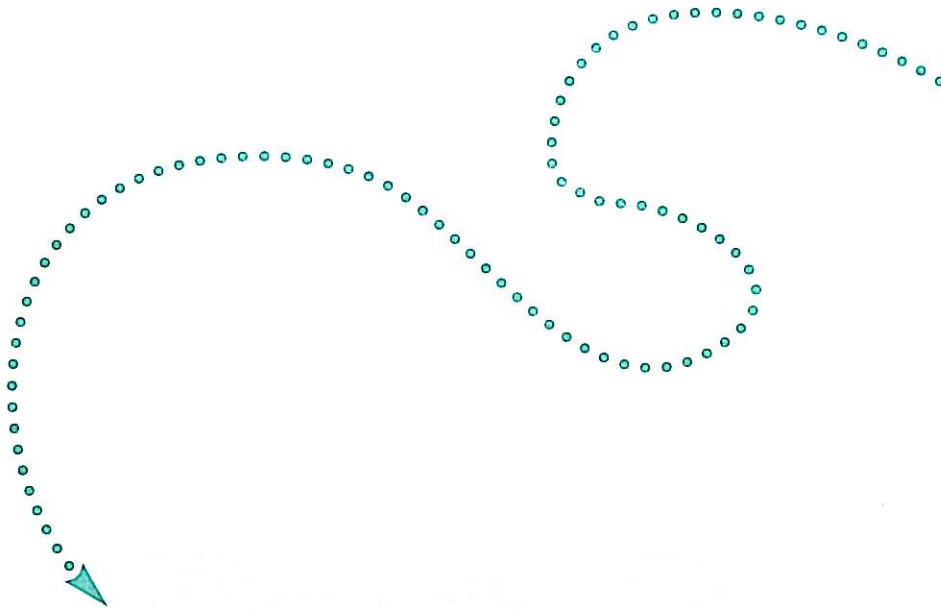

Each section in this part of the guide looks at a different stage in the house building process. Use the information to help you build a house with earth blocks that is stronger and lasts longer than traditional houses built with earth. Find out how to strengthen the walls of the house and to stop water damaging and weakening the earth blocks. Use each section, together with your own experience of houses in your area, to solve some common building problems.

The Site

The site is the piece of land on which the house is built. The ground conditions can cause problems such as cracks and damp in the walls. However, preparing the site properly and choosing suitable building methods and materials can help to avoid these problems.

It is important to check the site carefully. The questions below suggest some of the things to look out for. Use what you find out about the site to design the house and choose suitable building methods and materials.



Checking the site

- *Is the ground firm and stable?* To check this look at other houses in the area to see if they have any cracks, or ask a building inspector for advice.
- *Is there a river flowing through or near the site?* If so, does it flood regularly? Water on or near the surface of the ground is a sign that the water table is high. If it looks as if water has flowed across the site at any time - be careful!
- *Are there any plants or trees whose roots could damage the house?* Be careful of trees and bushes whose roots grow sideways and are near the surface of the ground. But keep some trees and bushes - on the west side of the house they are good for shade.
- *Are there any rocks that could be used for building the house?*
- *Could soil from the site be used to make blocks?* Is there a local, communal pit in the village from which you could get soil?
- *How big is the site?* Could part of it be used to grow crops or keep cattle or sheep? Make sure the house is positioned so that it will be easily accessible from the road. Leave room for extending the house in the future.

Common problems

- Damp in the house because it was built in an area with a high water table. Damp or wet ground can weaken earth blocks and walls.
- House walls may crack because of:
 - movements caused by certain ground conditions, such as heaving clay or dolomite;
 - foundations sinking because they were built on soft soil or fill and not on solid, firm ground;
 - roots of some trees take a lot of water out of the ground and this causes the ground to move.

Some solutions

- Look at the older houses in the area to see if they have any problems. If they have, try to find out if they are related to the ground conditions or ask a building inspector for advice.
- Don't build on unstable ground (ground which may move such as heaving clay or dolomite) - try to find another site.
- Make sure the house is built on a site that will not be flooded.
- Make sure that the ground slopes away from the house so that water does not collect around the walls.
- Prepare the site properly before starting to build.
- Don't let trees grow too close to the house.

Preparing the site for building

Before starting to build the house it is important to prepare the ground properly. This involves clearing the ground where the house is to be built and removing the topsoil from where the floor of the house will be.

On sloping ground you may have to 'cut and fill'. This means digging out some of the soil and small rocks from the slope above the house and using it to raise the floor of the house on the down-slope side. You will also have to build foundations with foundation walls that are higher on the down-slope than up-slope side. The following drawings show different ways to make the floor of the house level on different types of slopes.

On slight slopes:
Raise the whole floor above the ground.

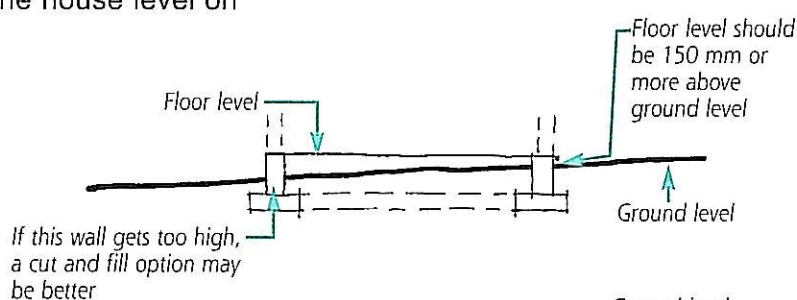

On steep slopes:
Cut and fill to make a level platform for the house. Use the soil you cut out on the uphill side of the house to fill in the lower section.

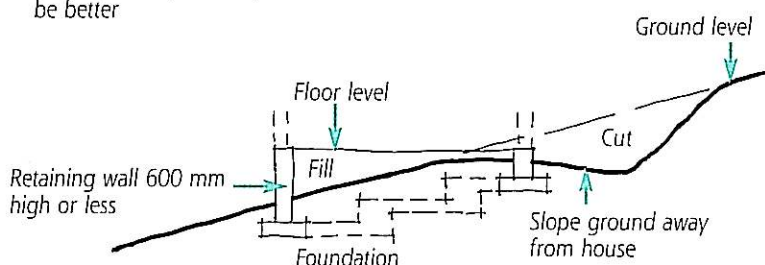

If the retaining wall needs to be higher than 600 mm, ask for advice on how to build it.

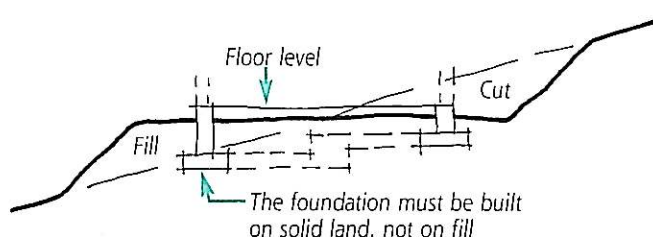

On very steep slopes:

The floor of the house can be built on more than one level. The foundation wall between the two levels has to be built carefully to prevent water from going into the house and to be strong enough to retain the fill. If the difference in level is more than 600 mm the foundation wall must be designed by an expert. (See *Foundation Walls and Damp-proofing*).

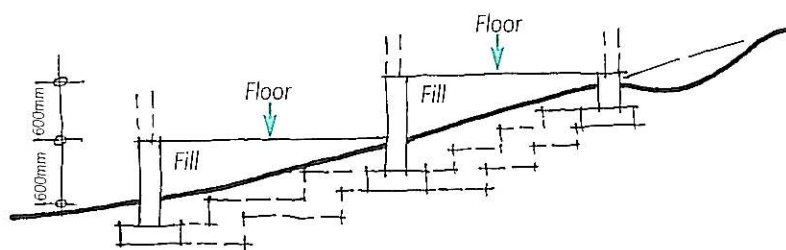

Damp

If something is damp it means that there is water in it. If a house is damp this water can cause serious problems. It can:

- weaken the structure of the building by damaging the earth blocks, wood or plaster;
- encourage mould to grow which can cause health problems for the people living in the house; and
- damage carpets, furniture or other objects that are in contact with the damp areas.

Houses can get damp from:

- rain-water splashing on to the walls or dripping down the outside walls from the roof;
- leaking roofs; and
- water in the ground moving up through the foundations, foundation walls or the floor and into the rest of the house. Water moving through the walls from the ground is called rising damp.

There are two main ways to protect a house from damp:

1. Having a good roof that acts like an umbrella – with wide roof overhangs to make sure that the rain falls off the roof away from the walls.
2. Putting a waterproof barrier in the walls and under the floor – this is called damp-proofing (see page 30).

Gutters and downpipes can also help to lead water away from the walls. Window sills help to protect the walls below the window frame from getting wet.

House Design

- What will the house look like?
- Which direction should it face?
- How many rooms will it have?
- How big will each room be?
- Where will the doors and windows go?
- How will the house be built and what materials will be used?
- Will any extra rooms need to be added to the house in the future?
- How much will it cost? Will it be affordable?

These are the types of questions that need thinking about when the house is designed. It is worth designing the house carefully as a good design can help to reduce building costs (for example by using local materials) and reduce fuel bills for the people who will live in the house.

Design to save fuel costs!

Earth blocks are good insulators. This means they are good at keeping the house warm in winter (by keeping the heat from a fire inside the house) and cool in summer (by keeping the sun's heat outside the house). Here are some other ideas for designing houses that are 'energy efficient' – which means that less fuel is needed to keep them warm in winter.

- Put a ceiling below the roof. A ceiling helps to keep the house warm in winter and cool in summer (see *Ceilings*).
- Houses with zinc or corrugated iron roofs and no ceilings get very hot during the day in summer and cold at night in winter. However, thatch roofs help to keep houses cool in summer and warm in winter.
- Position the windows to let in warmth from the sun in winter, but keep it cool in summer.
 - let heat in by putting a bigger window in north-facing walls (north-facing walls get more sun in winter);
 - don't put any windows (or only put small windows) in west-facing walls, this keeps the rooms cool (west-facing walls get the most sun in summer).

The size of the house will affect its design, how it is built and the materials that are used. The designs shown in this section are suitable for small to medium-sized houses that are built using the building methods shown in this guide (see Part 3 for the design criteria).

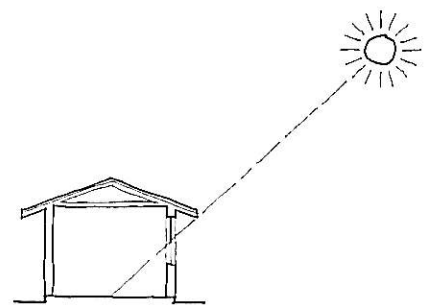

In winter north-facing wall gets more sunshine

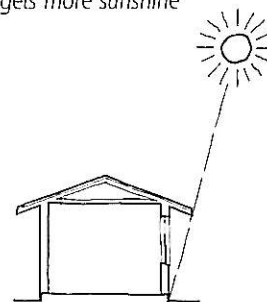

In summer north-facing wall gets less sunshine

Cross-section of a house showing the north-facing wall

Ideas for a house design

The drawings in this section show two designs for a house that can be built using the building methods shown in this guide. Elevations are drawings that show what the house will look like from the outside. The cross-sections and plans show the inside of the house.

Design 1

This is a design for a house that is first built with a roof that only slopes one way (a mono-pitch roof). Later, the roof can be extended at the back of the house and another room built. The house will then have a roof sloping in two directions (a double-pitch roof).

These designs are for a starter house. Later, when the owner has time and money, and when services become available, a kitchen, bathroom and other rooms can be added onto the house. So remember to leave enough space around the house for future additions. This process of building houses in stages is called incremental housing.

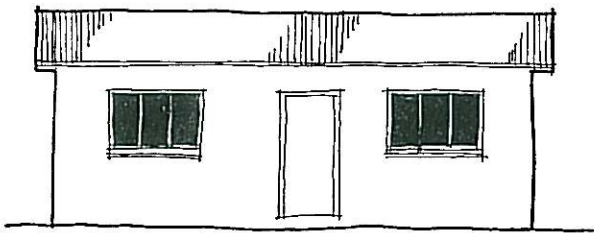

North elevation, showing the front of the house which faces north

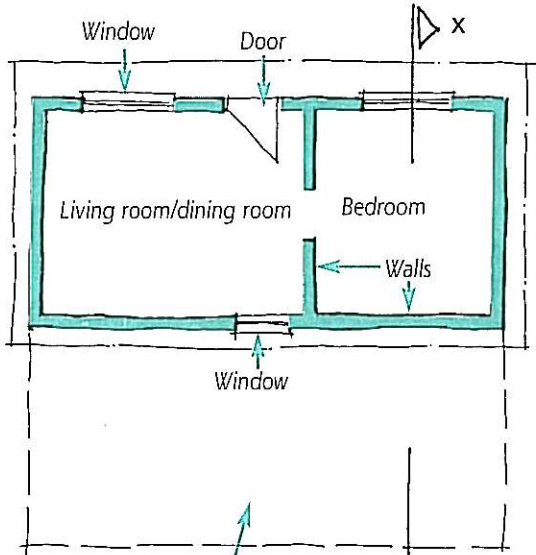

This area at the back of the house can be used to build other rooms. The back window can be made into a door for the new room

This plan shows the inside of the house as if you are looking into it through the roof

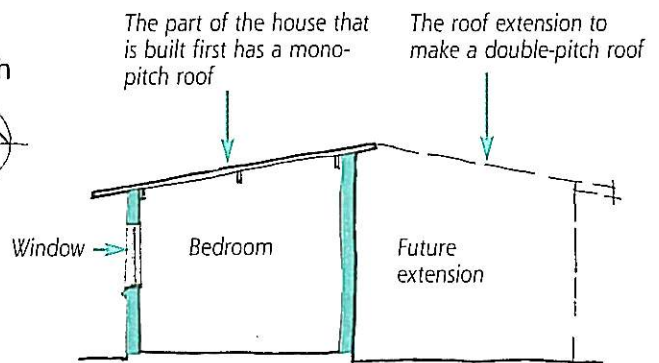
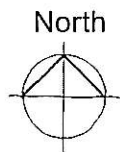

Cross-section through the bedroom, from points x to y on the plan. The dotted lines show an extra room that can be added to the back of the house

Area of house when first built (starter house): 30 m²
 Area of extension: 29 m²
 Area of house with extension: 59 m²

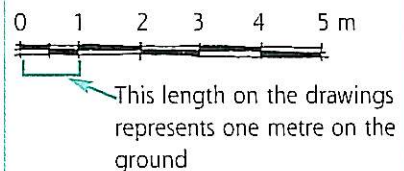

Design 2

This design is for a house that is first built with a double-pitch roof. The roof and floor can be built at the side of the house to form a covered area. Later, walls for the extra rooms in this area can be added.

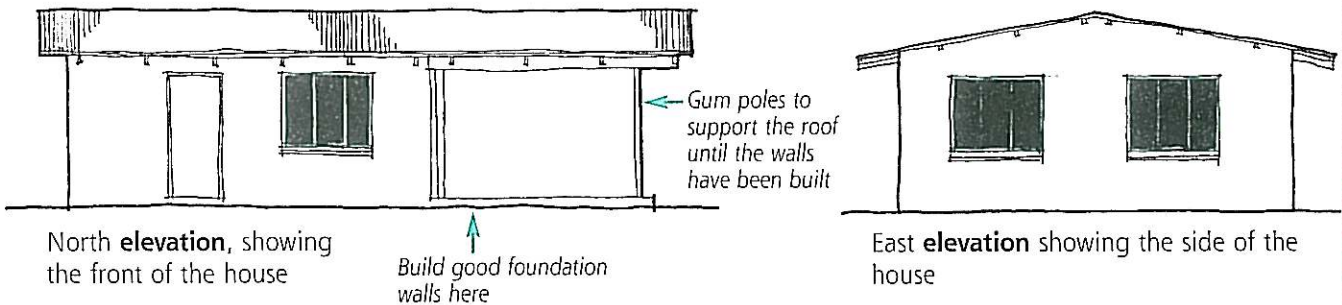

North elevation, showing the front of the house

Build good foundation walls here

East elevation showing the side of the house

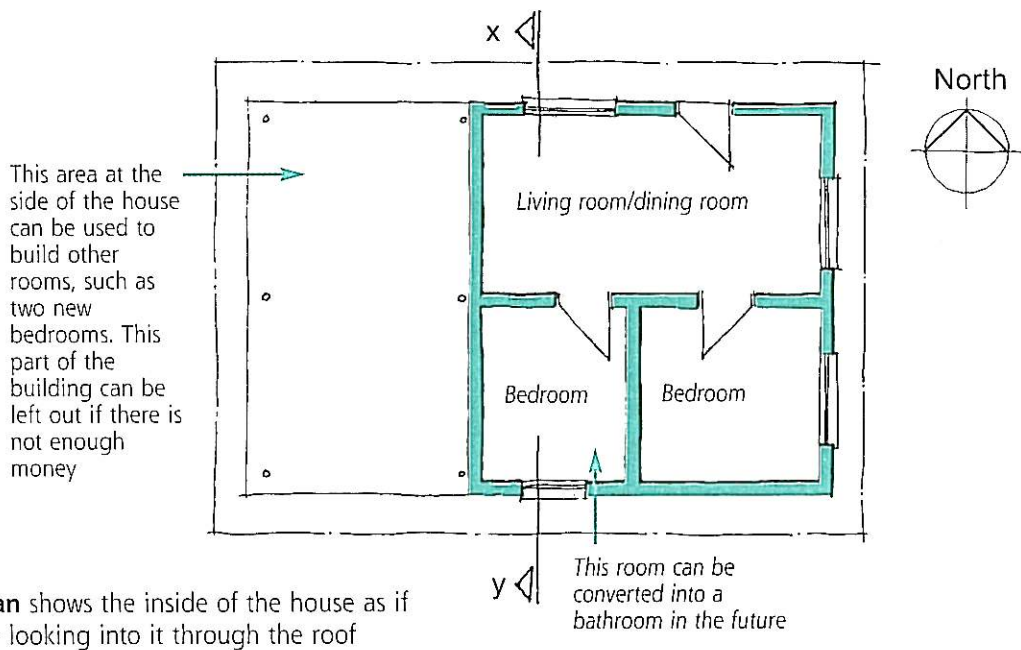

This plan shows the inside of the house as if you are looking into it through the roof

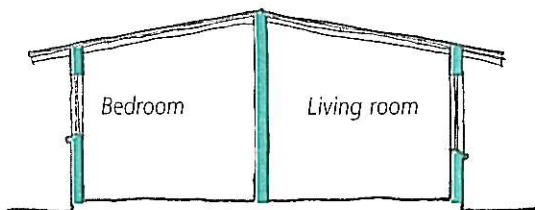

Cross-section through the living room and the bedroom, from points x and y shown on the plan

Area of house without additional roof area (starter house): 39 m²
 Area of extension: 24 m²
 Area of house with additional rooms: 63 m²

0 1 2 3 4 5 m

This length on the drawings represents one metre on the ground

Foundations

The foundation is the part of a building that is in contact with the ground and that supports the walls and roof. It is important to provide good foundations because it is very difficult and expensive to repair them after the house has been built.

The type of foundations you need will depend on the ground conditions. If the house is to be built on solid rock you may not need any foundations. This section shows how to build foundations on ground that is 'stable' (not likely to move). One way to judge the ground conditions is to look at other houses in the area - if their walls are cracked this may be because of ground movement. If in doubt, ask a building inspector for advice about the ground conditions and the type of foundations that would be suitable for the site.



This is an attempt to build foundations after the wall had been built

Common problems

- House walls may crack if:
 - the house was built without foundations;
 - the foundations were not suitable for the ground conditions;
 - the foundations were not dug deep enough into the ground and so were weakened by erosion of the soil around them;
 - the ground under the foundations on one part of the building was softer than the ground under the other foundations, so the walls cracked when the foundations on the softer ground sank down further than the others.

Some solutions

- Make sure that:
 - the foundations are wide and thick enough for the size of the building;
 - the foundation trench is deep enough so the foundations are laid on firm ground;
 - the foundations are level and are built under the whole length of each wall;
 - the foundations are stepped if the ground slopes (see *The Site*, page 19);
 - the foundation walls are built along the middle of the foundations.

Building the foundations

Check the ground conditions before starting. The foundations shown on this page are suitable for 'normal' ground conditions and single-storey houses.

1. After preparing the site (see page 19), mark out where the house walls are to go. The foundations will be built below each wall.
2. Use string to mark the position of a trench for each foundation wall. Then dig out the trenches. The width of the trenches should be 600 mm or more. The bottom of the trench should be on firm ground and 500 mm or more below ground level. If the ground is very soft, you may have to dig deeper than 500 mm to reach firm ground. Make sure that the bottom of each trench is level and that there are no stones or loose soil.
3. Cast the foundations in the trenches. The drawings below show different ways this can be done. Always use good, solid, water-resistant materials for the foundations. Make sure the foundations are 200 mm thick or more.



Making trenches for the foundations



Local stone can be used to make foundations

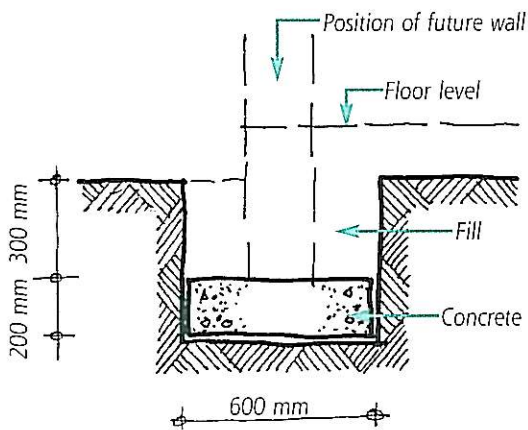

Using concrete for normal foundations. The concrete should be 200 mm thick or more

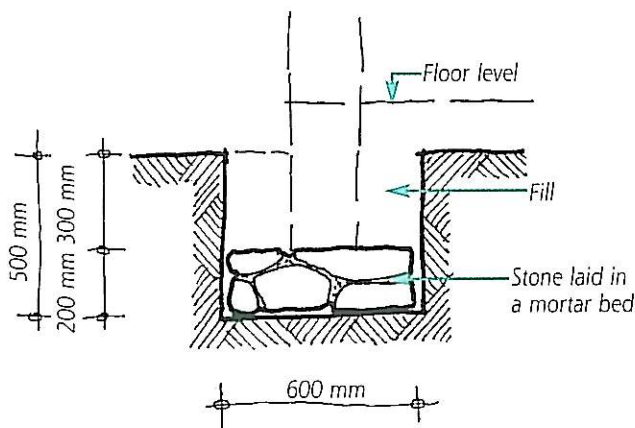

Using local stone, set in a mortar made from soil and cement. The rocks or stones should make a layer 200 mm thick or more

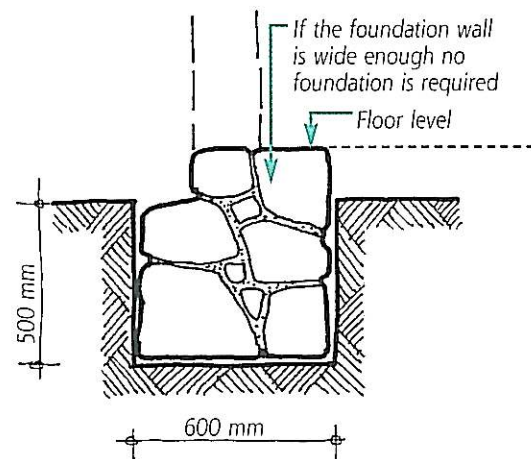

This foundation wall is so wide that a separate foundation is not needed

Foundation Walls

Foundation walls are built between the foundation and the floor. They support the walls that are above floor level, so they need to be strong.

Foundation walls will get damp because they are built partly below ground level. Therefore, they must be built from material that will not soften and collapse when wet.

The top of the foundation walls must be at least 150 mm above the highest ground level. This, together with a damp-proof course (see *Damp-proofing*), will help to stop water from the ground rising into the floor and walls of the house.

If you are building on a slope, see the drawings in *The Site* on pages 19 and 20. These show how a foundation wall can be used as a retaining wall on steep slopes.



Building foundation walls with stabilised earth blocks

Common problems

- Foundation walls can crumble and collapse if they are made of unstabilised earth blocks or other material that softens when it gets wet.
- House walls can sag, crack or even fall over because the foundation walls are too weak to support them.



This foundation wall was made from unstabilised earth blocks which have started to collapse

Some solutions

- Always build foundation walls from materials that will not weaken if they get wet, such as:
 - strong cement-stabilised earth blocks;
 - local stone and cement mortar;
 - 'normal' concrete blocks or bricks or;
 - burnt clay bricks.

The drawings on the next page show how these different materials can be used to build strong foundation walls.

- For extra strength a double wall of bricks can be used in the foundation wall, see drawing on page 33.

Different ways to build foundation walls

Make sure that you build foundation walls out of suitable materials that will not soften or weaken if they get wet. Some suggestions are given in the drawings below.

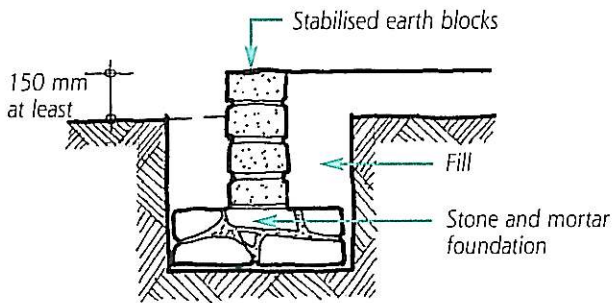

Well-stabilised earth blocks with cement mortar

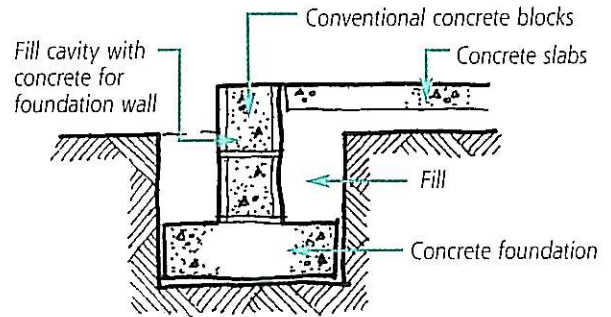

Concrete blocks or bricks

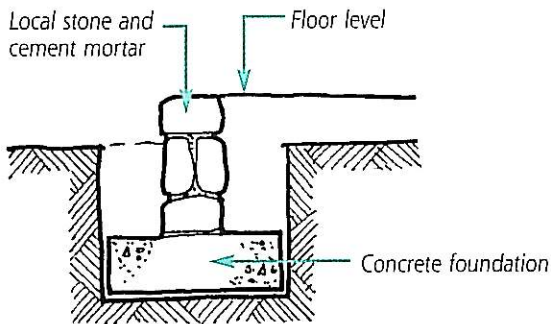

Local stone and cement mortar

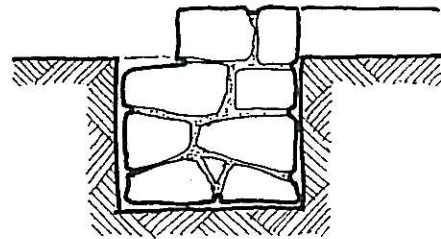

If the foundation wall is at least 600 mm wide, no foundation is needed

Floors

Floors have to support people walking on them, furniture and other objects. They need to be built so they are strong, can be cleaned regularly and do not get damp.

The floor level of a house should be 150 mm or more above the ground. On a sloping site, the ground on the up-hill side should be cut away so that no soil is banked against the outside of the walls above floor level (see page 19).



A traditional cow dung floor

Common problems

- Earth or concrete floors can crack because of settlement (the ground under the floor sinking). Settlement is common in certain types of soil, but it also happens if the soil the house is built on has not been compacted properly.
- The floors and walls can get damp if the outside ground level is higher than the floor.
- Some floors wear out easily from people walking on them and from regular washing and cleaning.
- Cracks or holes in floors let insects, rats or mice into the house which may cause damage or spread disease.
- Earth floors can make a lot of dust which can get into the air and settle on furniture, clothes and food. This can be unpleasant to live with and even cause breathing problems.
- Floors can get wet if the water table is too high.

Some solutions

- Make sure that the ground is well prepared before building the floor. Remove the topsoil and compact the soil well, particularly where the ground has been built up, such as on slopes. This will help to avoid problems caused by settlement.
- Slope the ground around the house away from the walls so that rain-water drains away from the walls easily.
- Build the floor 150 mm or more above the ground (see page 19). If this is not possible, use a vertical damp-proof course on the walls (see page 33).
- Below the floor put a hardcore barrier of small stones (good for concrete floors) or a horizontal waterproof membrane (good for earth floors) (see *Damp-proofing*). This will help to protect the floor from rising damp. If the water table is too high, put a damp-proof membrane under the whole floor.
- If a seat is to be built next to an outside wall, protect the wall from water by sloping the seat away from the wall and by using a damp-proof course in the wall (see page 33).
- If you are not going to put screed on a concrete floor, then make sure the concrete is smooth.

Floor levels

Build the floor 150 mm or more above ground level to help stop water running into the house when it rains.

On steep slopes, a split-level floor may be needed (see *The Site*, page 20). This means the floor in one part of the house is lower than the floor in another part of the house. The wall between the two floor levels must have a vertical damp-proof course to stop the lower floor getting damp from water moving through the wall (see page 33).

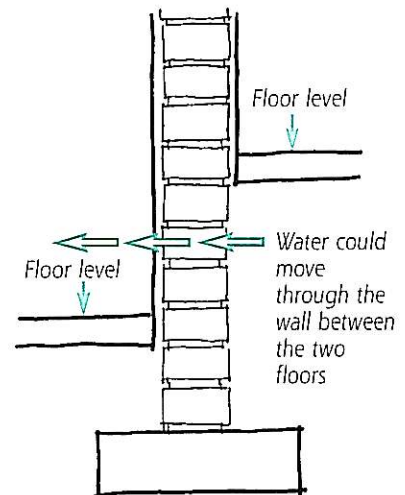

A split-level floor

Floor finishes

There are many different types of floors and floor finishes. Some floors are made of compacted earth and a mixture of cow dung and soil is used as a finish. Others are made of concrete which is harder and lasts a long time. Concrete floors can be smoothed off and polished, tiled or carpeted. Floors made of earth and other 'soft' material need to be maintained regularly to keep them in a good condition.

The blocks were laid in a stabilised soil mortar bed with rounded joints

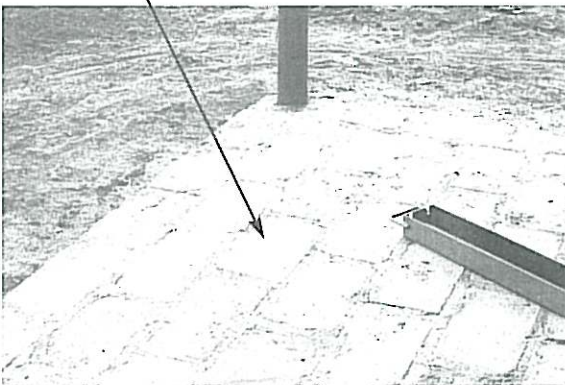

A floor made from stabilised soil blocks

This floor was laid on a bed of stabilised soil, on top of a damp-proof membrane (DPM). Small stones (up to 70 mm in diameter) were set in a cement mortar. The floor was floated with a steel float to get a smooth finish

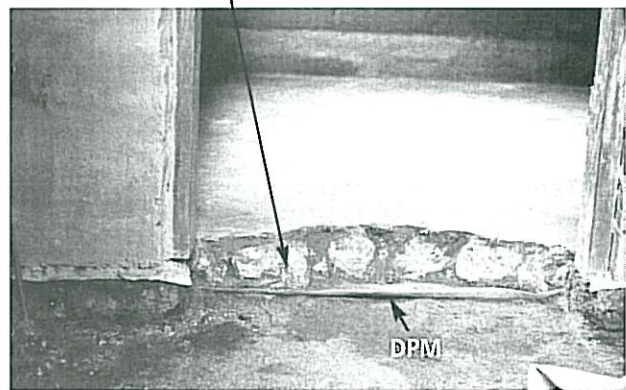

A floor made with local small stones

Damp-proofing

Damp in a house can cause serious structural problems and damage the wall or floor finishes. Damp can also affect the health of the people living in the house (see page 20). One way to protect a house from damp is to put a waterproof barrier in the walls and under the floor.

A damp-proof course (DPC) is a barrier that is built into a wall to stop water moving up, or through, the wall. A special black plastic is usually used for the DPC. It comes in rolls of different widths to suit the thickness of different walls.

It is very important to put a DPC on top of the foundation wall at floor level. This protects the walls above the floor from any water from the ground that may rise through the foundation walls. It is also good practice to put a DPC in other places in the building that may get wet, such as under window sills (see page 39).

A damp-proof membrane (DPM) is a large plastic sheet that is put under a floor to stop water moving up from the ground into the floor. This is sometimes called an under surface bed (USB) membrane. It is important to make sure that the DPM is laid under the whole floor.



A damp-proof course has been put in the wall of this house

Note: Strips of flat, galvanised sheet iron are sometimes used for the DPC instead of plastic. But this is not good practice because in time the iron will rust and allow water through to the walls.

➤ Common problems

- Crumbling walls and damaged plaster because of damp (there may be no DPC or a DPC that is damaged or does not cover the whole thickness of the wall).
- Damaged floors or soft earth floors because of damp (there may be no DPM or the DPM may be damaged or not cover the whole floor).
- People living in the house can suffer health problems caused by damp.

➤ Some solutions

- Always put a DPC or DPM in the appropriate place in the building.
- When putting in a DPC or DPM make sure that:
 - there are no holes in the plastic;
 - the plastic covers the whole area; and
 - follow the manufacturer's instructions for joining the plastic sheets.
- A DPM must be used if the water table is high.

Where to put a damp-proof course

A damp-proof course should be put in wherever water is likely to collect or seep through the walls. This section shows the main places where a DPC and DPM are needed.

Remember: When putting in a DPC or DPM, it is important to make sure that the plastic sheeting is not damaged and that it is continuous (with no gaps). If two pieces of DPC sheeting have to be used, they must overlap by at least the width of the roll. Follow the manufacturer's suggestions when joining two pieces of DPM.

Make sure that the DPC is wide enough to cover the width of the wall and to go through the plaster.

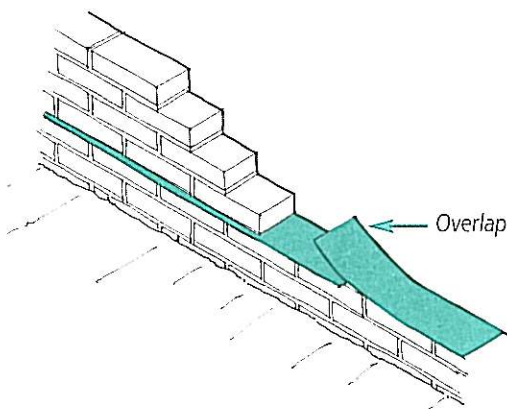

Overlapping pieces of DPC

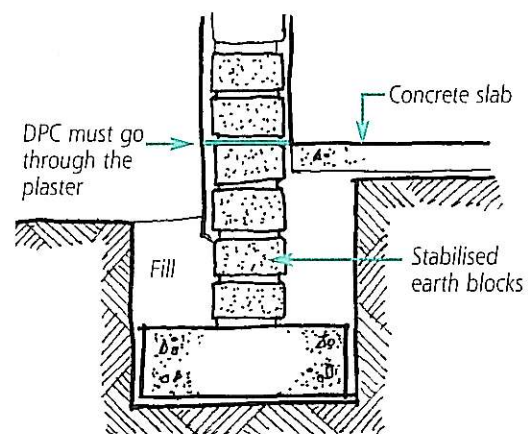

A DPC placed in the wall

At the top of the foundation walls

Make sure the DPC in the foundation wall overlaps with the DPM under the floor.

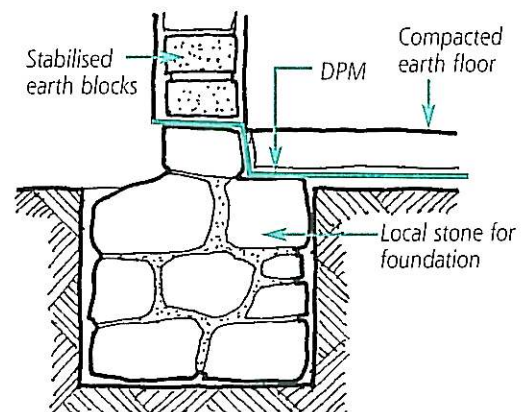
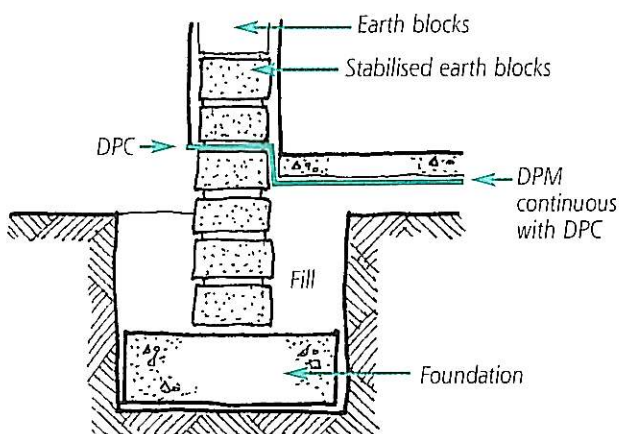

When building the walls on top of the foundation walls, make sure that both types of walls are the same thickness, and avoid having a ledge on the outside of the wall. Water can collect in the ledge and seep through the wall, as shown in the drawing below.

This drawing shows bad practice!

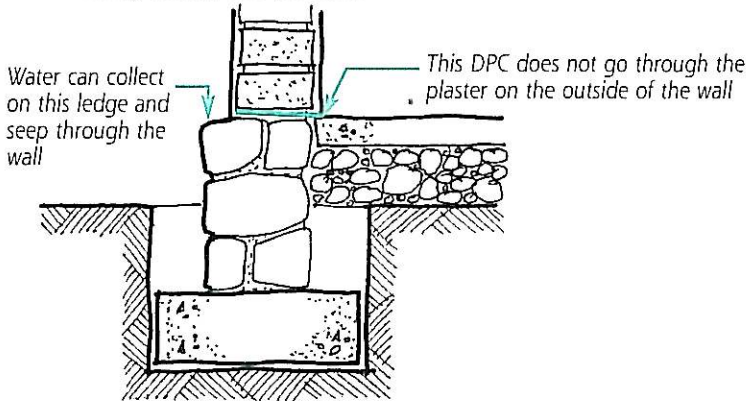

Under a floor

The last two drawings on page 31 show how a DPM can be placed under the floor and overlapped with the DPC in the foundation walls.

The drawing below shows how a layer of hardcore can be used under a concrete floor instead of a plastic DPM. A plastic DPC must still be used at the top of the foundation walls.

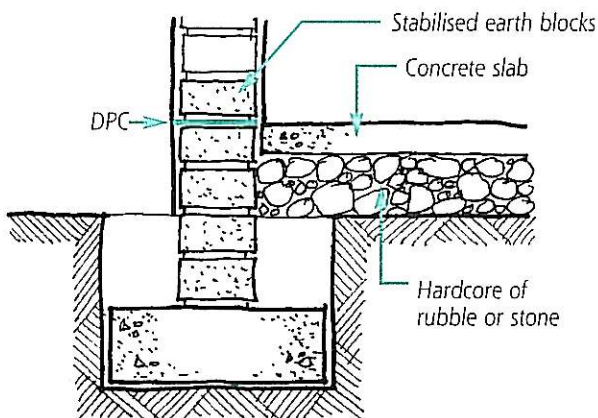

Under the window sill tiles

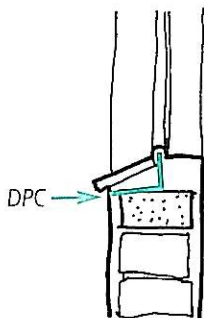

In split-level floors

A vertical DPC should be put up the middle of the foundation wall between the two floor levels. This stops water from the ground seeping through the wall. A DPM is also recommended under both floors.

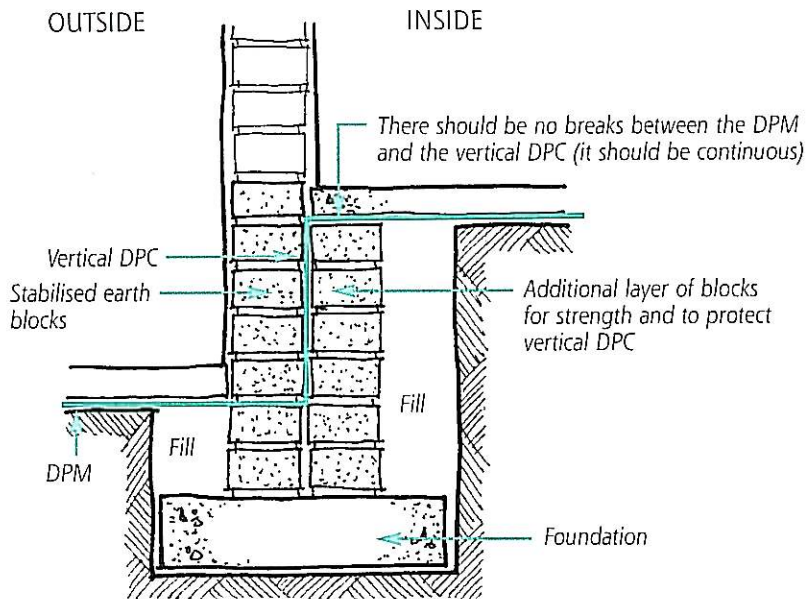

Behind a bench on an outside wall

If there is a bench or ledge on an outside wall, water may collect at the back of the bench and seep into the wall. To avoid this, make sure that the top of the bench slopes away from the wall so that rain-water can run off the bench. Also put a vertical DPC in the wall at the back of the bench and fold it into the wall at the top of the bench and lower down where it overlaps with the DPM.

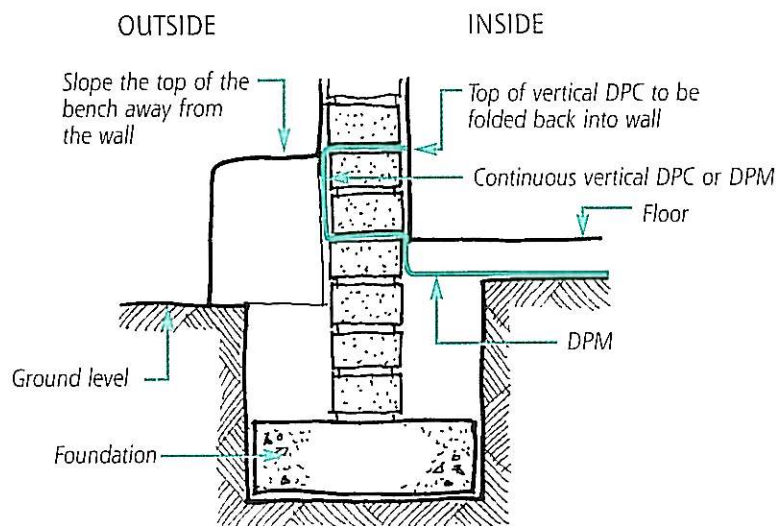

Walls

Inside the house, the people and their possessions are protected from the weather by the house walls and roof. The walls have to support the roof and hold the door and window frames in position. But the main thing the walls have to stand up against is the wind. The walls have to be strong enough to stop the house from being blown down.

The strength of the walls will depend on their size, as well as the material they are made of. It is important to make sure that the walls are built to the length, height and thickness that is most suitable for the size and design of the house. For the type of house described in this guide, the walls should be either 200 mm or 250 mm thick and strengthened with reinforced concrete ring-beams. Ring-beams tie the walls together and also help to make them stronger (see Ring-beams). Use the guidelines on pages 48 and 49 to check the design of the walls in your building.

Water can weaken the walls, so it is important to protect them from the rain and water in the ground. This can be done by using damp-proof courses (see Damp-proofing), making sure the roof overhang is wide enough (see Roof) and by putting in window sills (see Windows and Doors), gutters and down-pipes. Plaster and other finishes can also help to protect the walls (see Wall Finishes).

The superstructure (top) walls are supported by the foundations and the foundation walls, so these need to be built properly to avoid problems with the walls (see Foundations and Foundation Walls).



The Lekgophung Development Centre before the walls were plastered

Unstabilised earth blocks deteriorate very quickly if they get wet, so in some cases, it may be better to use stabilised earth blocks for building walls, or for certain parts of the wall.

Common problems

- Earth walls can crumble and deteriorate from rain and damp.
- Walls can crack because:
 - of weak bonding between the blocks;
 - the walls are not supported on strong foundations;
 - the blocks are not dried out completely before they are used to build the wall, and after the wall is built the blocks shrink as they dry.
- Often doors and window frames are loose because they were not built into the walls properly.
- Window and door frames sag because the blocks in the wall above them are not properly supported on lintels.

Some solutions

- When the walls are built, make sure that:
 - the building is designed properly and the walls are built to the right thickness, height and width (see pages 48 - 49);
 - the earth blocks used to build the walls are dry and do not have many cracks;
 - use the same mix for making the mortar as you used for the blocks, so the mortar and the blocks are the same strength;
 - the blocks in the wall are laid properly, particularly at the corners and where two or more walls join (see below);
 - the walls are built straight and upright;
 - reinforced concrete lintels are put in over all openings for windows and doors (the lintels should extend at least 300 mm beyond the edge of the window into the wall at each side of the opening, see *Windows and Doors*);
 - ring-beams are put in around the top of all the walls to strengthen the walls and hold the roof down firmly (see *Ring-beams*);
 - the roof is properly anchored to the walls (see *Roof*);
 - two courses of stabilised blocks are put in above the damp-proof course level to help protect the wall from rain-water splashing from the ground onto the walls; and
 - stabilised blocks are used around doors and window frames to help hold them firmly in position.

Block laying

When laying the blocks make sure the vertical joints are not on top of each other.

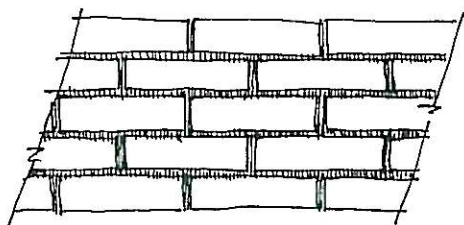

Good bonding - strong wall

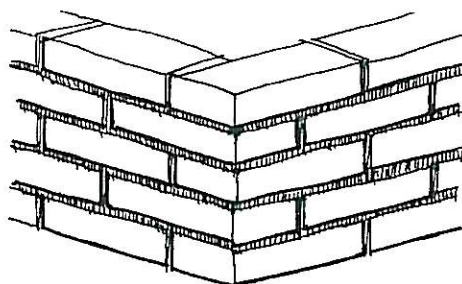

Good corner bonding - strong wall

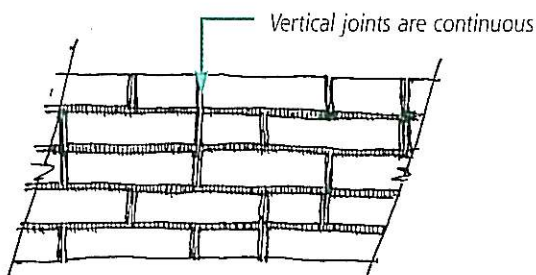

Bad bonding - weak wall

Ring-beams

Ring-beams are built along the top of all the outside and inside walls. They help to stop the house walls from blowing over in a strong wind. They also provide a firm base to which the roof is tied, so it cannot be damaged by the wind.

For the houses described in this guide, use two ring-beams, separated by two courses of blocks, along the top of each wall. Each ring-beam should be:

- made of a good quality concrete - use a 1:2:2 mix (one-part cement, two-parts sand, two-parts stone);
- reinforced with two 6 mm diameter high-tensile steel bars; and
- 50 mm thick and as wide as the wall.

Roof ties, made of 4 mm diameter galvanised wire, should be placed under the lower ring-beam. The ties should stick out on both sides of the wall and be long enough to be bent up and tied to the roof structure.

If lintels are used over windows, no shuttering above the window frame is needed when casting the lower ring-beam.

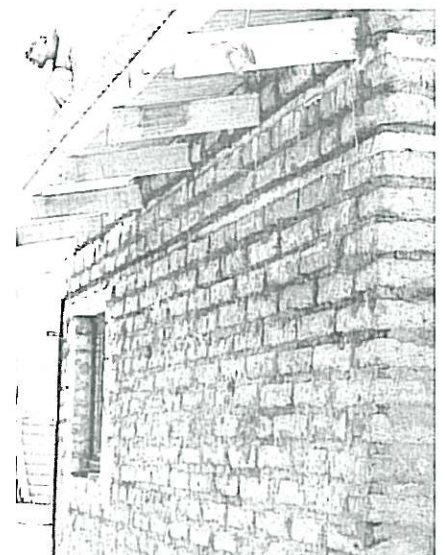
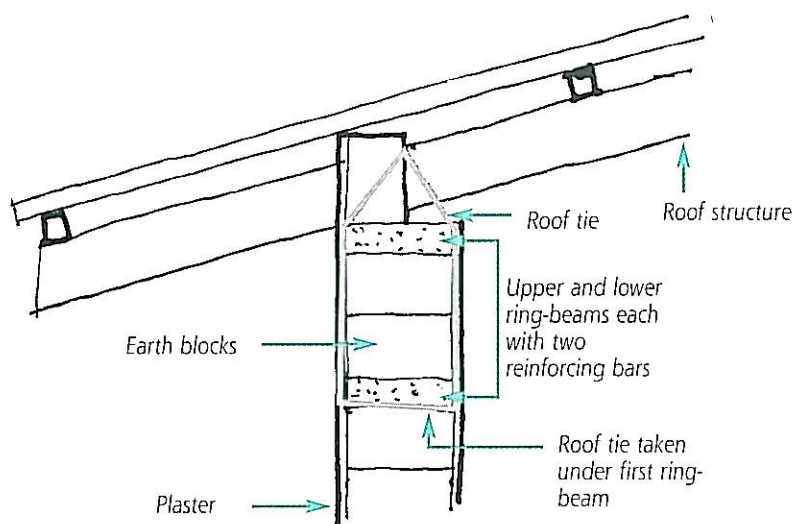

Two shallow ring-beams, with roof ties to anchor roof

Steps for making ring-beams

Step 1

Place the roof ties across the wall below where the rafters will be - they should stick out on both sides of the wall. The lower ring-beam will be cast on top of these ties.

Step 2

Make the shutters (mould for the sides of the ring-beams) using any long, straight pieces of wood or metal. Roof purlins make good shutters. They can be cleaned and used for the roof after the ring-beam has been cast.

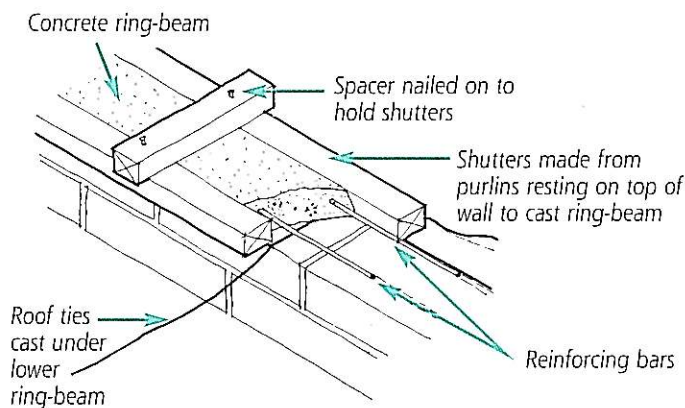

Roof ties laid on wall below ring-beam

Step 3

Position the steel reinforcing bars. The bars must overlap where the walls join.

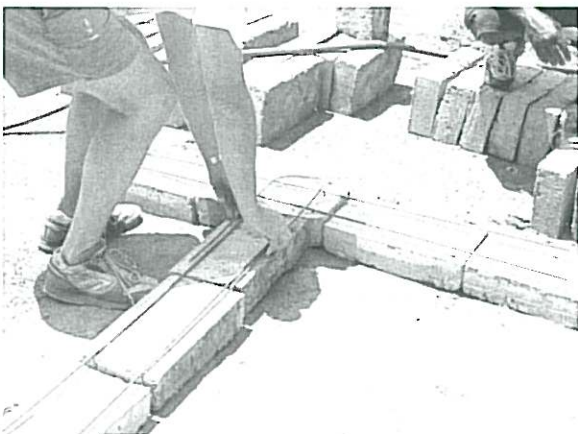

This mock-up shows how the bars in the ring-beams should overlap in the corners of the walls

Step 4

Cast the lower ring-beam and wait for it to set.

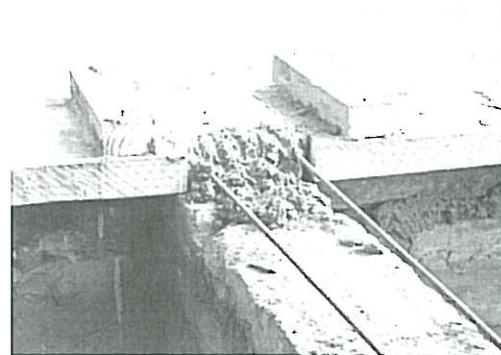

Step 5

Lay two courses of earth blocks on top of the lower ring-beam.

Step 6

Repeat steps 2 and 3 and then cast the upper ring-beam. Reinforce the upper ring-beam in the same way as the lower ring-beam. No roof ties are needed below the upper ring-beam.

Windows and Doors

Windows and doors can weaken the walls if they are not built in properly. For the type of houses described in this guide the width of a door or window opening should not be more than 1 500 mm. Doors and window frames are secured in position as the walls are built. The frames usually have lugs that can be secured in the joints between the blocks in the wall. Stabilised earth blocks around the frames and lintels help to strengthen the wall and hold the frames firmly in position.



Common problems

- The frames become loose as the windows and doors are opened and closed or banged shut.
- The seal with the plaster breaks, so rain-water gets into the wall at the sides of the window and door frames, and this softens the earth blocks.
- Windows and doors do not close properly because their frames get distorted by sagging walls which are not supported by good lintels. This can cause the whole wall to collapse.
- Plaster and earth blocks around the windows begin to crumble because there are no window sills or damp-proof course (DPC) to protect the walls from rain-water (see *Damp-proofing*).

Some solutions

- Strengthen the walls around the window and door frames by:
 - using stabilised earth blocks around the frames (see page 39); and
 - providing concrete lintels above the door and window frames which overlap the block work by 300 mm on each side of the opening.
- Make sure the frames are fixed firmly to the wall by:
 - using a strong mortar for all the joints around the window, such as a cement-stabilised earth mortar (one part cement and five parts sand or soil); and
 - filling the gap behind the pressed metal door frames with the strong, cement-stabilised mortar.
- Prevent the rain-water from getting into the wall by providing proper window sills and a DPC (see pages 39 and 31).

Window size

Windows let in light and fresh air and so help to make the house a healthy place to live. Windows need to be big enough to let in fresh air for good ventilation, but not too big (1.5 m or less) to weaken the wall structure or make the room too cold.

Strengthening walls around window and door frames

Use stabilised earth blocks around the sides and base of the window. Use a lintel (usually a concrete beam) at the top of the window frame. The lintel helps to support the wall above the window.

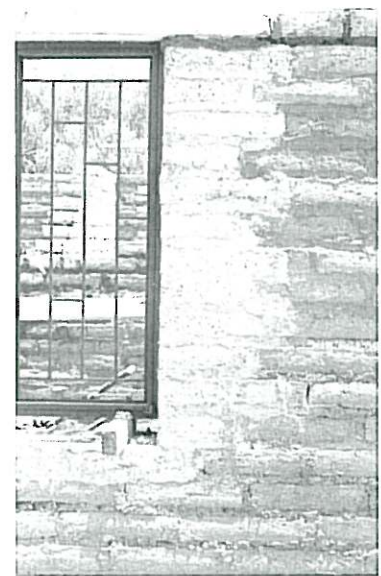
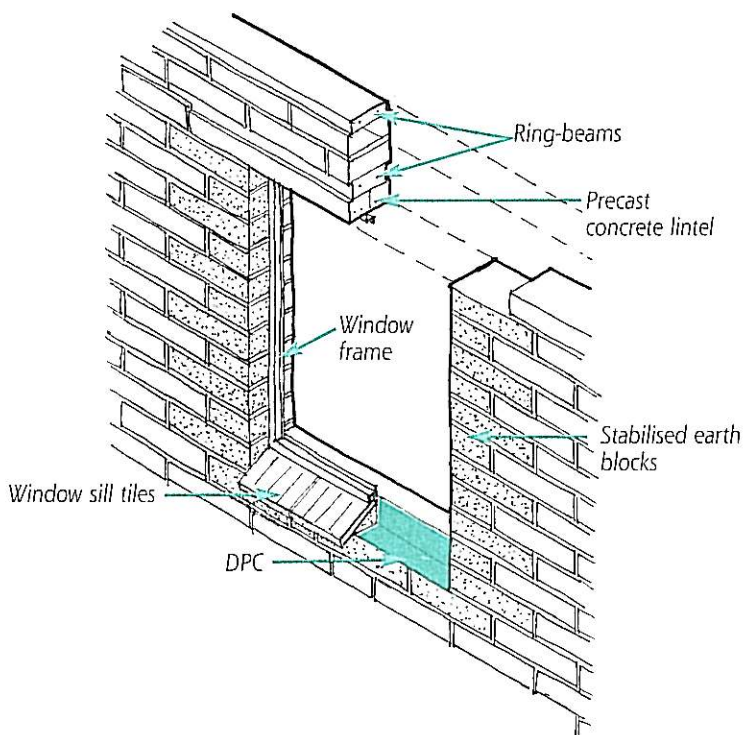

The stabilised earth blocks around this window frame were bedded in a cement mortar

Protecting the walls from rain-water

Window sills stop water collecting and running down the wall below the window frame. The sills can be made from tiles (cement or ceramic), fibre cement or bricks. Moulded plaster can also be used.

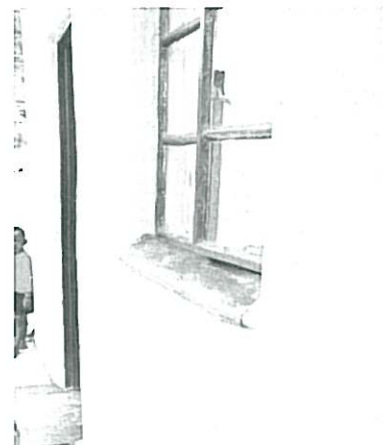

This moulded plaster sill was finished with Cobra wax polish

Roof

The roof, together with the walls, protects the inside of the house, and the people living in it, from the rain, sun and wind. However, the roof is also important for protecting the outside walls from the rain. The roof must be tied down (anchored) firmly so it does not get blown away in a strong wind.

Corrugated galvanised steel sheeting ('zinc') is often used for roof covering. This is put on a roof structure which is fixed to the walls and made from wooden beams, wooden poles, or steel channels.

The structural design for the roof of a house built with earth is the same as for a conventionally built house, except for the way in which the roof is anchored to the walls (see *Ring-beams*).



Common problems

- The roof sags in the middle because the wooden beams or poles used for the frame are too small or are in a bad condition.
- Gaps or weaknesses where the different parts of the roof meet because they have not been joined properly.
- Leaks in the roof because of holes in the roof sheeting.
- Gaps in the roof because the roof sheets are not fixed properly to the frame, or gaps between the top of the walls and the roof because the roof is not wide enough.
- Walls getting wet from the rain-water because the roof does not have a big enough overhang.

Some solutions

- Make sure that the roof is tied firmly to the wall, using the ties placed under the ring-beams (see page 36).
- Keep the roof shape simple and avoid parapet walls, so there will be fewer joins in the roof and less chance of leaks.
- If second-hand roof sheeting is used, make sure that it is not rusty or bent and has as few holes as possible. The holes can be plugged with the galvanised steel bolts and washers like the ones used to fix the roof to the timbers.
- Make the roof overhangs as big as possible to protect the walls from rain. Gutters and downpipes can also be used to take rain-water away from the wall of the house.

Roof size

People often make their roof too small because they want to save money on the roof sheeting. However, this can allow the walls to get damp and cause problems later. So, it is worth making sure that you have enough sheeting to allow for good overhangs to protect the walls.

The eaves (roof overhang) and the gable ends should extend at least 200 mm from the outside walls.

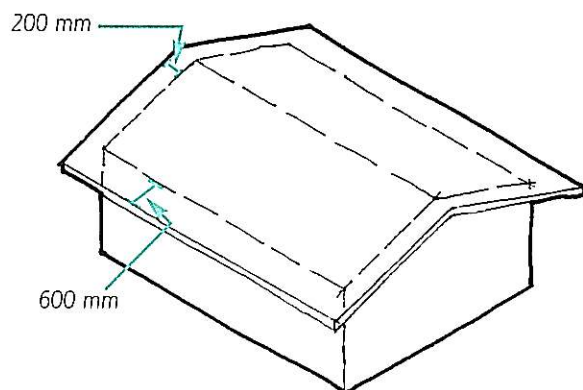

Attaching the roof

Use the wire roof ties placed under the lower ring-beam (see *Ring-beams*) to anchor the roof structure to the top of the walls.

A single piece of wire (usually 4 mm diameter wire) can be used for each tie. The ties should stick out on either side of the beam. To secure the roof, bend the ties upwards and twist the two ends together on top of the rafter. Flatten the twisted wire against the top of the rafter. Secure the wire by driving a 75 mm nail into the wood and bending it over the wire.



Wire ties fall directly below the rafter. They must be tied firmly

Wall Finishes

A wall finish protects the wall from the wind and rain. Unstabilised earth blocks quickly soften and crumble if they get wet, so they must be treated with a suitable finish that is regularly checked and maintained. Even houses built with concrete blocks or brick can leak if the joints are not made properly. Plaster also helps to make these walls waterproof.

Some parts of the house are more exposed to the weather than others, like gable ends where the roof overhang is usually very small. The wall finishes in these areas are particularly important.

Many products are available that can be used as wall finishes, such as paints and waterproof coatings. Some products can be mixed with plaster, or put on top of the plaster, others can be put on the earth blocks before, or instead of, plastering. Follow the manufacturers' instructions for using them. Ask the shop assistant for advice.



Common problems

- The plaster may come away from the walls if it is not bonded to the wall properly.
- Plaster made from earth and cow dung can crack and deteriorate if it is not maintained regularly.
- Plaster cracks if the walls crack.
- Cracked plaster lets rain-water seep into the wall. The water causes unstabilised earth blocks to deteriorate and destroys the bond between the plaster and the blocks.

Some solutions

- Use a wall finish to protect unstabilised earth blocks from the rain. Different types of finishes can be used. A good cement plaster, particularly with two coats of PVA paint, will provide very good protection for the wall. The plaster will harden well if it is kept damp for four days.
- Make sure that the plaster bonds to the earth blocks as well as possible (see page 43).
- To avoid damp rising up through the plaster from the ground, stop the plaster at the damp-proof course (DPC); or plaster down to ground level but make sure the DPC goes through the plaster (see page 31).
- Inspect the building regularly and repair any cracks you find in the plaster.

Plastering

Here are some suggestions for helping the plaster stick more firmly to the earth blocks. The idea is to make a rough surface on the wall for the plaster to grip on to.

Suggestion 1

Scrape the mortar joints

As the wall is being built, scrape the mortar joints away to a depth of 10-15 mm. When the wall is ready for plastering, apply a cement plaster. The scraped joints help to key the plaster.

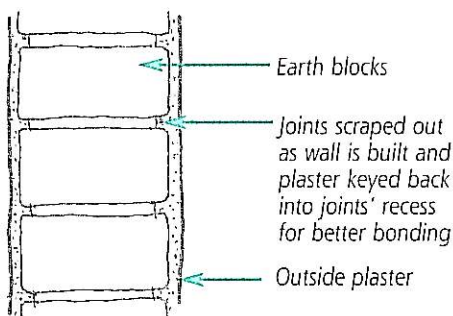

Suggestion 2

Use nails to hold the plaster

Before plastering, hammer 75 mm long nails into the walls but leave the heads sticking out. Space the nails about 300 mm apart along and up the wall. You could go on to link the nails together by winding galvanised wire (0.5 mm thick) around them. Then cover the walls and nails and/or wire with plaster.

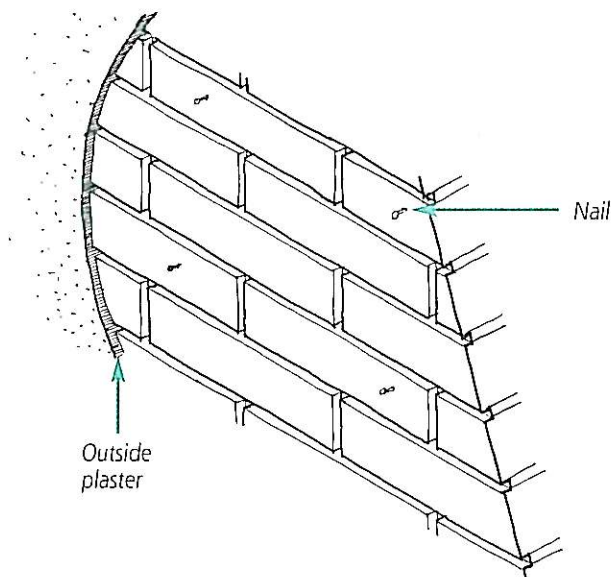

Suggestion 3

Use chicken wire

Nail chicken wire onto the wall before plastering. The chicken wire can be placed over the whole of the outside wall or just around the outside corners of the building.

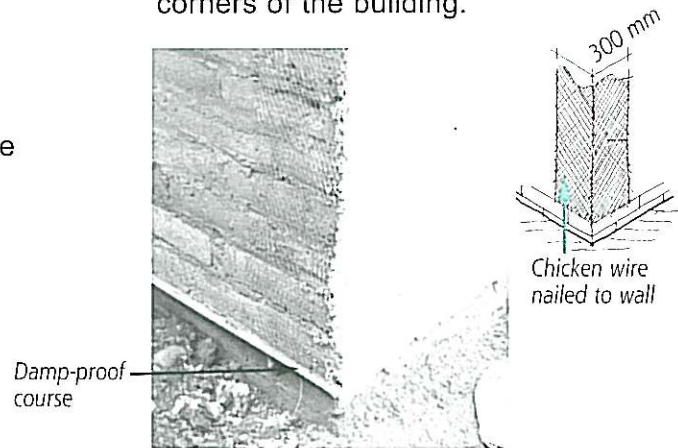

Chicken wire nailed to the wall at corners before plastering. This wall was only plastered above the damp-proof course

Suggestion 4

Using a linseed oil and mineral turps mixture

As the wall is being built, rub it down to get a fairly uniform surface. A mixture of one-part linseed oil and one-part turps can then be applied to the new surface and brushed in. This mixture must be reapplied each year.

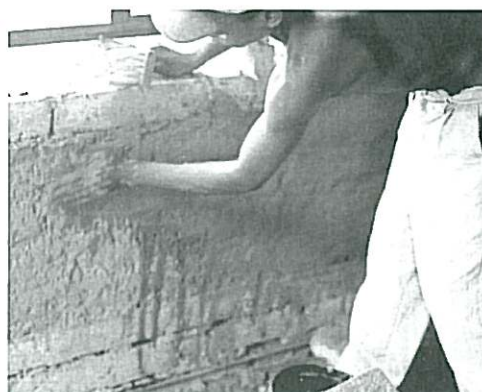

Smoothing the wall before applying the oil mixture

Ceiling

A ceiling can help a room look pleasant and bright. It also prevents dust from falling into the room from the roof. However, one of the most important things about a ceiling is that it helps to control the temperature of the room.

In summer, a ceiling helps to keep the room cool because it stops the heat from the sun on the outside of the roof getting into the room. In winter, a ceiling helps to keep the room warm because it stops the heat from inside the room escaping through the roof. Putting some type of insulation above the ceiling will make it much more efficient in this temperature control function.

Ceilings also help to protect the roof sheeting from condensation. For example, in a room with no ceiling the steam from cooking or hot bathwater rises and the water collects on the underside of the roof as the steam cools (condenses). After some time this water can make the roof sheeting rust. It can also make the house damp which can be unhealthy.

Ceilings can be installed the same way in an earth block house as in a conventionally built house. For this reason, no details for installing ceilings are given in this guide. An experienced builder will be familiar with the more commonly used ceiling materials and how to erect them.



The Lekgophung Development Centre

Maintenance

All houses need regular maintenance to keep them in good condition. After a house is built there are many things that can affect them, such as:

- ground movements (such as subsidence) which can cause cracks in the walls;
- changes in the water table (the level of water in the ground below the house);
- different weather conditions – very cold or hot, wet or dry, calm or windy;
- the activities of the people who live in the house, such as washing floors, opening and closing doors and windows; and
- the way in which the different building materials used work together, for example, strong plaster on weak blocks.

It is a good idea to inspect the house regularly. Look out for things like cracks in walls, and water collecting against the walls. After a bad storm check the house for any damage. If something is wrong, find the cause of the problem and repair the damage before it gets worse.

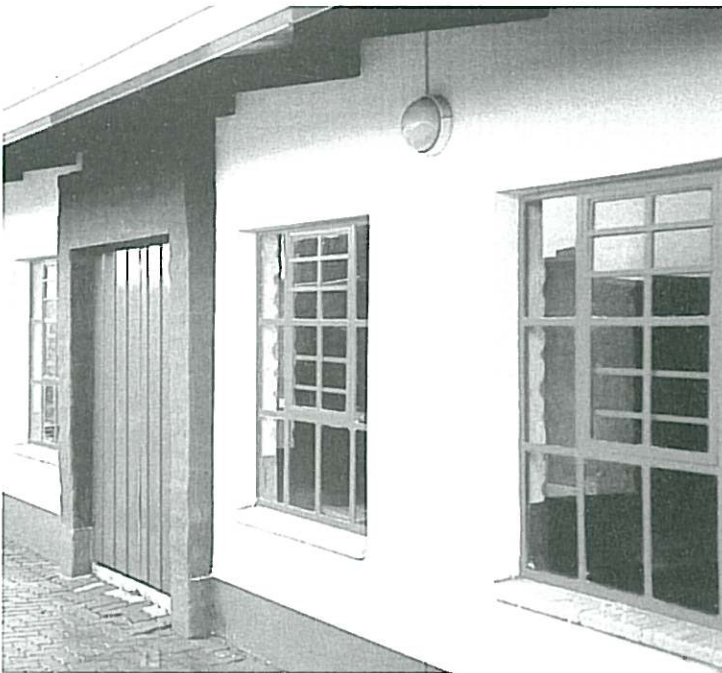

The Housing Support Centre, Waterloo

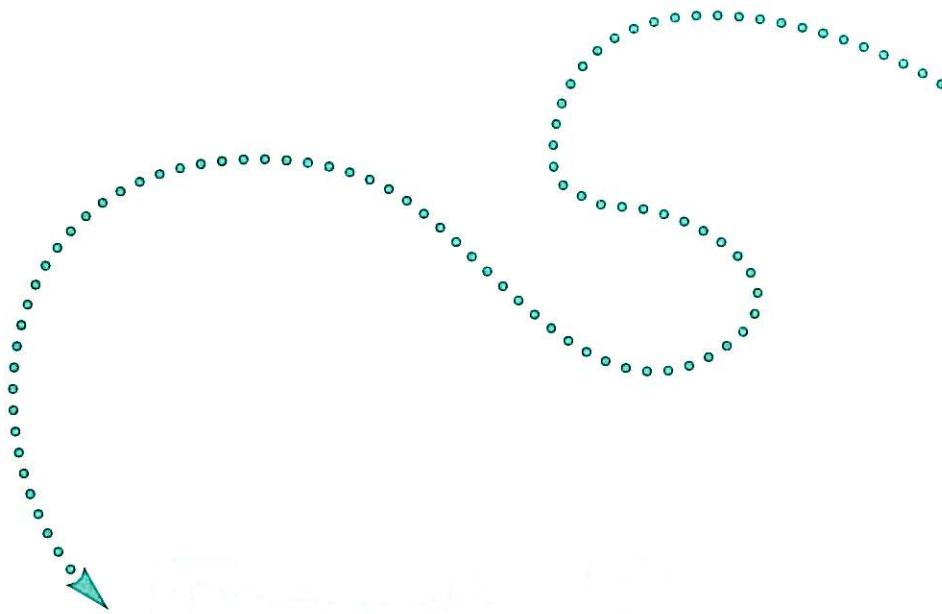

This part of the guide gives structural design guidelines and criteria that you can refer to when designing a house. It also includes a glossary that explains some of the technical words used in the book.

Guidelines for the Structural Design of Houses

The strength of a house depends on the building materials used and the structural design of the house. The structural design includes the size of the walls, size and position of the window and door frames, and the slope of the roof. This section gives guidelines for the structural design of houses built with earth blocks. The structural design criteria used to calculate these guidelines are given on pages 50-51.

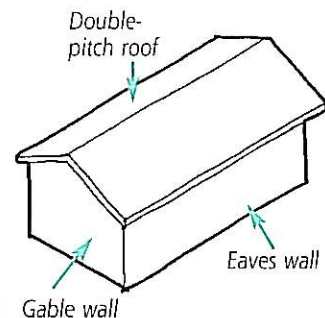

Houses built with earth blocks 200 mm thick and reinforced concrete ring-beams to strengthen the walls

- There should be at least two courses of blocks between the ring-beams.
- Each wall should have two **ring-beams** with 200 mm or more between each ring-beam. Each ring-beam should be 50 mm deep and 200 mm wide, and reinforced with two Y6 reinforcing bars.

Height of each eaves wall: Not more than 2.5 m

Measure the height between the top of the floor and the underside of the roof trusses.

Length of each gable wall: Not more than 6.5 m

Use a double-pitch roof, with a slope flatter than 15 degrees.

Length of each eaves wall: Not more than 8 m

Measure the length between the supporting walls.

Length of internal walls: 1.3 m or more

These walls need to be at least 1.3 m long to support the eaves walls.

The thickness of the walls must be 200 mm or more.

The height of the walls must be 2.4 m or more.

Width of door or window opening: Not more than 1.5 m

Width of wall between any two openings (doors or windows):

0.4 m or more if the roof supported by the wall spans 1.5 m or less.

0.6 m or more if the roof supported by the wall spans 3.5 m or less.

0.8 m or more if the roof supported by the wall spans 5 m or less.

1.2 m or more if the roof supported by the wall spans 6.5 m or less.

Houses built with earth blocks 250 mm thick and reinforced concrete ring-beams to strengthen the walls

Each wall should have two **ring-beams** with 200 mm or more between each ring-beam. Each ring-beam should be 50 mm deep and 250 mm wide, and reinforced with two Y6 reinforcing bars.

Height of each eaves wall: Not more than 2.5 m

Measure the height between the top of the floor and the underside of the roof trusses.

Length of each gable wall: Not more than 8 m

Use a double-pitch roof, with a slope flatter than 15 degrees.

Length of each eaves wall: Not more than 12 m

Measure the length between the supporting walls.

Length of internal walls: 1.3 m or more

These walls need to be at least 1.3 m long to support the eaves walls.

The thickness of the internal walls must be 200 mm or more.

The height of the internal walls must be 2.4 m or more.

Width of door or window opening: Not more than 1.5 m

Width of wall between any two openings (doors or windows):

0.3 m or more if the roof supported by the wall spans 6.8 m or less.

0.4 m or more if the roof supported by the wall spans 8 m or less.

Structural Design Criteria

Information for structural engineers

The criteria used in this book for the safe design of houses are outlined in this section. The criteria are sensitive to the context of rural housing, the experience of traditional 'mud block' building methods and the high standards imposed on houses built in the formal urban areas.

The lower strengths of unstabilised earth blocks are recognised in the calculations, with an average compressive strength of about 1MPa being considered acceptable. The greatest force that is likely to be imposed on a house is the wind. The criteria outlined below will adequately satisfy the performance (needs) of the house by using design features such as ring-beams, restriction of the sizes of openings (such as windows and doors), and wall lengths and thicknesses.

If the local conditions are considered in any way abnormal, then speak to your local technical advisor or structural engineer who will help to change the design of the house as necessary.

The criteria are as follows:

- Regional basic wind speed of 40 m/s.
- Terrain category 3 as defined by SABS (South African Bureau of Standards) 0160-1989. That is:
"Terrain having numerous closely spaced obstructions generally having the same size as domestic houses. (This category includes wooded areas and suburbs, towns and industrial areas, fully or substantially developed)."
- Mean return period of one in 50 years.
- No wind load reduction for altitude. That is, all dwellings are assumed to be at altitudes of between sea-level and 500 m.
- Houses are assumed to be remote from any local topography which might increase the local wind speed (such as funnelling or edges of escarpments).
- Note a deviation from SABS 0160-1989 is assumed. The wind speed multipliers are assumed to reduce for heights below 7.5 m above ground level. The design wind pressure on the house as a whole will be based on an extrapolated wind speed multiplier for a height

of 3.5 m above ground level. The value of this wind speed multiplier is assumed to be 0.455. This is equal to a wind speed (velocity) of 18.2 m/s (65.5 kph) at 3.5 m above ground level. (Note that this is the wind speed at the service limit state.)

(The wind speed multiplier of 0.455 is 71% of that given by Table 5 of SABS 0160-1989 for heights up to 5 m. This in turn results in a design free stream velocity pressure for a single-storey house that is 50% of what it would have been had it been calculated strictly in accordance with SABS 0160-1989).

- The house should be able to withstand ultimate limit state wind forces. Ultimate limit state wind forces are equal to 1.3 times the service limit state wind forces. The ultimate limit state wind velocity is 20.8 m/s (74.7 kph) at 3.5 m above ground level. This velocity will result in a free stream velocity pressure of 260 Pa at 3.5 m above ground level.
- Where the self-weight of the walls and roofs act to reduce the effects of the ultimate wind pressure, these self-weights shall be reduced by multiplying them by a factor of 0.9.
- The final results/load effects should be in keeping with the seriousness of the initial event. For example, if a window is left open, or has been broken and a wind storm occurs, or if a window is broken by a wind-blown object during the storm, then the additional wind loading on the house due to the house now having a 'dominant opening' should not cause the house to fail. Therefore the design of a house should anticipate and make due allowance for a 'dominant opening' the size of a large broken window.
- When calculating the internal pressure in a house due to a dominant opening on the windward side of that house, it is considered reasonable to use the wind pressure pertaining to the height of the top of that opening. For single-storey houses built on relatively flat platforms, it is reasonable to assume that this height will be about 2.6 m above ground level. This will result in a free stream velocity pressure of 75% of the free stream velocity pressure at 3.5 m above ground level.

Glossary

Anchored	held down or in position		
Binder	binders, like cement and lime, glue sand particles together to produce stronger and more durable blocks		
Block course	blocks are laid in regular layers which are known as courses		
Block gauge	the height of one course plus the thickness of the mortar joint		
Compacting	to make soil or block mix harder and denser by stamping or making so that the air trapped between particles of sand is driven out		
Curing	a process that helps to stop blocks from drying out too quickly so that they become stronger		
Damp-proof course (DPC)	the layer of plastic that is laid between block coursing to stop the movement of water through or in a wall		
Damp-proof membrane (DPM)	does the same job as a DPC but is in larger sheets and is placed under a concrete floor slab or earth floor		
Eaves	part of the roof that extends outwards beyond the line of the eaves wall		
Fill	the ground or material that is built up and compacted behind a retaining or foundation wall in order to make a level platform on which to construct a floor		
Force	a stress or load exerted on a structure, for example by wind, that has to be resisted by the structure		
		Gable	the part of an outside wall that extends up to the top of a roof, usually in the form of a triangle
		Grouting	the filling of a small space, such as between blocks, after the wall has been built by compacting a damp (hardly wet) cement sand mixture well into the space
		Hardcore (barrier)	a layer 100-150 mm thick of broken stones or rubble on which a concrete floor slab is cast. The sizes of the stones and the spaces between them, prevent water from moving upwards through capillary action to make the floor damp. It does the same job as the DPM
		Lintel	the small beam, usually precast concrete, that is put across the top of window and door openings and which carries the weight of the wall above it
		Lugs	pieces of metal that are fixed to door and window frames that stick out and get built into the mortar joints between the blocks to secure the frames firmly into the wall
		Mortar (daga)	mixture of soil, sand and binder that is used to bond the blocks as they are laid in courses
		Orientation	the positioning of a house on a site relative to the points of a compass, topography and view, for example positioning the front of the house, so it is facing north

Purlin	part of the roof structure, a purlin is a piece of wood (usually 50 mm x 76 mm in cross-section), to which the roof sheeting is secured		been compacted properly; <i>or</i> 2. the sinking of the ground because of the weight of the house on it
Rafter	a wooden beam that is part of the roof structure that spans between walls and carries the purlins on which the roof sheeting is fixed	Shutters	temporary wood or steel moulds into which concrete is cast. The shutters are removed after the concrete has been cast
Reinforced concrete	concrete that is usually strengthened by placing steel bars in it to counter tension forces	Stabilised blocks	soil blocks with either cement, lime or bitumen emulsion added to make stronger blocks
Ring-beam	the beam that runs around the top of all the walls in order to tie them together and make the house stronger	Structure	a building or parts of a building that can be identified separately
Rising damp	the movement of water up from the ground into the walls	Water table	the level or depth of underground water. A high water table can be seen when pools of water remain on the ground for a long time and the soil is always wet. Water tables move up and down because of seasonal rainfall periods
Screed	a mixture of river sand and cement that is laid on top of a concrete floor. It is level and smooth	Zinc	galvanised steel roof sheeting, usually corrugated
Settlement	1. the sinking of fill, under a floor slab, because it has not		

Further reading

The following publications have informed the development of this guide. They are useful reference books for finding out more about building with earth.

Earth-wall Construction (Bulletin 5) G.F. Middleton, 4th edition, revised by L.M. Schneider, Division of Building, Construction and Engineering, CSIRO, Australia (1987)

Earth Construction: A comprehensive guide, H. Houben and H. Guillaud, Intermediate Technology Publications, London (1994)

Building with Earth: A Handbook, J. Norton, Intermediate Technology Publications, London (1986)

Choosing soil for block making, in 'Practical construction advice for developing countries', Overseas Information paper, Building Research Establishment (BRE), Watford, UK, (May 1990)

Appropriate technology - adobe construction: A research and demonstration project on the use of adobe for low-cost housing construction, J.L. Arrigone, National Building Research Institute, CSIR, Pretoria (1986)

Mud brick construction, S. Burroughs (unpublished)

Mud brick training manual, S. Burroughs (unpublished)

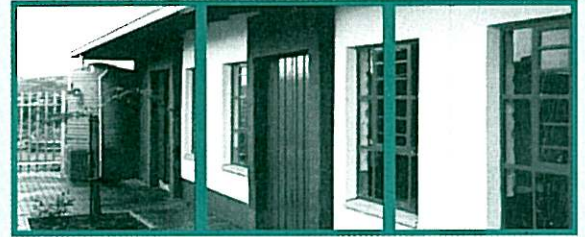

This guide is for anyone involved in building houses in rural areas, including those building their own homes and local or district council officers who provide technical support. It shows how earth blocks can be used to build strong, long-lasting houses that are affordable for people living in rural areas.

The building methods described in the book are based on traditional building methods which have been upgraded so that houses last longer and need less maintenance, but with minimum increase in cost. The methods were developed and tested in the North West Province and KwaZulu-Natal, but can be applied to other areas of South Africa.

For more information contact:
CSIR Building and Construction Technology
P O Box 395, Pretoria 0001
Tel: (012) 841-3871/4550/2626
Fax: (012) 841-4680

BOU/E0103
May 2001