

Generation and application of high power Flattened Gaussian Beams

A. Forbes^{1,2,3}, N. du Preez⁴, I.A. Litvin^{1,3} and L.R. Botha^{1,3}

¹ CSIR National Laser Centre

² School of Physics, University of KwaZulu-Natal

³ School of Physics, University of Stellenbosch

⁴ SDILasers (Pty) Ltd

Presented at the
2009 South African Institute of Physics Annual Conference
University of KwaZulu-Natal
Durban, South Africa
6-10 July 2009



Flattened Gaussian Beams (FGBs) change shape as they propagation

$$U(r, z) = U_0 \exp\left(-i(\Phi(p, z, w_0) - kz - kr^2 / 2R(p, z, w_0)) - (r / w(p, z, w_0))^2\right) \\ \times \sum_{n=0}^p C_n(p) L_n\left(2(r / w)^2\right) \exp(-2in\Phi(p, z, w_0))$$

$$C_n(p) = (-1)^n \sum_{m=n}^p \binom{m}{n} \frac{1}{2^m}$$

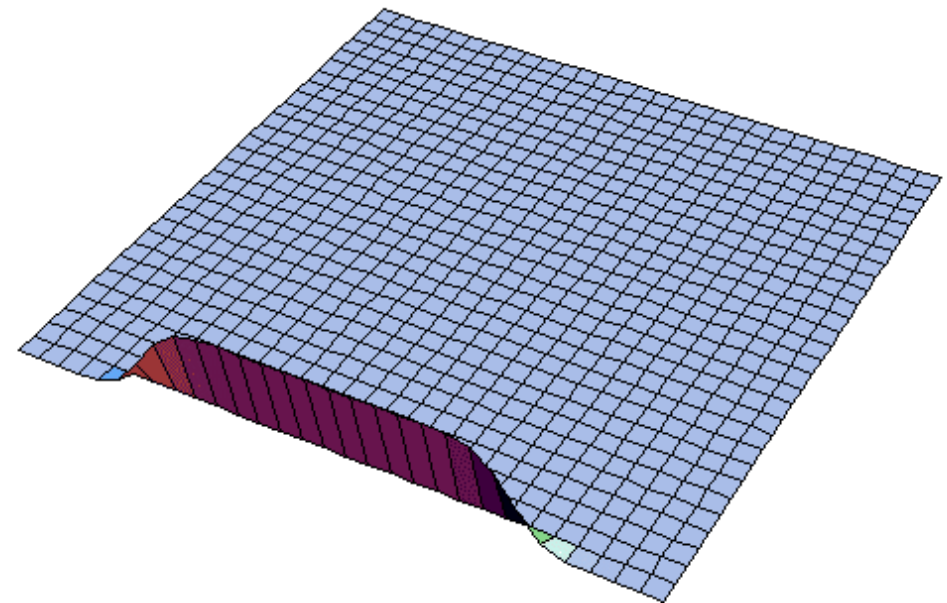
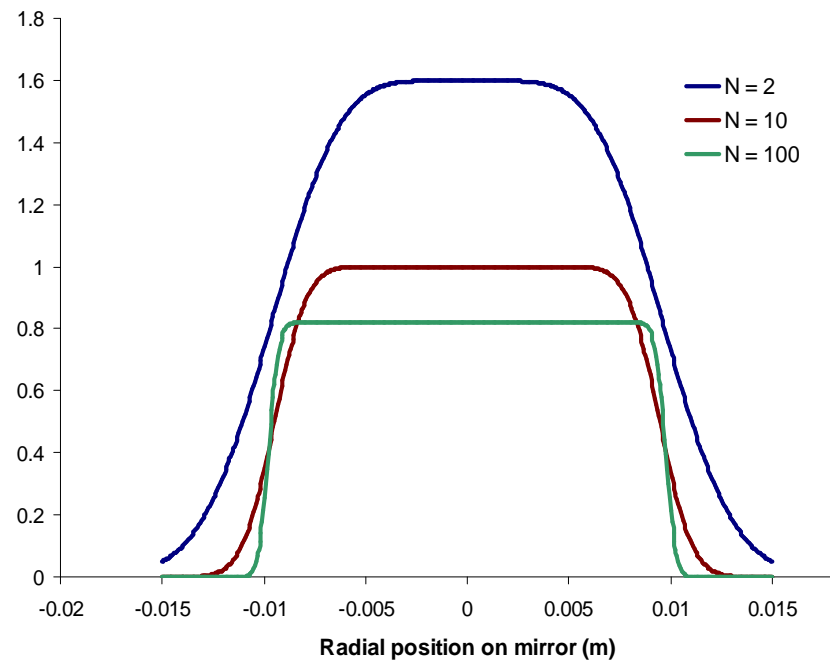

The Rayleigh range is inversely proportional to the order of the beam

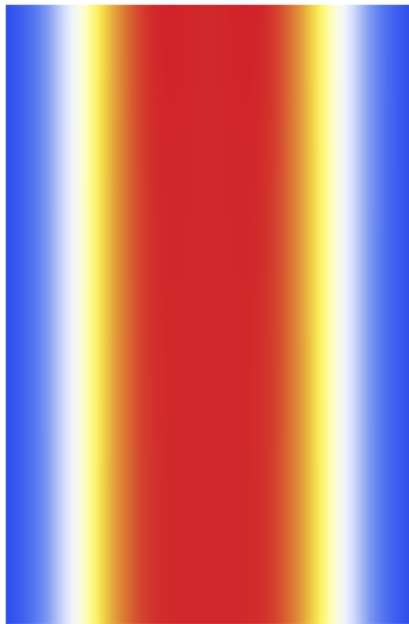

N = 2

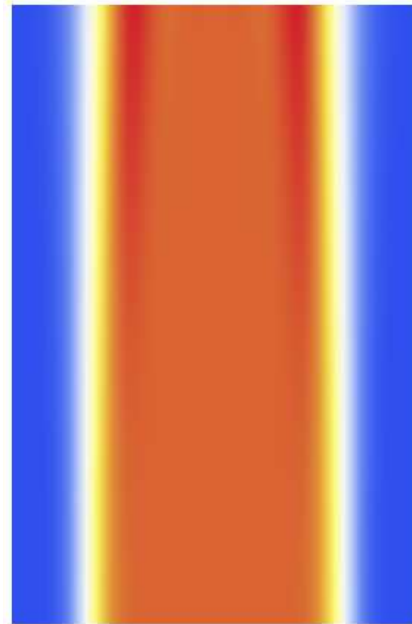

N = 10

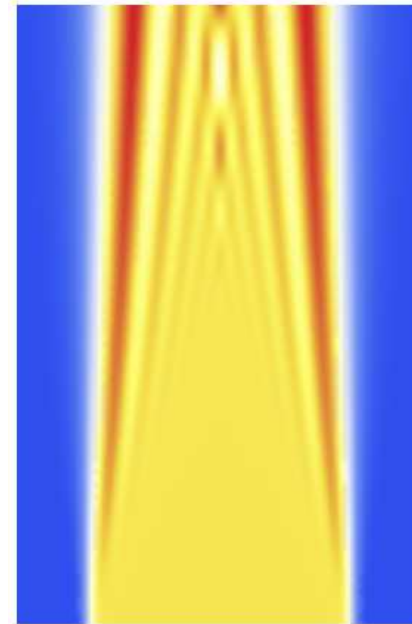

N = 100

Using a transmission DOE one can convert a Gaussian to flat-top intensity profile

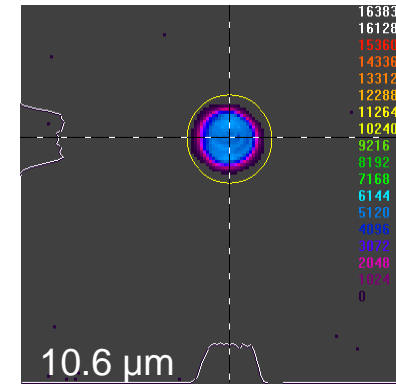
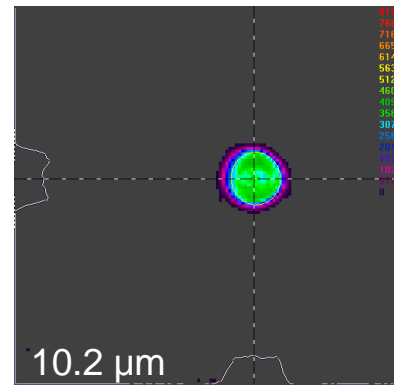
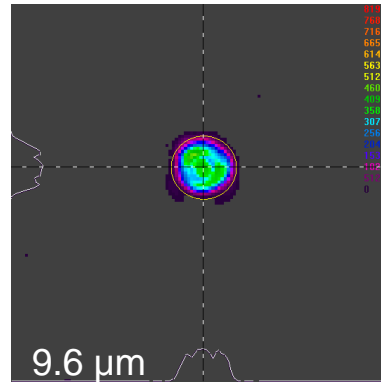
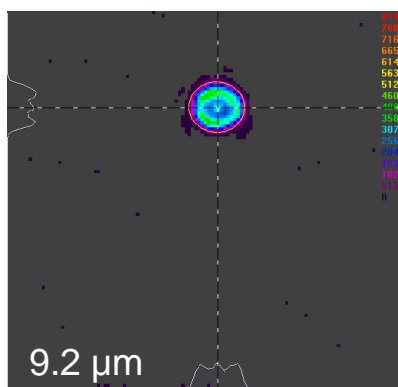
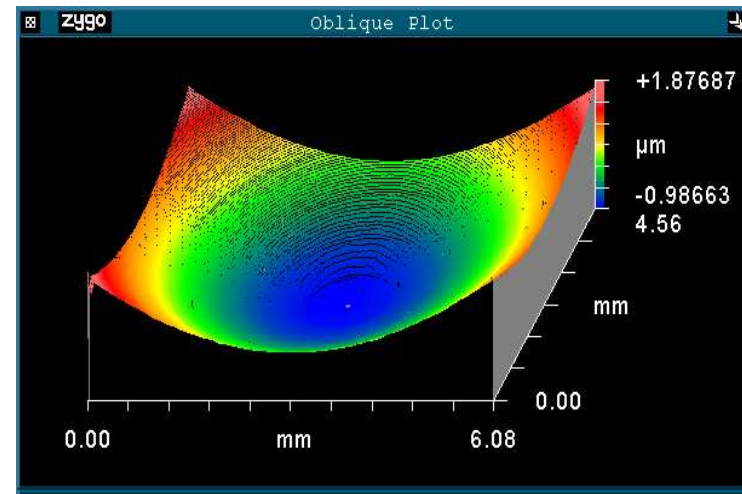
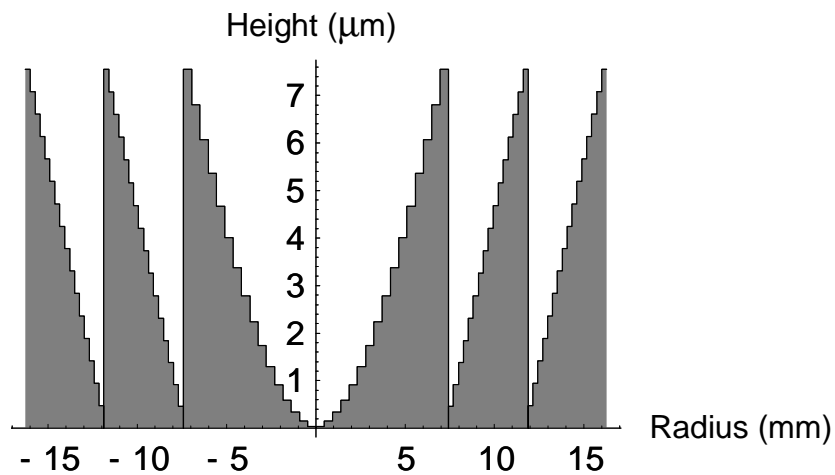

Modes may be selected by phase inside the optical resonator

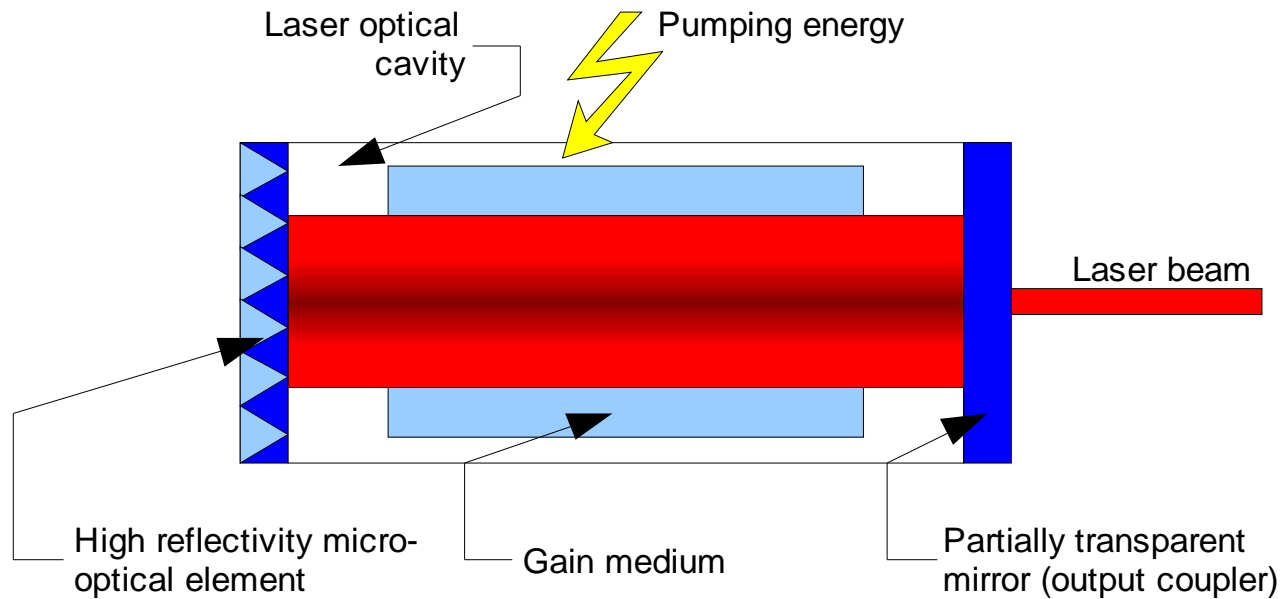

Design of a mirror to produce an N = 10 FGB

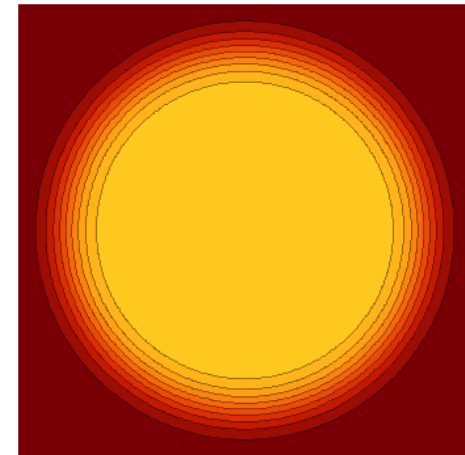
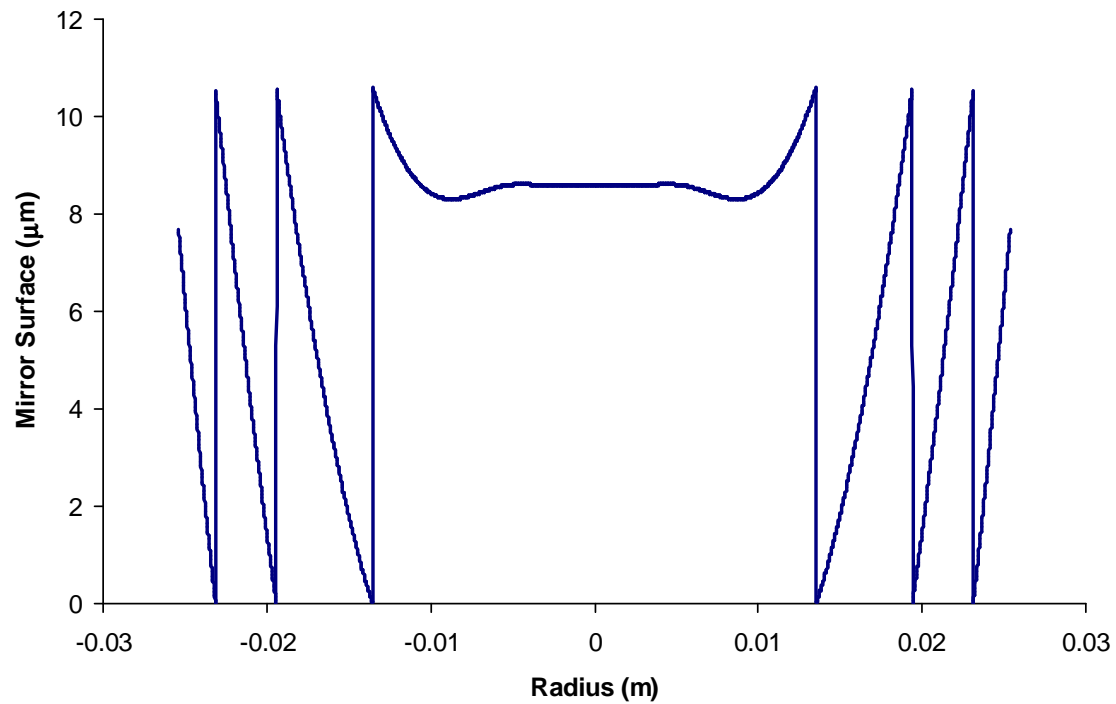

Fox-Li analysis

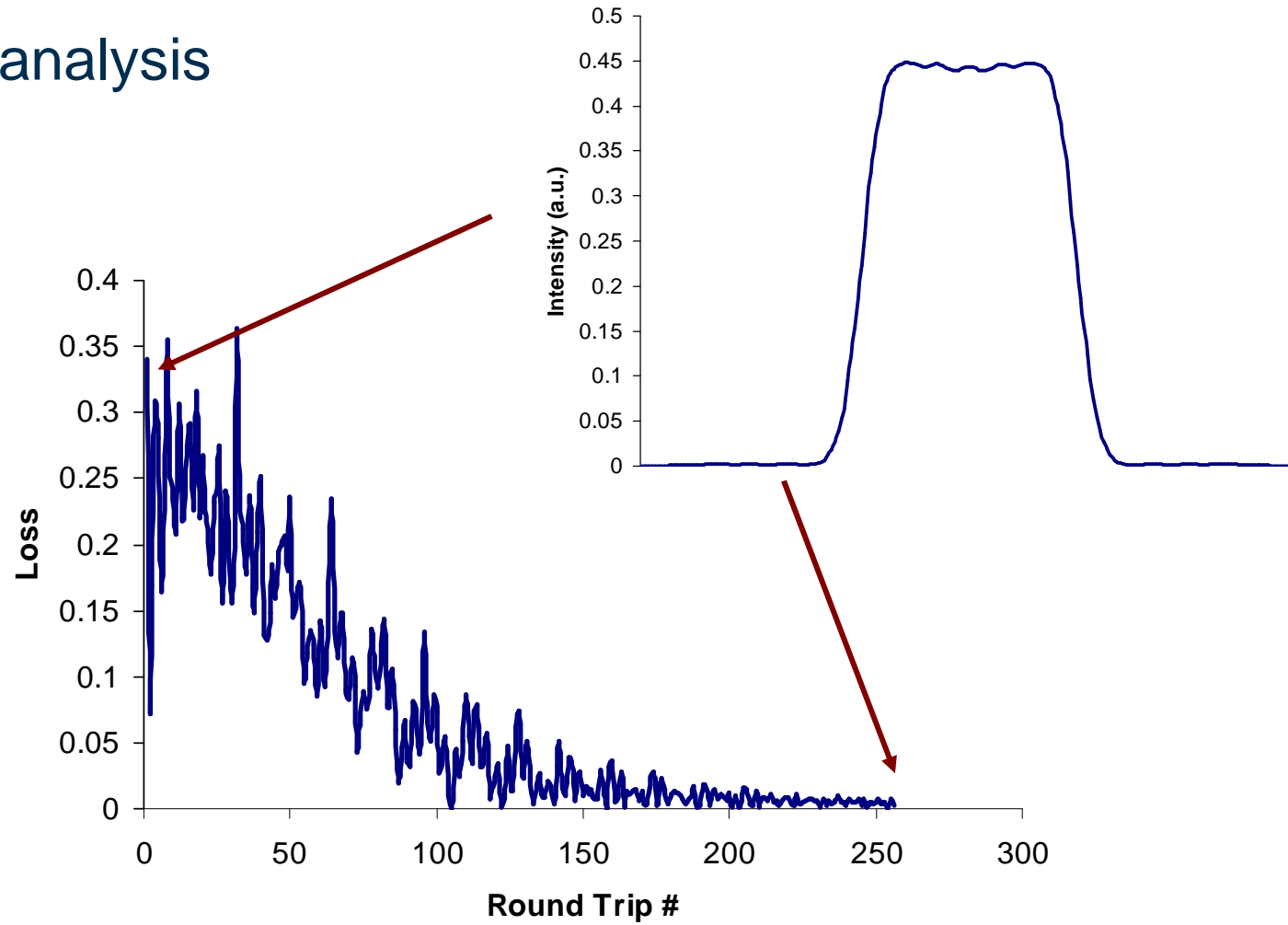

The mode competition is revealed in the loss convergence per round trip

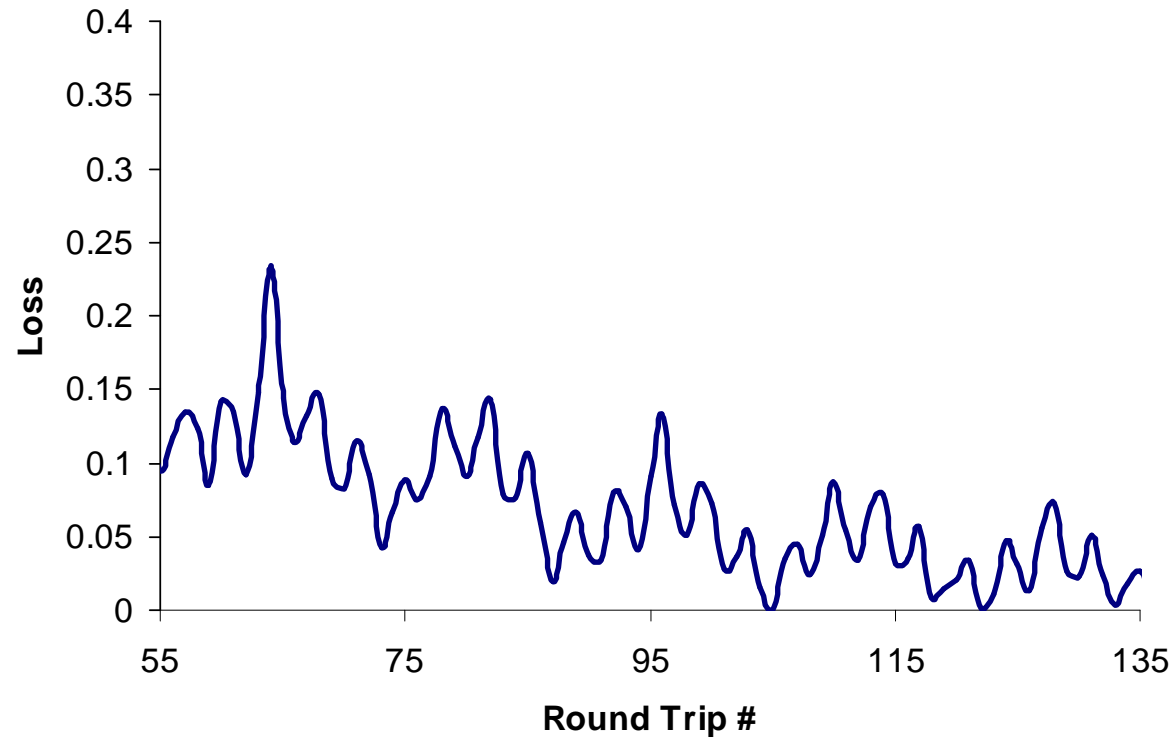

Piezoelectric unimorph mirror

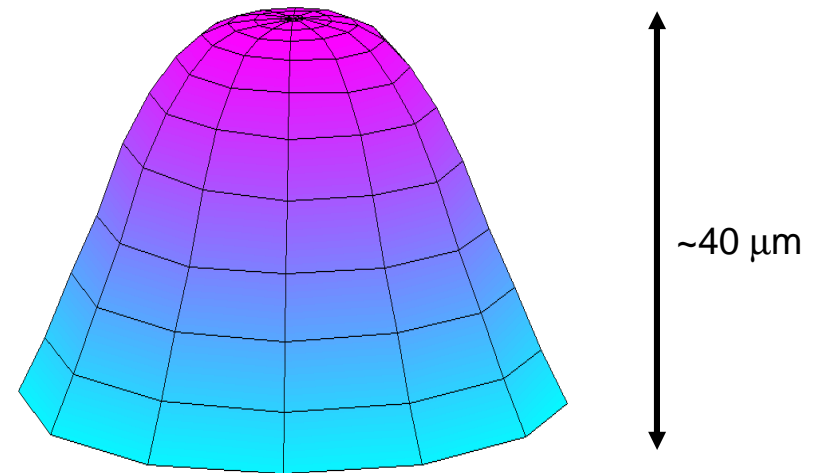
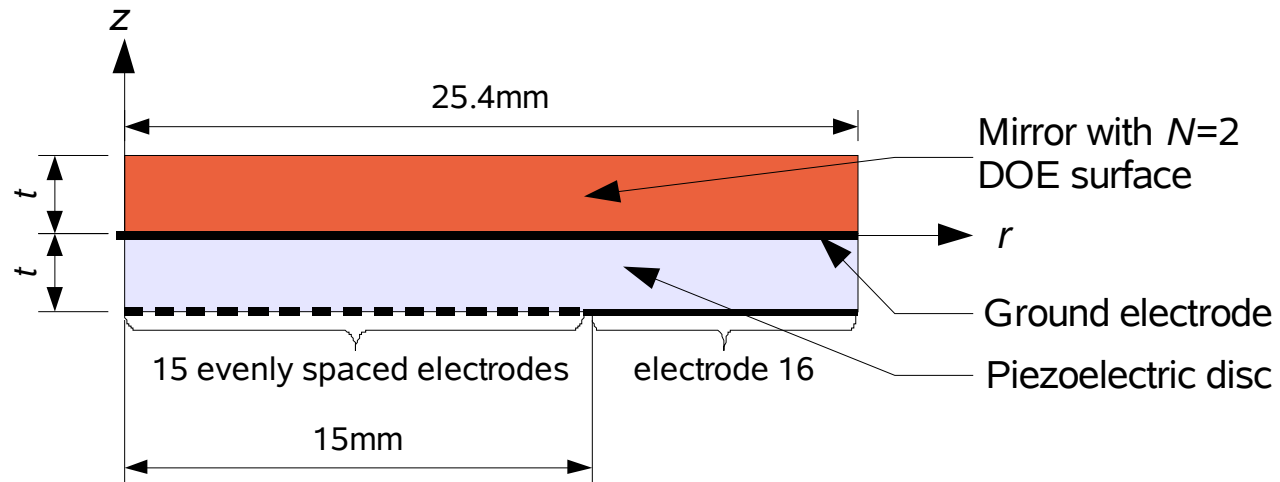

Combination of a DOE and adaptive mirror allows in-situ mode selection

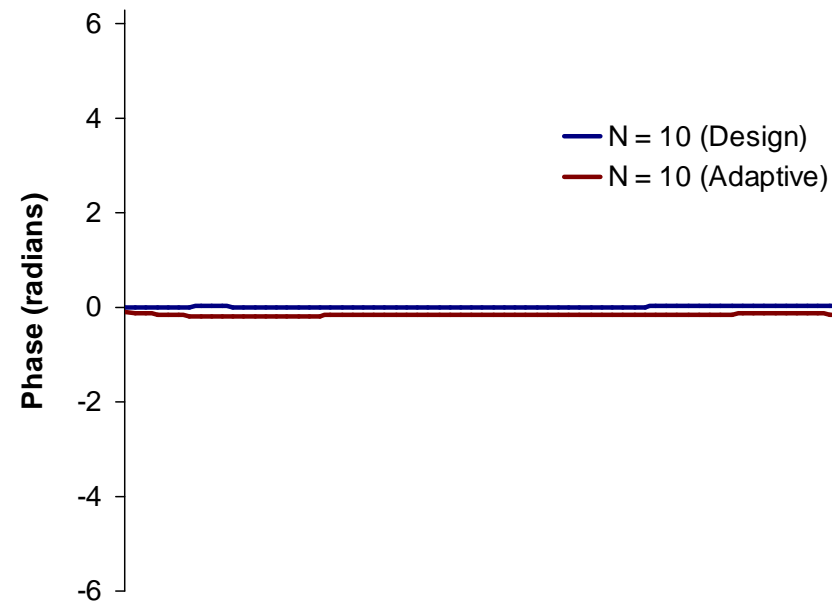

Industrial application



Laser based paint stripping



[movie](#)

TEA CO ₂ laser	
Pulse energy	5 J
Repetition rate	300 Hz
Average power	1.5 kW

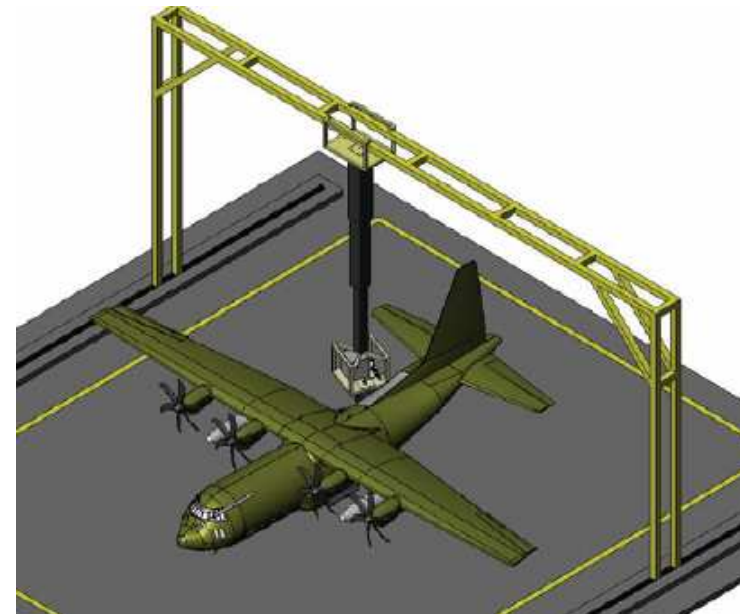

Single mode or multimode?

E~250 mJ, $M^2 \sim 1.1$

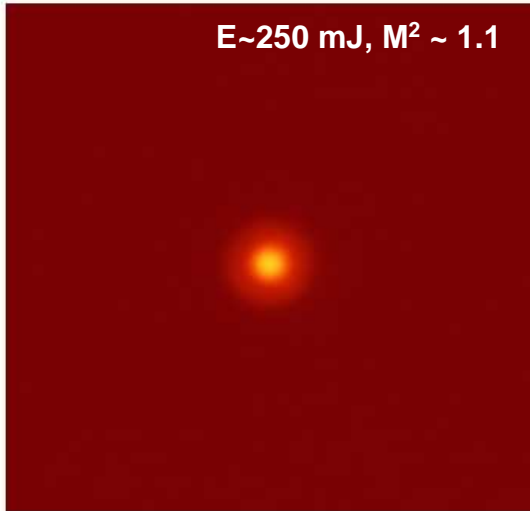

E~6.3 J, $M^2 \sim 25$

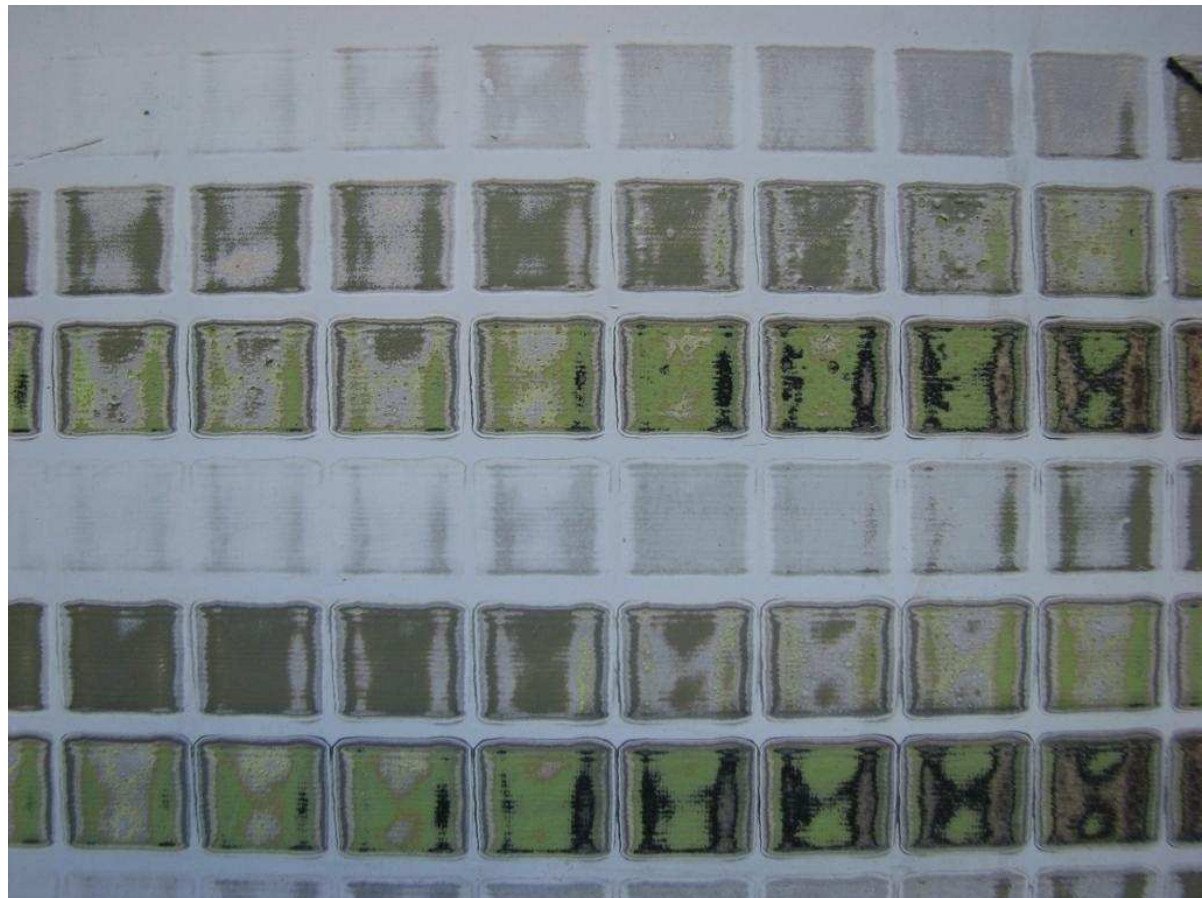
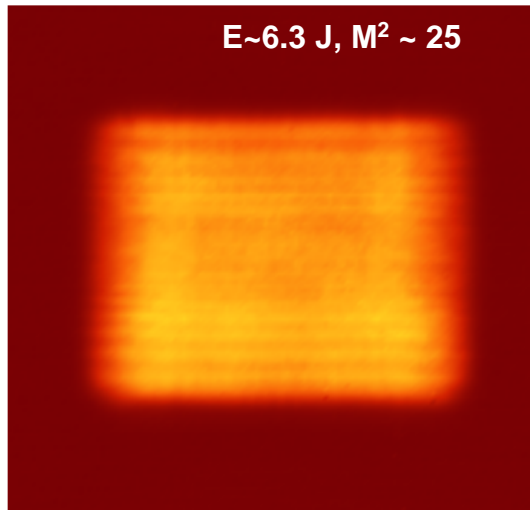

Design and fabrication of an intra-cavity DOE

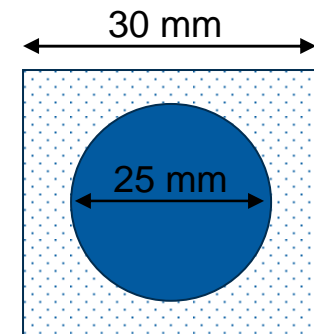
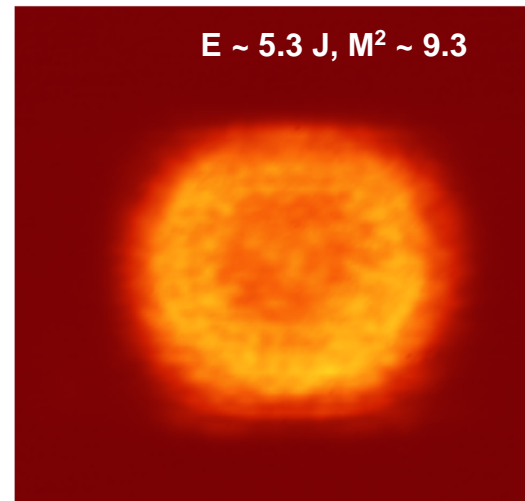
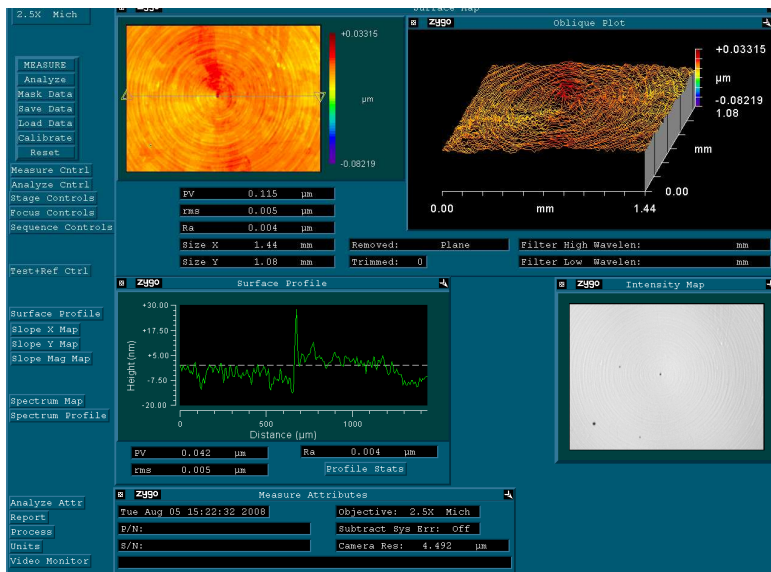
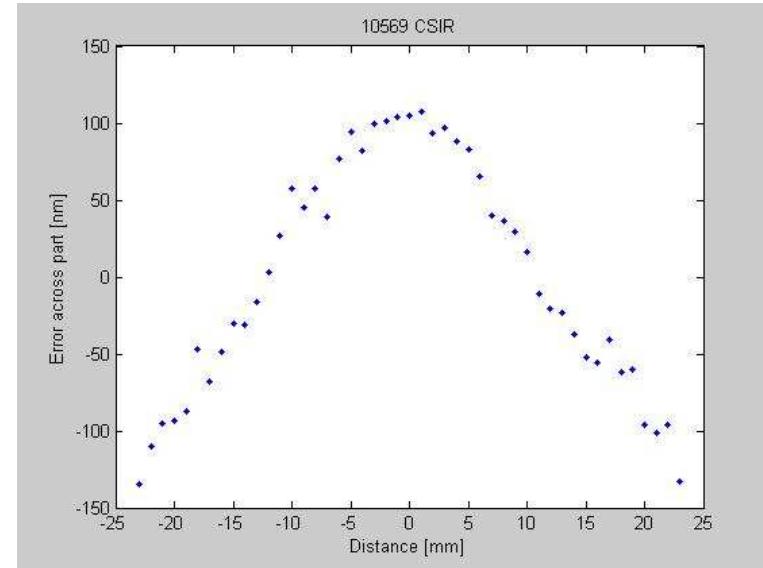
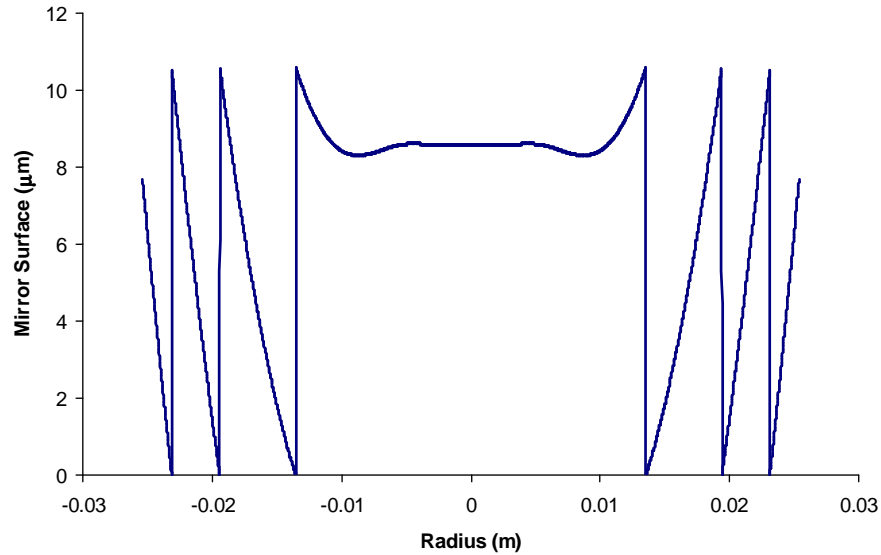

Paint stripping improvement

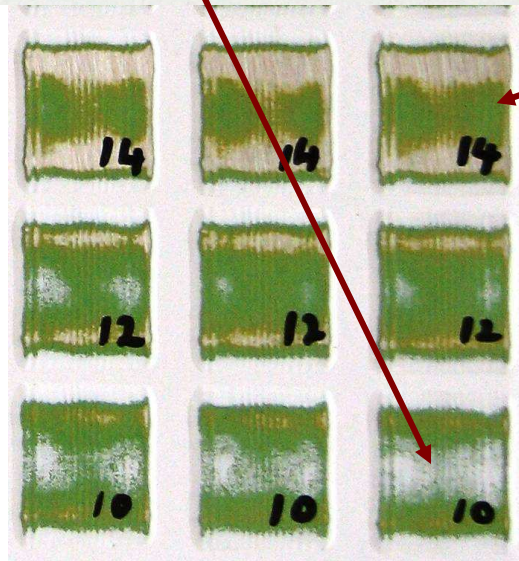
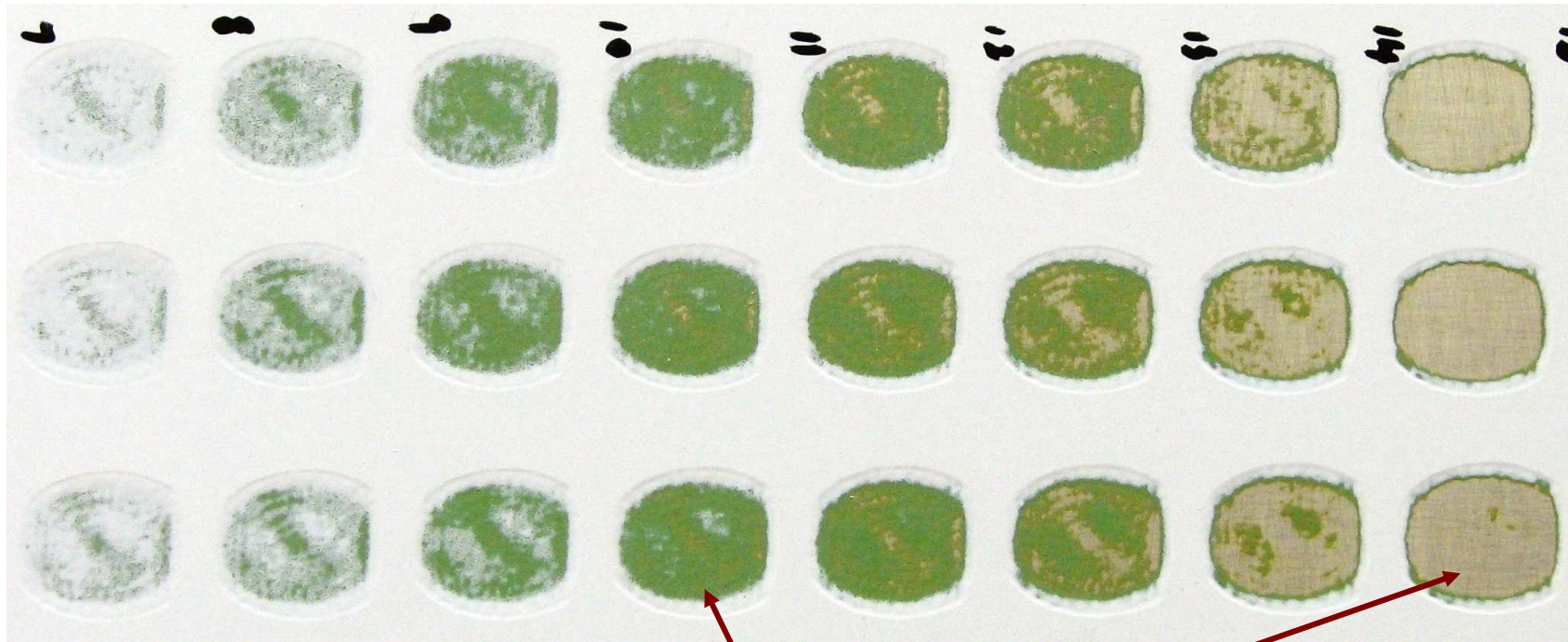

Thank You



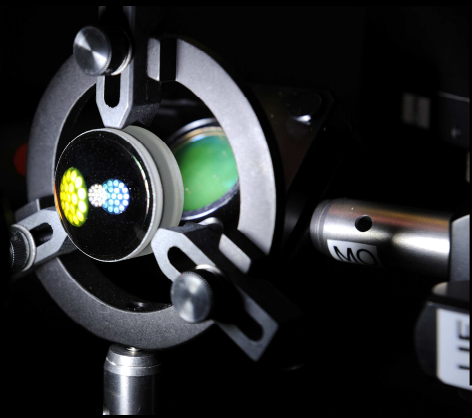

Join the Mathematical Optics research team!

**Opportunities: MSc and PhD studentships, Post docs and
Sabbaticals**

Contact: Dr Andrew Forbes or Dr Stef Roux

www.csir.co.za/lasers/index_mathematical_optics.html