

Safety in Mines Research Advisory Committee

Final Project Report

EFFECTIVE ROOF SUPPORT FOR TABULAR STOPES

**RW Ottermann
NDL Burger
AJ von Wielligh
MF Handley
GA Fourie**

**Research Agency
Project number
Date of report**

**RE@UP, University of Pretoria
GAP 813
September 2002**

EXECUTIVE SUMMARY

This project follows on from project GAP 708, *The Design and Development of an Effective Support System for Tabular Stopes in Gold and Platinum Mines*. The primary output of this project is to develop and surface test an effective roof support system and to do a risk assessment of the system. Mines with tabular ore bodies will use the roof support system to reduce fatalities and injuries in the face area of tabular stopes.

The roof support system consists of two similar support units connected to each other by two cranks. Each unit consists of a 210 x 1200 mm headboard supported by a “wishbone” structure (top and bottom leg) and a self-contained loading/yielding mechanism that keeps the legs apart. The yielding mechanism consists of a self-contained hydraulic cylinder, a pump to load and pre-stress the unit and a relief valve to accommodate slow yielding of the system. The system yields to both slow and sudden stope closure by a combination of elastic deformation in the wishbone structure and the pressure relief valve. Rapid yielding is mainly accommodated by the flexibility of the “wishbone” structure, and this also gives the system the necessary rebound, since stopes do not only undergo monotonic closure during a seismic event. The system is therefore more likely to stay in place, providing support resistance and energy absorption during the critical moments of the rockburst. The yielding mechanism is made from steel while the two legs of the “wishbone” and the headboard are manufactured from glass fibre.

To move the system forward one support unit is collapsed and then hangs from the other by the two cranks. The collapsed unit is then manually cranked forward and re-loaded. Each “step” forward is 300 mm, hence the system must be cranked forward three times to move 900mm (the typical face advance per blast in a tabular stope). Surface tests reveal that each collapse-crank forward-reload cycle takes 1 minute, requiring 3 minutes to move the system forward by 900 mm. Typically, twenty wishbone support units will be installed in a 30 m panel, and will take two persons one hour to move forward a distance of 900 mm. The support system can be tailored to meet specific mining parameters such as stoping width and average face advance per blast.

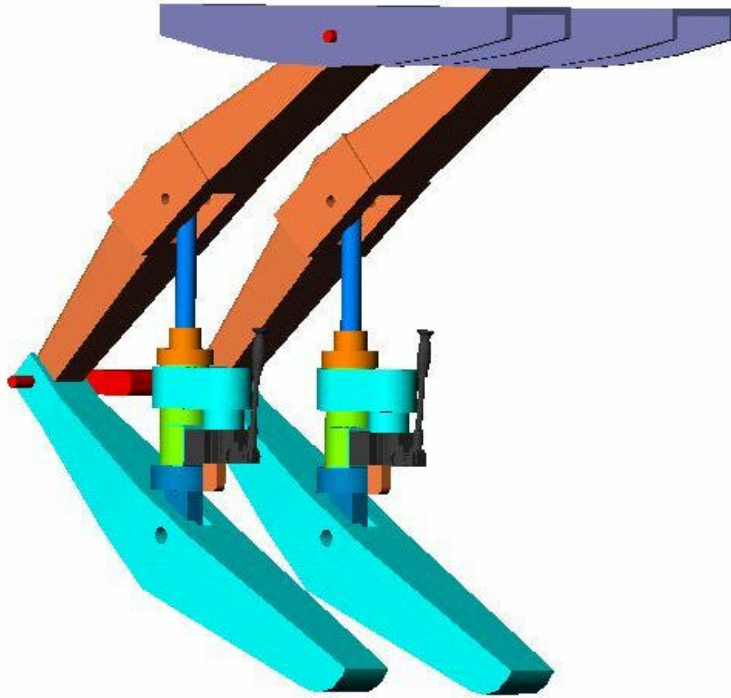

Figure of system

The system has undergone the typical engineering design and development process, beginning with a review of the design specifications, and a detailed evaluation of and modification to the concept that appeared in the GAP708 report. The prototype development process was an iterative process that involved detail design, building and testing of sub components and building and testing of the prototype. The testing of the prototype was done on surface in the laboratory and in a mock-up stope. A risk analysis, in which technical, logistical and economical aspects were assessed, was done to determine the critical areas of the system.

The tests and risk assessment of the roof support system identify certain areas that need to be addressed in order to implement the new support system safely underground. For the further development of the support system the areas that need attention are:

- Improve the design taking the results of the tests into account.
- Quality control during manufacture.
- Correct and safe installation procedures.
- Safe operating procedures.
- Develop a different support system, which can be cheaper and lighter for rock fall conditions.

During phase 2 of the project, working prototypes will be developed for underground evaluation.

ACKNOWLEDGEMENTS

The authors would like to express their gratitude to the Safety in Mines Research Advisory Committee (SIMRAC) for financial support of project GAP 813 and also for the interest and technical input of the SIMRAC Technical Committee. The team would also like to thank Duraset Mining Products, Grinaker-LTA (the industrial partner of the project) for their assistance in the project.

TABLE OF CONTENTS

Page

1	<u>INTRODUCTION</u>	2
2	<u>METHODOLOGY</u>	4
3	<u>REVIEW OF DESIGN SPECIFICATIONS</u>	5
3.1	<u>WEIGHT</u>	5
3.2	<u>STOPING WIDTH RANGE</u>	6
3.3	<u>LOADING ECCENTRICITY</u>	7
3.4	<u>MAXIMUM DIP AND STRIKE SPACING</u>	7
3.5	<u>MAXIMUM UNCOVERED HANGING WALL</u>	7
3.6	<u>STEP DISTANCE</u>	8
3.7	<u>STEP TIME</u>	8
3.8	<u>MAXIMUM DIP CHANGE RATE</u>	8
3.9	<u>MAXIMUM DIP OF STOPE</u>	8
3.10	<u>MINIMUM PRE-LOAD FORCE</u>	8
3.11	<u>SLOW YIELD RATE AND SLOW YIELD RESISTANCE</u>	9
3.12	<u>SLOW YIELD RANGE</u>	9
3.13	<u>RAPID YIELD CAPABILITY</u>	9
3.14	<u>FAST YIELD RANGE</u>	10
3.15	<u>MAXIMUM ALLOWABLE HANGING WALL AND FOOTWALL CONTACT STRESS</u>	10
4	<u>PROTOTYPE DEVELOPMENT</u>	11
4.1	<u>DETAIL EVALUATION AND MODIFICATION OF CONCEPT</u>	11
4.2	<u>DETAIL DESIGN</u>	14
4.2.1	<i>Structural components</i>	14
4.2.2	<i>Yielding mechanism</i>	17
4.2.3	<i>Walking mechanism</i>	18
4.3	<u>BUILD SUB-COMPONENTS</u>	19
4.3.1	<i>Structural components</i>	19
4.3.2	<i>Yielding mechanism</i>	20
4.3.3	<i>Walking mechanism</i>	21
4.4	<u>TEST SUB-COMPONENTS</u>	22
4.4.1	<i>Structural components</i>	22
4.4.2	<i>Yielding mechanism</i>	24
4.5	<u>BUILD PROTOTYPE</u>	25
5	<u>SURFACE TESTING</u>	27
5.1	<u>LABORATORY TESTS</u>	27
5.1.1	<i>Laboratory test rig</i>	27
5.1.2	<i>Laboratory tests</i>	28
5.2	<u>TESTS IN MOCK-UP STOPE</u>	29
5.2.1	<i>University of Pretoria mock-up stope</i>	29
5.2.2	<i>Kloof mine mock-up stope</i>	31

<u>6</u>	<u>RISK ASSESSMENT</u>	33
<u>7</u>	<u>CONCLUSION AND RECOMMENDATIONS</u>	36
<u>8</u>	<u>REFERENCES</u>	37
	<u>APPENDIX A: SUPPORT UNIT SPECIFICATIONS</u>	38
	<u>APPENDIX B: DESIGN OF COMPOSITE MATERIAL COMPONENTS</u>	41
	<u>APPENDIX C: REDESIGN OF COMPOSITE MATERIAL COMPONENTS</u>	42
	<u>APPENDIX D: DATAPAC OF ROOF SUPPORT SYSTEM</u>	43
	<u>APPENDIX E: DESIGN AND SPECIFICATION OF MOCK-UP STOPE</u>	44
	<u>APPENDIX F: DETAIL RISK ANALYSIS</u>	48

TABLE OF FIGURES

Page

Figure 4-1 Layout of “wishbone” roof support system as proposed in project GAP 708.	11
Figure 4-2 Forces in the yielding mechanism of “wishbone” roof support system as proposed in project GAP 708.	12
Figure 4-3 Layout of the roof support system	12
Figure 4-4 Forces in the yielding mechanism of the roof support system	13
Figure 4-5 Movement of system.	14
Figure 4-6 Geometry of roof support structure	15
Figure 4-7. Failure of top leg during testing.	16
Figure 4-8. Geometry of bottom leg near hinge showing the diagonal plate.	16
Figure 4-9: Yielding/preloading mechanism.	17
Figure 4-10: Layout of hydraulic cylinder.	18
Figure 4-11: Placement of cranks between roof support units to form walking beam.	19
Figure 4-12: Photo of top and bottom leg of wishbone and headboard.	20
Figure 4-13: Photo of assembled yielding mechanism.	21
Figure 4-14: Photo of connecting crank for parallelogram of walking mechanism.	21
Figure 4-15: Force/displacement characteristics of lower and upper leg.	23
Figure 4-16: Test set up of wishbone in servo hydraulic test facility.	23
Figure 4-17: Failure of top leg in hinge area.	24
Figure 4-18: Force displacement characteristics of the hydraulic yielding mechanism.	25
Figure 4-19: Photo of prototype roof support.	26
Figure 5-1: Laboratory test rig for dynamic load testing.	27
Figure 5-2: Photos of damaged top leg of wishbone.	28
Figure 5-3: Force/displacement characteristics of prototype 2.	29
Figure 5-4: Photo of roof support system in mock-up stope.	30
Figure 5-5: Use of lightweight concrete blocks to fill void above headboard in fallout.	31
Figure 5-6: Photo of roof support system in training mock-up stope of Kloof mine.	31
Table 6-1: Occurrence Probability Categories (equivalent to frequency)	33
Table 6-2: Consequence Severity Categories	33
Table 6-3: Risk Table	34

1 INTRODUCTION

Stope support systems have been consistently improved over the years, mainly through ongoing research and development by the support suppliers to the mining industry. There have been notable advances in the last decade, particularly with the introduction of yielding timber props, which have proven more effective and easier to manage as a generic rockburst resistant support at the stope face than the rapid yielding hydraulic prop systems used previously. The yielding props have been so successful that they have virtually replaced rapid yielding hydraulic props at the stope face. This success comes at a price: the yielding timber props might be more effective, but they are more costly to use than the equivalent rapid yielding hydraulic prop system because they are not recoverable after installation, being eventually destroyed by stope convergence in the back areas. Despite many attempts at improvement, both the rapid yielding hydraulic prop and yielding timber prop systems still suffer from an inability to provide effective a real support of the hangingwall at the stope face, and in the immediate working area behind.

During the late 1990's, it became apparent that areal support was critically important for hangingwall stability during a rockburst, and studies to determine the effect of prop supports on the hangingwall were financed by SIMRAC (e.g. Daehnke et al., 1999, Daehnke et al., 1998). This and the above-mentioned factors led the University of Pretoria team to set global specifications for the support system to include the following:

- Each unit must provide good areal support;
- The support units must be re-usable (i.e. they must be able to move forward as the face advances);
- The unit must provide protection to the operator whilst it is being moved forward;
- The unit must provide adequate rapid yield and slow yield capabilities;
- The unit must be reliable, easy to install, easy to move forward, and easy to maintain.

The above specifications were formulated in addition to those agreed to by all parties involved in SIMRAC Project GAP708 (Daehnke et al., 2000). An additional goal of the project was that both the University of Pretoria and the CSIR Division of Mining Technology teams develop design concepts that would meet all the specifications given in GAP708. The design concepts were presented to the platinum and gold mining industries at two separate workshops on Tuesday and Wednesday 12th and 13th December 2000 respectively. Consensus from the two workshops indicated that the "Wishbone System" from the University of Pretoria and the "Remotely Advanced Stope Support System" (RASS) of

the CSIR Division of Mining Technology would receive further support from SIMRAC. Both systems were to be developed concurrently, but independently, to the prototype stage. GAP708 therefore served as a springboard for the new research and development phase. This is the final report on project GAP 813, which covers phase 1 of the design and development of the “Wishbone” support unit.

2 METHODOLOGY

The following methodology was followed during this project:

- The design specifications for the roof support system were reviewed.
- The concept as developed in project GAP 708 was evaluated in detail after which the concept was modified and finalised.
- The prototype development process was an iterative process that involved the following steps:
 - Detail design of system layout
 - Detail design of components.
 - Building of components.
 - Testing of components.
 - Integration of system.
 - Testing of prototype.
- The testing of the prototype was done on surface in the laboratory and in a mock-up stope. A specially designed and built mock-up stope was used.
- To determine the critical areas of the system a risk assessment was done. Technical, logistical and economical aspects were assessed.
- A video was made showing the operation and handling of the support system as well as some tests.

3 REVIEW OF DESIGN SPECIFICATIONS

Project GAP 708 defined the specifications for a new stope face support system for tabular hard rock mines, and provided conceptual designs, which have been carried over into the current project, GAP 813. The objective of the current project is to design and develop a workable stope face support system, and bring it to the prototype testing stage. The specifications provided in GAP 708 are general in that they do not apply to individual units. Now that a conceptual design has been completed under GAP 708, it is appropriate to provide a *design specification* for the detail design. The general specifications need to be re-expressed per support unit, so that the proper objectives are set for the design process.

The design specifications were finalised by the team at a meeting on Tuesday, 22nd May 2001, and appear in Appendix A. They contain both quantitative and some of the qualitative information that appeared in the original design specifications prepared during project GAP 708 in 2000. Some of the qualitative data, such as “safe to operate”, “ease of assembly”, etc. are omitted, but not ignored. The quantitative specifications are based on the work of Roberts (2000), modified by Roberts et al. (2000). The qualitative specifications are self explanatory, and more difficult to evaluate. Therefore, they will not be discussed any further in this report, but will be covered in design reviews, where the ability of the units design to meet them is evaluated at different intervals during the design process. Each quantitative specification will be discussed in detail below to clarify the result that is presented in Appendix A.

The specifications based on those of Roberts et al. (2000) have been restated in order to clarify the design goals of an individual support unit. They have been called *design specifications* to avoid any confusion with the rock engineering specifications provided by Roberts et al. (2000) in SIMRAC Project GAP708.

3.1 Weight

The weight of each component is specified as 30 kg or less. A component is defined for example as a leg, the loading and release mechanism, or the headboard. The assembled support unit will weigh the sum of its component weights, and will thus be much heavier than 30 kg. However, the design of the unit will be such that stope personnel will never have to work with the entire unsupported weight of the unit, as it will be constructed in pairs, and when one unit is being moved forward, the second paired unit will support the first unit's weight.

The restriction of 30 kg per component applies firstly to allow the designer flexibility in choice of materials and component design in the early stages, and secondly for transport and assembly in the stope. It is planned that the units be transported as separate components because they will occupy much less space, and then assembled in the stope. This approach holds the advantage that the units will be modular, and damaged components can be replaced at the stope face whenever necessary without compromising safety or the integrity of the support system. The second advantage is that stope crews will never have to manhandle any component or subsystem that weighs more than 30 kg.

3.2 Stopping width range

Roberts et al. (2000) state that stope support systems have to operate at a variety of mining heights, typically between 0.9 and 2.5 metres. This covers the vast majority of stopping widths encountered in tabular hard rock mines in South Africa, and has been accepted by the team as the range of stopping widths in which the support system must be able to work.

Because of the articulating design of the proposed unit, there is a practical restriction imposed by the weight of the individual components. If the support unit is designed to accommodate a stopping width of 2.5 metres, the length of its legs will have to be at least 1.4 metres long, which means they will need to be thicker and heavier to withstand the bending moments that will develop during rapid yield. Furthermore, when such a prop is installed in a narrow stope, 0.9 metres high, it will occupy a strike length of 1.32 m excluding the headboard. This could pose severe restrictions upon the mobility of people between the support units in the stope.

The team therefore decided on 22nd May 2001 to design a support unit that could be installed in stopping heights ranging from 1.1 to 1.5 metres, and then a second, scaled-up unit that could handle stopping widths ranging from 1.5 to 2.5 metres. The latter unit would only be designed once the former one had been tested and proven. The team also discussed the possibility that the smaller unit might be able to handle all stopping widths, by attaching it to columnar foot pieces either 0.7 or 1.0 m long, which would then extend the range of the support unit to 1.8 to 2.2 m and 2.1 to 2.5 m respectively. At this stage, it is too early to fix the height ranges the unit must cover, and for the time being, a unit design sized to handle stopping widths from 1.1 to 1.5 metres will be designed and tested.

3.3 Loading eccentricity

Support units are seldom loaded along their intended loading directions in an underground environment (for example the intended loading direction of a column is along the column centreline), because of non-parallel footwall and hangingwall profiles, broken rock on the footwall, or eccentric installation of the unit by the support crew. Roberts et al. (2000) do not specify a maximum eccentric load misalignment, but for the purposes of these specifications, the team has accepted the specification set by the University of Pretoria investigation team in GAP 708. This was stated to be a maximum level of misalignment of $\pm 20^\circ$. The effects of misalignment will be investigated analytically during the planned design and design review process.

3.4 Maximum dip and strike spacing

The units should be able to provide rock engineers with flexibility in their stope support designs. Therefore, the design team has provisionally agreed upon a maximum dip and strike spacing between support units of 2.0 metres. This means that each pair of support units should be able to provide sufficient support resistance and energy absorption for a maximum hanging wall area of 4m^2 (see below for energy absorption and support resistance requirements).

3.5 Maximum uncovered hanging wall

Recent research on the influence of mining induced fractures and support interactions in the hanging wall has indicated that the maximum strike distance of unsupported hanging wall (between support units or areal support units) should not exceed 0.75 metres for breast panels aligned on dip (Roberts et al., 2000). In the same circumstances, the dip distance should not exceed the strike span by a factor of 1.5. For up dip and down dip mining panels, the dip and strike distances should be interchanged because of the prevailing face-parallel mining-induced fracture directions. The above specification has been rounded down slightly to enable expression of both specifications to the nearest 0.1 metres, i.e. 0.7 and 1.2 metres respectively.

This specification will determine the headboard size required for the unit. If the size is such that the required headboard becomes excessively heavy, the maximum allowable distance between support units may have to be revised downwards to allow a reduction in headboard size. This aspect will be reconsidered during the planned design reviews and during the testing phase of the support unit.

3.6 Step distance

The step distance is the distance a row of units can be moved forward in one step. At this stage, there is no intention to make the step distance adjustable, but the design may allow different customers to specify step distances to suit the average face advance per blast on their mines. For the purposes of this design the step distance has been set at 0.30 m, but this will be reviewed during the design review and during the testing phase of the support units.

3.7 Step time

In the absence of any information on the support unit, the step time, defined as the time needed for one person to unload a unit, move it forward and reload it in the new position, has been arbitrarily set at two minutes. This means that a row of 20 supports with a dip spacing of 1.5 metres in a 30-metre panel would take approximately 40 minutes to move forward. The step time will be reviewed during design review and in the underground testing phase.

3.8 Maximum dip change rate

Roberts et al. (2000) specify that a support system should be able to accommodate changes in dip of 15° over a 5 metre section, which translates to 3 degrees/meter as listed in the specifications in Appendix A.

3.9 Maximum dip of stope

Roberts et al. (2000) state that the “great majority” of gold and platinum ore bodies dip at less than 30° . The team accepted that this might be true but prefer to set a steeper dip limit because it will be possible to use the unit in steeply dipping stopes. The maximum dip limit at this stage has been arbitrarily set at 45° , and this limit will be revisited in the design review and underground trials.

3.10 Minimum pre-load force

The units should permit routine preloading upon installation of at least the minimum support resistance loading required. Since the supports may be spaced a maximum distance of 2.0 by 2.0 metres apart (see Section 3.4 above), and the minimum support resistance requirement is

40 kN/m² (Roberts et al., 2000), a unit should be preloaded to a minimum of 100 kN.

3.11 Slow yield rate and slow yield resistance

Based on the specifications of Roberts et al. (2000) and the maximum allowable support distance of 2.0 by 2.0 metres (see Section 3.4 above), the units must be able to sustain a daily closure rate of 30mm/day, while providing a minimum support resistance of 100 kN per unit.

3.12 Slow yield range

The support unit must be able to sustain slow yield over its entire yielding range in a stable manner. Roberts et al. (2000) specify a total closure of 350 mm, of which 200 mm is dynamic closure and the remaining 150 mm slow closure. The unit must be able to sustain the slow closure at any point of its range; therefore, it must be able to sustain it over the entire 350 mm closure.

Because the support unit may have changing slow yield capacity that depends upon the changing geometry of the unit, the 350 mm closure capacity has been specified for the most difficult circumstances, i.e. in a 0.9 metre stope. That means that the support system must be able to sustain slow closure at 30 mm/day in a stope just 0.9 metres high, therefore meaning that the units should still be able to provide acceptable support resistance in a stope a minimum of 0.55 metres high. It should be able to provide similar performance at its maximum extension, i.e. in a stope initially 1.5 m high.

3.13 Rapid yield capability

After Roberts et al. (2000), the support unit should be able to rapid yield in a stable manner at 3 m/s. They specify energy absorption of 40 kJ/m². This translates to a block of maximum dimensions 2.0 x 2.0 x 2.3 m high if the density is assumed as 2700 kg/m³, and 2.0 x 2.0 x 2.1 m high if the density is 3000 kg/m³. The force required to stop a block of 2.0 x 2.0 x 2.3 m high in a distance of 0.2 metres is calculated as follows.

The mass of the maximum allowable block (assuming a density of 2700 kg/m³) = 2700 x 2 x 2 x 2.3 = 24840 kg. The acceleration required to stop the block moving at 3 m/s in 0.2 m is given by $v = 2a(x - x_0) + v_0^2$, and substituting the required velocities and distances specified by Roberts et al. (2000), $0 = 2a(0.2) + 3^2$ yielding an acceleration of 22.5 m/s². To this must be added the acceleration due to gravity, since the block is assumed to be moving vertically downwards, therefore $a = 32.31$

m/s^2 . By Newton, $F = ma$, hence the resistance force required $F = 24840 \times 32.31 = 802\,580 \text{ N}$.

This translates to a rapid yield support resistance of 200 kN/m^2 , or 400 kN per support unit. This requirement may be too onerous for current material technology and the present conceptual design. In order to make it possible for the unit to deliver such performance without being too heavy, it may be necessary to reduce the maximum allowable dip and strike spacing specified in Section 3.4.

3.14 Fast yield range

Like the slow yield, the unit should be able to sustain fast yield at any point in its closure range, hence it should be able to provide stable fast yield over the entire 0.35 meter closure in a 0.9 m high stope. This performance must not be influenced by the degree to which the unit is opened; hence, it should be able to deliver the same performance at the other extreme of its range, i.e. in a 1.5 m high stope. This requirement may be too onerous for current material technology and the present conceptual design. Therefore, in order to make it possible for the unit to deliver such performance without being too heavy, it may be necessary to reduce the maximum allowable dip and strike spacing specified in Section 3.4.

3.15 Maximum allowable hanging wall and footwall contact stress

Roberts et al. (2000) specify a maximum contact stress of 30 MPa , which translates to a minimum sized headboard and foot of $0.1 \times 0.1 \text{ m}$. This result is obtained by assuming the maximum resistance force developed per unit occurs during rapid yield, and that this force is 400 kN/unit . This specification thus specifies a minimum-sized headboard and footboard. Other requirements, such as those in Sections 3.4 and 3.5 (maximum allowable support spacing and maximum allowable unsupported hanging wall distances) will require larger headboards than the minimum size specified here.

4 PROTOTYPE DEVELOPMENT

The prototype development process was an iterative process. The different components were designed in detail, built, tested, redesigned, built and tested again. After the successful evaluation of the sub-systems the system was integrated and tested.

4.1 Detail evaluation and modification of concept

A computer model of the “wishbone” roof support system concept as proposed in project GAP 708, see figure 4-1, was built. The simulation of the system showed excessive forces in the yielding mechanism during the latter part of yielding. Figure 4-2 shows the forces in the yielding mechanism.

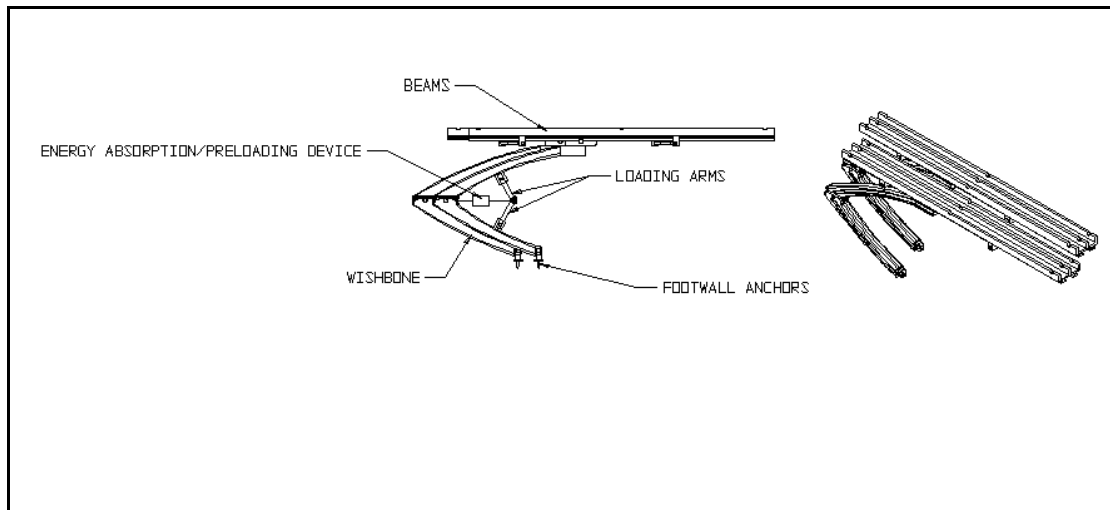

Figure 4-1 Layout of “wishbone” roof support system as proposed in project GAP 708.

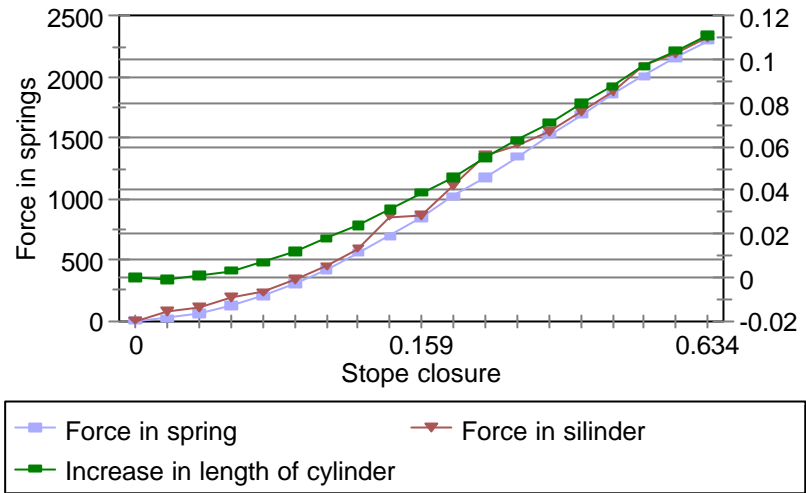

Figure 4-2 Forces in the yielding mechanism of “wishbone” roof support system as proposed in project GAP 708.

To accommodate the forces in the system the layout of the system was changed. The yielding cylinder is placed vertically between the two legs of the wishbone and the rapid yielding is accommodated in the deflection of the wishbone structure. The legs of the wishbone give the required deflection and act as springs as well as structural members. In figure 4-3 the layout of the revised roof support system is shown and in figure 4-4 the forces acting in the yielding mechanism are indicated.

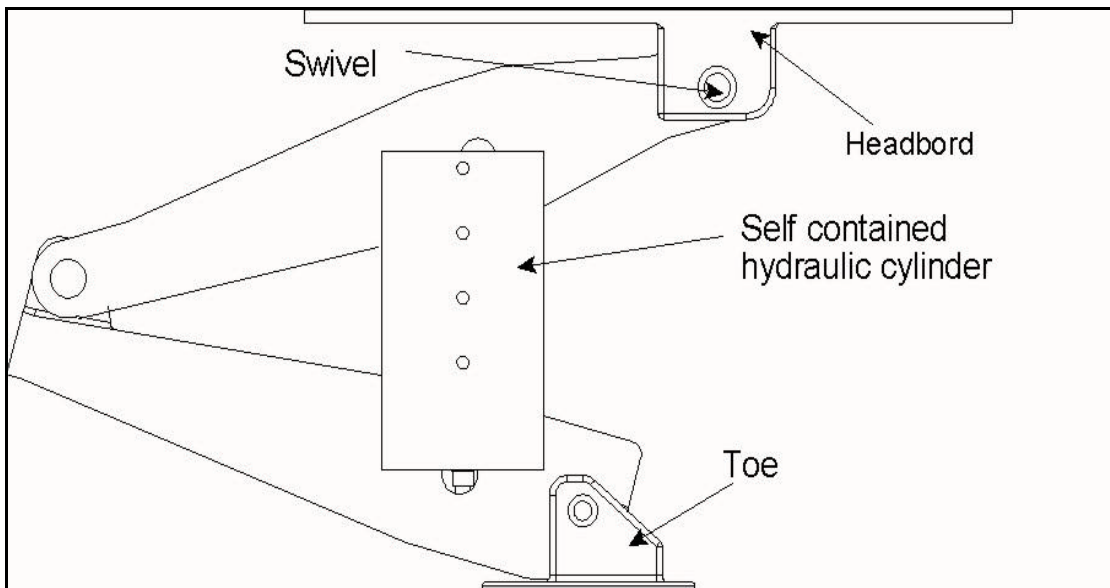

Figure 4-3 Layout of the roof support system

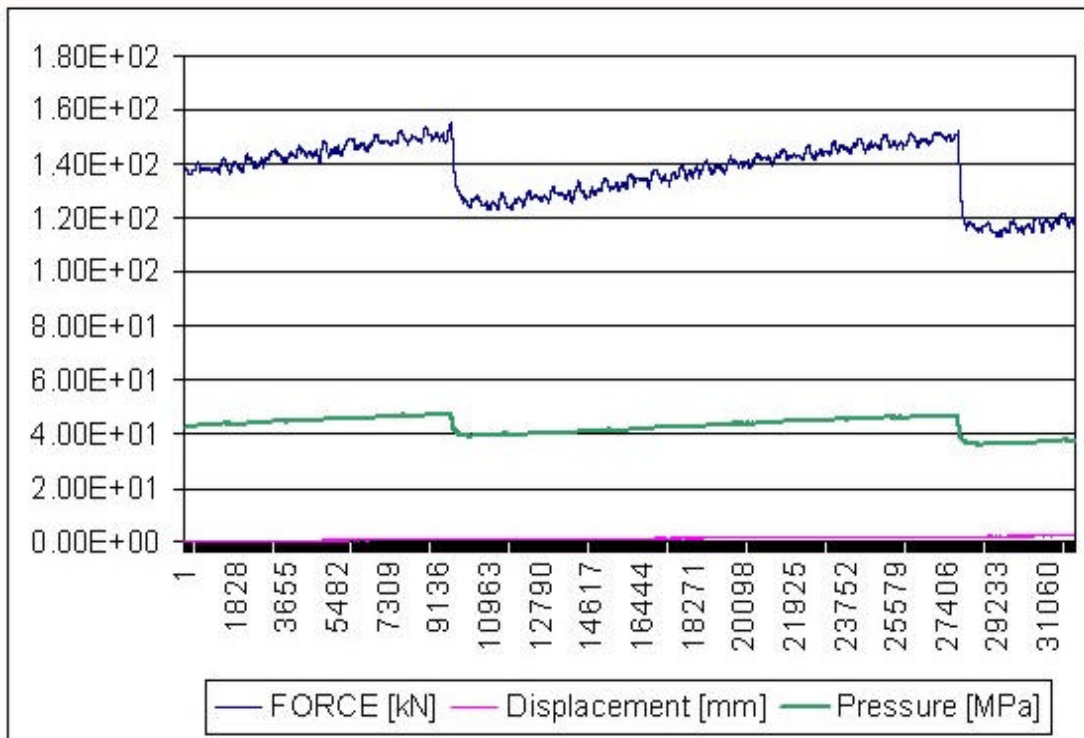

Figure 4-4 Forces in the yielding mechanism of the roof support system

The system consists of a wishbone type construction fitted with a headboard (beam) that supports the roof. The wishbone support can extend or collapse to accommodate different stopping heights. The wishbone has different length legs, with the bottom one being shorter so that it is further away from the rock face and thus leaves more working area for example, the scraper. A yielding device is used to pre-load the system and yield when closure of the stope takes place. Any rapid yielding is accommodated in the elasticity of the wishbone legs and a limited amount in the loading device. The two adjacent beams are connected via a parallelogram to create a walking beam. During forward movement the one system is collapsed and hangs from the other, which makes the forward movement of the support unit easier. The legs are pulled together by coil springs and the system is manually cranked forward. In figure 4-5 different steps of the movement of the system are illustrated.

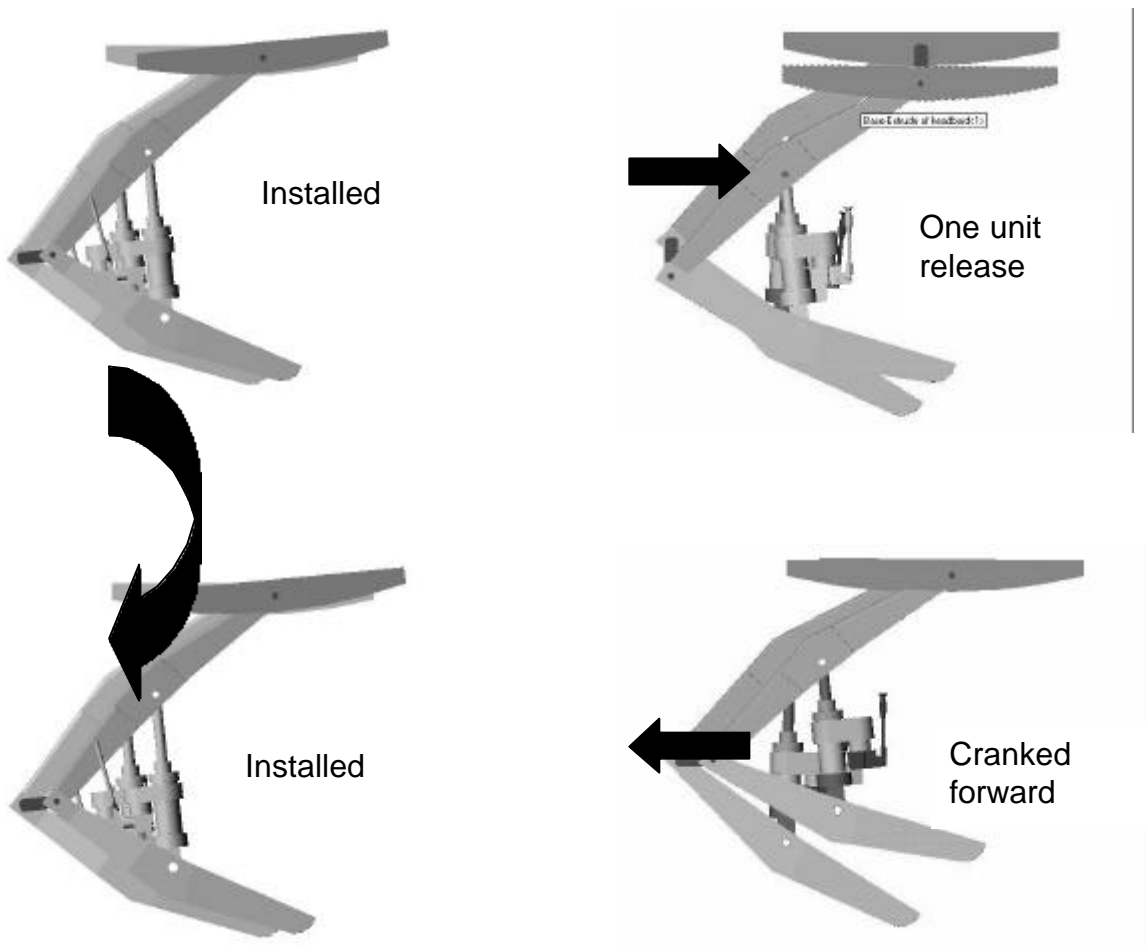

Figure 4-5 Movement of system

4.2 Detail design

The design of the different components and sub-systems is discussed as per sub-system.

4.2.1 Structural components

4.2.1.1 Design

MMS Technology CC, who specialise in composite materials, did the design and development of the structural components of the system, the headboard and the wishbone structure. The structural components of the system are the top and bottom leg of the wishbone and the

headboard. In figure 4-6 the geometry of the roof support structure is shown.

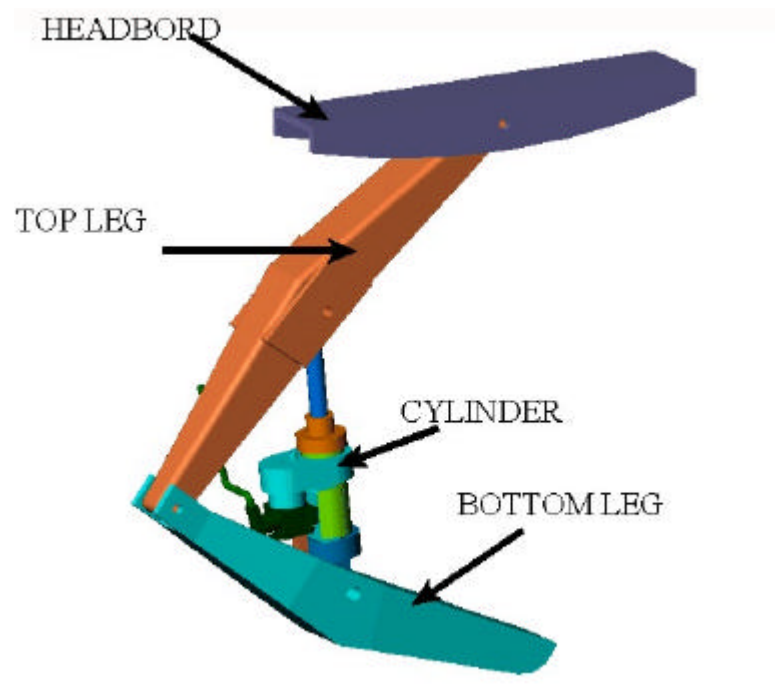

Figure 4-6 Geometry of roof support structure

The finite element analysis package, Ansys, was used to design the components. An overall safety factor of 1.5 was used for the design. The design of the composite structure with finite element plots is discussed in detail in Appendix B.

4.2.2.2 Redesign

During the testing of the structural components the headboard passed the tests and the top and lower legs of the wishbone failed at a load of approximately 12 tons. The main cause of failure was the fibre orientation in certain areas. The fibres did not have sufficient coverage in all directions. Figure 4-7 shows the failure on the top leg. Very few fibres were present through the crack. Most of the fibres in this area run along the length of the beam, with only a small percentage of fibres around the beam, which would have held the beam together. This failure occurred on the top leg near the pin joining it with the bottom leg.



Figure 4-7. Failure of top leg during testing.

The second problem was that the geometry in the failure area was inherently weak. Various options were analysed, but the only feasible solution without the component becoming too bulky, was to stiffen the area through the use of a diagonal plate between the two arms. This allows the stresses to be distributed from the compressive side to the tension side. Figure 4-8 shows a drawing of the layout. With this geometry, the continuity of the glass fibres is critical. The fibres need to have good continuity from the top surface to the lower surface and from the one side to the other side.

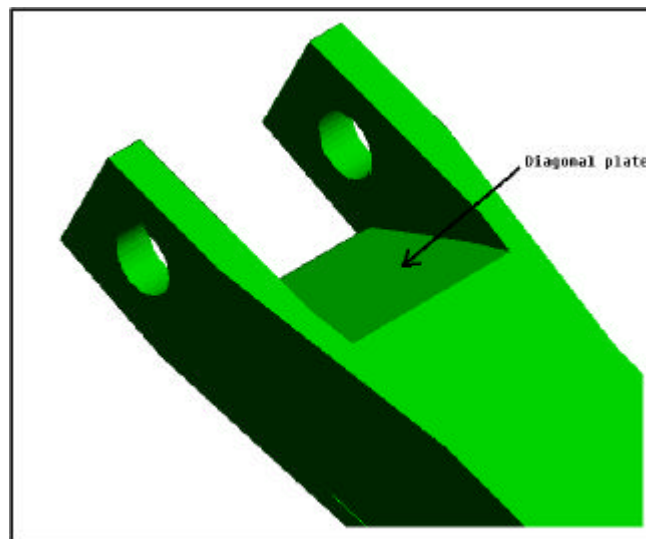

Figure 4-8. Geometry of bottom leg near hinge showing the diagonal plate.

The redesign of the composite structure with finite element plots is discussed in detail in Appendix C and the detail drawings of these components are attached in Appendix D.

4.2.2 Yielding mechanism

The yielding and pre-setting mechanism consists of a self-contained hydraulic cylinder, a reservoir, a release valve and a hydraulic pump. The mechanism is placed between the top and bottom legs of the wishbone and is used to preset the system and to yield at 10 tons. The yielding mechanism is connected to the top and bottom legs of the wishbone via hinge pins. In figure 4-9 the layout of the yielding mechanism is shown.

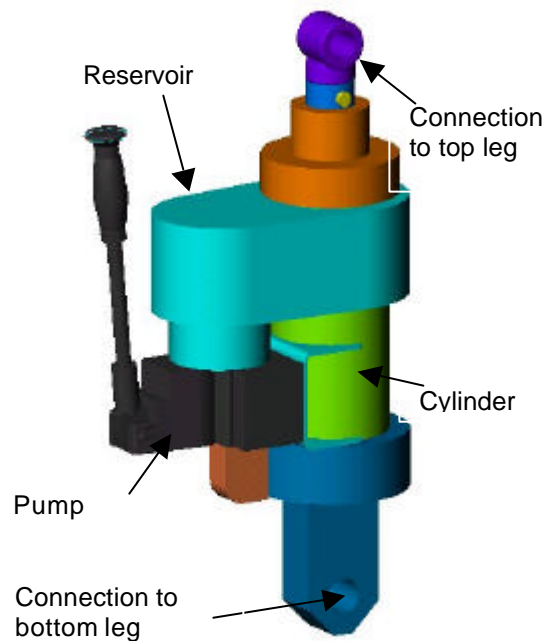

Figure 4-9: Yielding/preloading mechanism.

The structure of the yielding mechanism was designed making use of finite element analysis. The system was designed for 30 tons with a safety factor of 1.5 included. The cylinder has an internal diameter of 85 mm and a wall thickness of 10 mm. The shaft thickness connecting the cylinder to the top wishbone is 40mm. A v-pack seal with a capability of 70 MPa and a maximum tolerance of 0.1 mm on diameter between cylinder and piston is used. On the low pressure side of the cylinder a sliding bush is used (diameter 40 mm and 40 mm long) for stabilizing against buckling. A wiper seal is also fitted to prevent dust from entering the assembly. See figure 4-10.

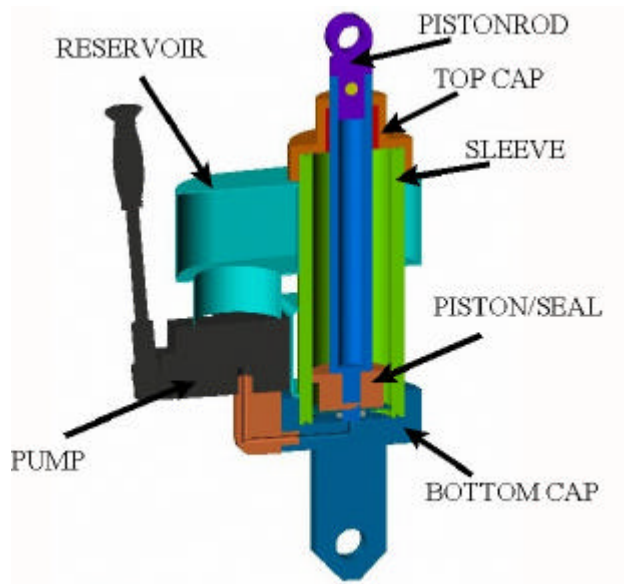

Figure 4-10: Layout of hydraulic cylinder.

A commercially available hydraulic pump (Simplex P170) with a built in release valve, is used to release the pressure. The release valve is set at a pressure of 70 MPa. The system can slow yield at a rate of 30 mm/day. The oil is released into the reservoir, which is placed behind the cylinder and the pump is gravity fed from the reservoir.

To load the cylinder a commercially available double acting pump is used – Simplex P170. For quick setting the pump displaces 45.9 ml/stroke at low pressure and 3.9 ml/stroke at high pressure during loading. With the current configuration 45.9 ml/stroke is the equivalent to 7.5 mm travel of the piston rod. The oil is pumped from the reservoir into the cylinder. The detail drawings of the yielding mechanism are shown in Appendix D.

4.2.3 Walking mechanism

The forward or backward movement of the roof support system is achieved via a walking beam. The two adjacent units are connected via a parallelogram to create a walking beam. During forward movement the one unit is collapsed and hangs from the other while it is manually cranked forward. To collapse the unit the oil pressure in the yielding cylinder is released via a manually operated release valve and the legs of the wishbone are then pulled together by two coil springs located on either side of the yielding cylinder. Each unit has a separate yielding system and the yielding mechanisms of the two adjacent units are not connected.

Two cranks manufactured from mild steel connect the two adjacent support systems to form a parallelogram and walking beam. The cranks are connected to the support systems at the hinges between the top and bottom leg of the wishbone and the top leg and the headboard. See figure 4-11. The cranks have an eccentricity of 150 mm, which results in an incremental movement of 300 mm per step. The incremental movement is limited by the height available after the system is collapsed. Enough room to crank it while hanging is needed. Another limiting factor on the forward movement is the amount of slow and rapid yield that must be provided for, i.e. 350 mm in total. The system is manually cranked by placing a lever (crow bar) into a pipe in the crank between the top and bottom leg of the wishbone. The detail of the crank is shown in Appendix D.

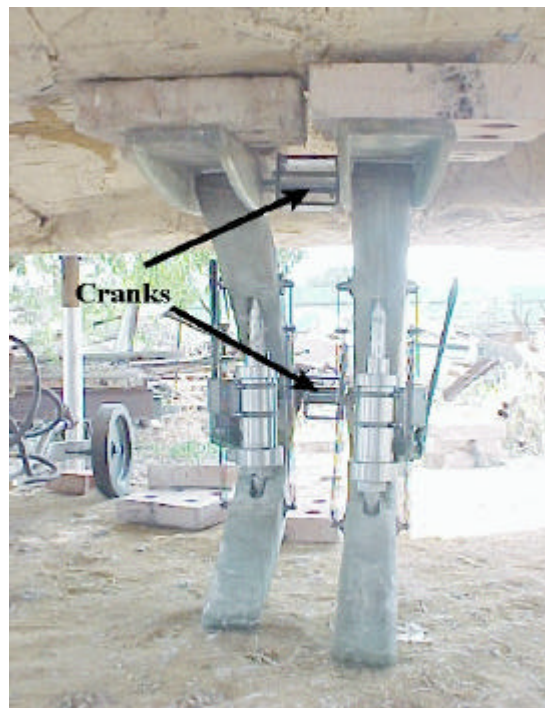

Figure 4-11: Placement of cranks between roof support units to form walking beam.

4.3 Build sub-components

4.3.1 Structural components

The structural components, the top and bottom leg of the wishbone as well as the headboard, were built from two types of glass fibre, 600 WR and glass tape UD 642, 190mm wide and an Epoxy Vinyl Ester Resin, Derakane Momentum 411-350. For ease of manufacturing, discrete steps were used to increase the thickness of the beam where required. This means that a single pattern can be used for each twenty layers of glass, thus reducing the cutting time, and reducing the packing time.

Steel moulds were made to improve the product, and to ease the process of packing the glass and foam core. This means that more control is available on the amount of glass going into the product, which in turn means that repeatability of products is improved. In figure 4-12 a photo of the top and bottom leg of the wishbone and the headboard is shown.

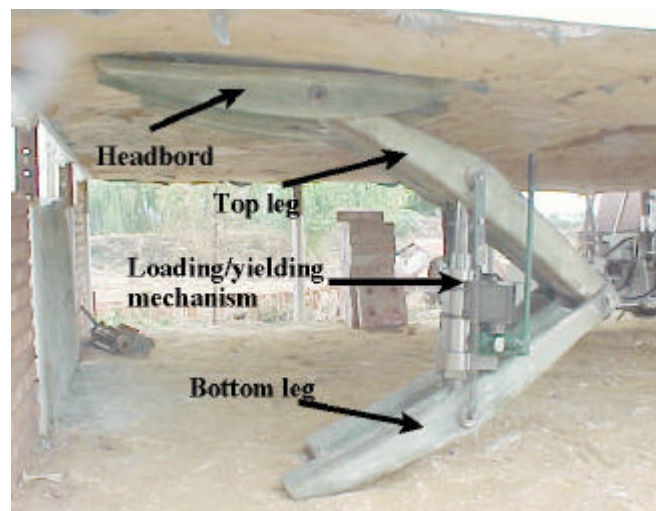

Figure 4-12: Photo of top and bottom leg of wishbone and headboard.

4.3.2 Yielding mechanism

A St52 steel tube with a ID of 85mm and a wall thickness of 10mm was used to machine the hydraulic cylinder. The piston, rods and connecting pieces were manufactured from EN9 steel and the reservoir from mild steel. The sub-system consisting of the hydraulic cylinder, relief valve, pump, reservoir and connecting pieces was assembled and commissioned. The photo in figure 4-13 shows the assembled yielding mechanism.



Figure 4-13: Photo of assembled yielding mechanism.

4.3.3 Walking mechanism

The cranks connecting the two adjacent roof support systems and forming the parallelogram of the walking beam were manufactured from mild steel. Figure 4-14 shows a photo of a connecting crank.



Figure 4-14: Photo of connecting crank for parallelogram of walking mechanism.

4.4 Test sub-components

The structural components, the top and bottom leg of the wishbone and the headboard, and the yielding mechanism were tested individually. The walking mechanism was not tested individually as the integrated system is required for it's testing.

4.4.1 Structural components

Test rigs were built to test these structures in the servo hydraulic test facility of the University of Pretoria.

Lower and upper leg of wishbone

Initially the two legs were tested to determine the correct lay up of the glass layers. In figure 4-15 the force displacement characteristics of the lower and upper legs are shown. The displacement was measured in the centre of the beams.

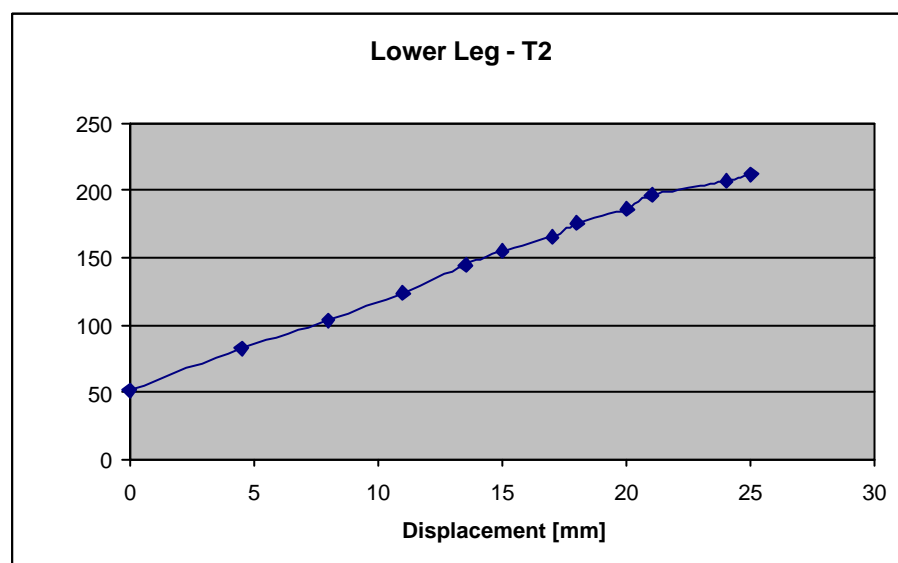

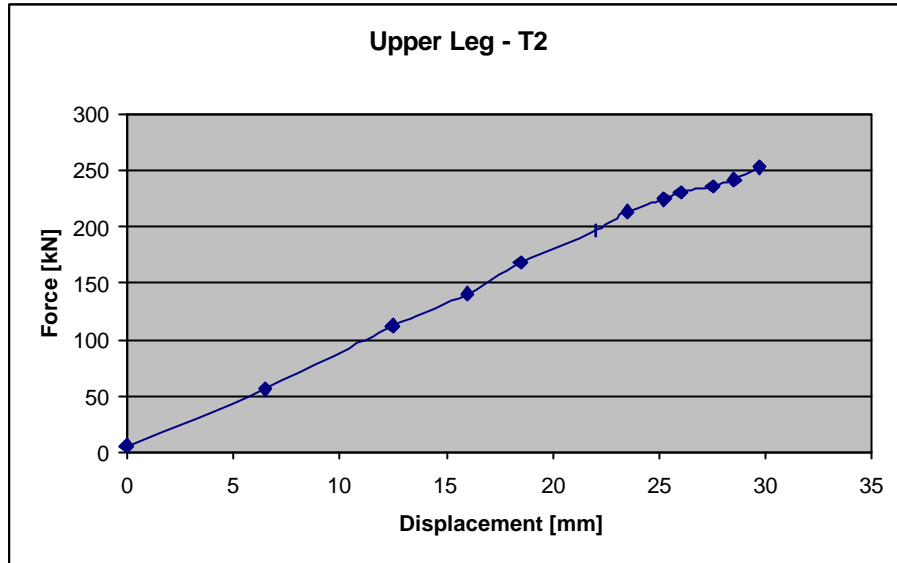

Figure 4-15: Force/displacement characteristics of lower and upper leg.

For the testing of the wishbone a test rig was built where the two legs are connected as in the roof support system. A 50 ton servo hydraulic actuator exerts a preset force at a set speed on the system. In figure 4-16 the test rig with the upper and lower leg of the wishbone is shown with the headboard. The test was conducted with 5 cycles at a speed of 0.1 m/s with a maximum force of 10 tons and one cycle at a speed of 0,5m/s with a maximum force of 20tons.

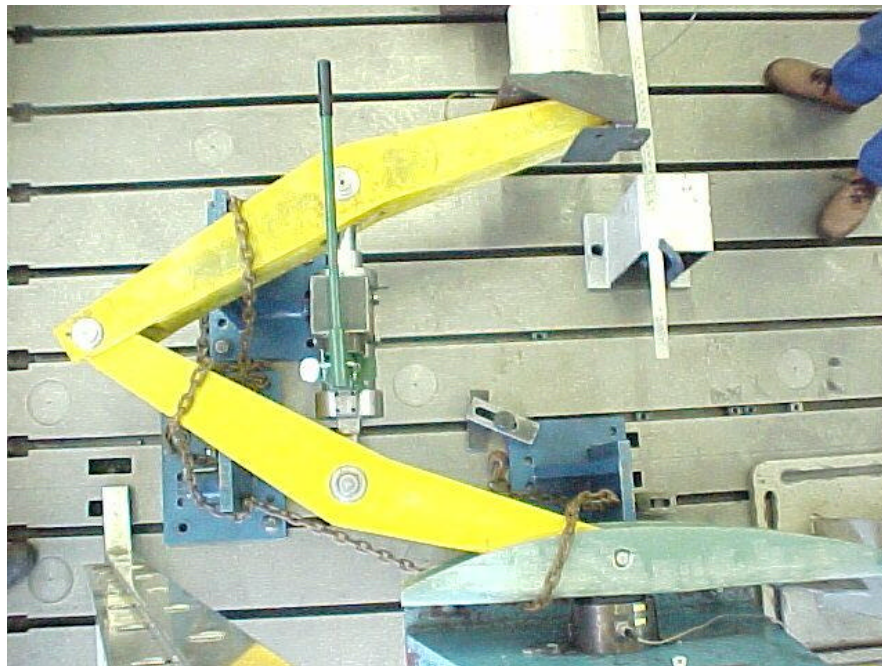

Figure 4-16: Test set up of wishbone in servo hydraulic test facility.

During the testing the top leg failed at approximately 12 tons. In figure 4-17 the failure of top leg is shown. The main cause of failure was the fibre orientation in the hinge area where the fibres did not have sufficient coverage in all directions. This was corrected during the design review.



Figure 4-17: Failure of top leg in hinge area.

Headboard

A test rig was built where the headboard is supported at the tips and the servo hydraulic actuator exerts a force in the middle of the headboard. The displacement was measured in the middle of the headboard. A maximum deflection of 5 mm was achieved with a force of 20 tons.

4.4.2 Yielding mechanism

The yielding mechanism was tested in a servo hydraulic press of the servo hydraulic test facility of the University of Pretoria. The yielding mechanism was compressed at a constant speed of 10 mm/min and the force displacement characteristics was recorded. See figure 4-18. After reaching the required pre-stress force a relative constant force is maintained. The incremental drop of force happens when the release valve opens to release the pressure.

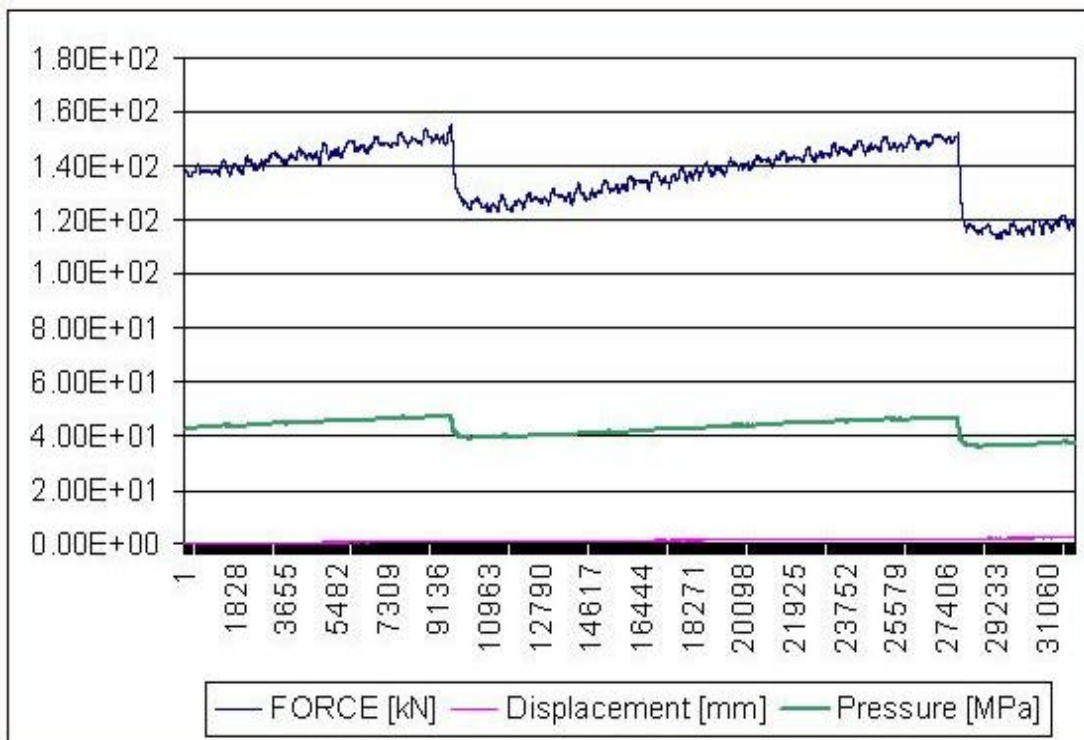

Figure 4-18: Force displacement characteristics of the hydraulic yielding mechanism.

4.5 Build prototype

The three sub-systems, the glass fibre structural components, the yielding mechanism and the walking beam mechanism were integrated. The prototype consists of two roof support units connected by the cranks forming the parallelogram of the walking beam. One roof support unit consists of the top and bottom leg of the wishbone, the headboard and the yielding mechanism. These sub-systems were all individually tested as described in paragraph 4.4. After the failure of the first prototype during laboratory testing and the design review a second prototype was built. In figure 4-19 a photo of the prototype is shown.



Figure 4-19: Photo of prototype roof support.

5 SURFACE TESTING

5.1 Laboratory tests

The servo hydraulic test facility of the University of Pretoria was used for the static and dynamic testing.

5.1.1 Laboratory test rig

A test rig was built for the dynamic testing of the structural elements of the roof support system. A 50 ton servo hydraulic actuator is used to load the system. The actuator can apply 50 tons at a maximum speed of 1,5 m/s. Although this is not equivalent to the maximum speed of 3 m/s of a seismic event the results will give a good indication of the systems sensitivity to speed. In figure 5-1 the test rig is shown. The wishbone structure, top and bottom leg, are chained on to the block of the test facility and the actuator acts on the top leg as the headboard would.

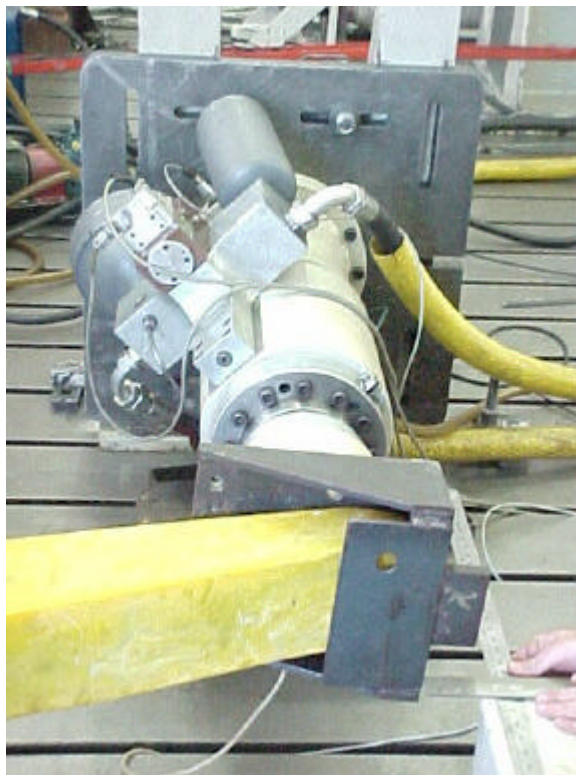

Figure 5-1: Laboratory test rig for dynamic load testing.

The yielding mechanism is not tested in this test rig, as it is slow yielding and acts as a relative solid structure at the higher speeds with the yielding mechanisms yielding the forces on the structure will be lower as the yielding mechanism acts as a damper absorbing the forces. The test of the yielding mechanism was done in a servo hydraulic press as described in paragraph 4.4.2.

5.1.2 Laboratory tests

The load cycle chosen for the testing of the structure of the roof support system was: 5 cycles at a relative low speed of 0.1 m/s to a maximum load of 10 tons to make sure the test set up is correct and then one cycle at a speed of 1.5 m/s up to a maximum loading of 20 tons.

Prototype 1

During the test of the first prototype the top leg of the wishbone broke at a loading of approximately 12 tons. In figure 5-2 photos of the damaged top leg is shown. The results of this test were used in the redesign of the system.



Figure 5-2: Photos of damaged top leg of wishbone.

Prototype 2

The second prototype withstood the test and the force/displacement characteristics of the test are shown and in figure 5-3. As can be seen from the graph a maximum displacement of 110 mm was recorded at a

loading of 23 tons. Although this is not the required 150 mm as specified the required deflection characteristics should be achieved with a refined design. The test was also recorded on video, which is attached to this report.

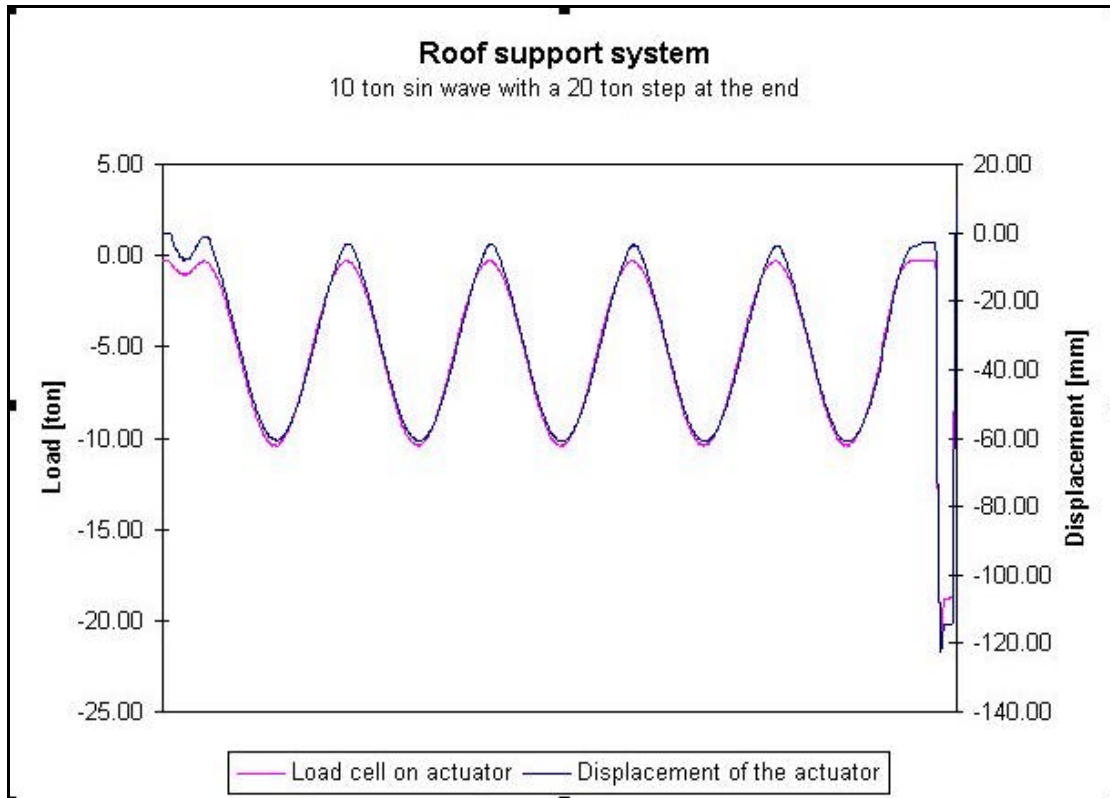

Figure 5-3: Force/displacement characteristics of prototype 2.

5.2 Tests in mock-up stope

5.2.1 University of Pretoria mock-up stope

A 6m x 6m mock-up stope with an adjustable stoping width from 0.9m to 1.4 m was built from concrete. The stope has undulating foot and hanging walls as well as fallouts. The specification and design of the mock-up stope is attached in appendix E.

The operation and handling of the system was successfully tested and demonstrated in the mock-up stope. In figure 5-4 a photo of the roof support system in the mock-up stope is shown. The system was advanced and retreated in all directions and places of the stope. While

moving the system through the fallout the void above the headboard is filled by lightweight concrete blocks of Duraset. See figure 5-5. The moving of the system is done by two persons. Results from the tests show that two workers can move the support units forward by 1m in a panel of 30 m with 20 roof support systems (pairs) in less than 45 minutes.



Figure 5-4: Photo of roof support system in mock-up stope.



Figure 5-5: Use of lightweight concrete blocks to fill void above headboard in fallout.

A video of the operation of the roof support system it attached to the report.

5.2.2 Kloof mine mock-up stope

The operation of the roof support system was also demonstrated to SIMRAC and invited guests in the training stope of Kloof mine. In figure 5-6 a photo of the roof support system at the Kloof mine mock-up stope is shown.



Figure 5-6: Photo of roof support system in training mock-up stope of Kloof mine.

6 RISK ASSESSMENT

A thorough risk assessment on the roof support system was done to provide guidelines for its manufacture, transport, use, and maintenance. The design team has approached the risk assessment on two fronts:

1. Globally, in order to cover the main issues concerned with the support from the design and development stage through to manufacture, transport, storage, and installation underground;
2. A prototypical risk assessment for equipment operation.

Both risk assessments follow the accepted international definition of risk as:

$$\text{risk} = \text{probability of event} \times \text{severity of consequences}$$

These are then ranked according to the tables given below to highlight the areas that need further attention.

Table 6-1: Occurrence Probability Categories (equivalent to frequency)

Category Ranking	Probability of Occurrence
1	Once in lifetime of mine
2	Once per year
3	Once per month
4	Once per day

Table 6-2: Consequence Severity Categories

Category Ranking	Severity of Consequences
1	Low: discomfort, no cost, or no production loss
2	Medium: Minor injury, minor cost, or minor production loss
3	Medium-high: serious injury, medium cost, or significant production loss
4	High: fatal injury, high cost, or total production loss

A risk table can be constructed from the two above tables, as shown in Table 6-3. The larger the value in the block, the greater the risk. When undertaking the risk analysis, the team has sought to rank the risk throughout the conceptual, design, manufacturing, transport, and operational stages of the support. There are four kinds of risk, namely financial, operating, health, and safety risks. All were considered

during the analysis, which helps to pinpoint problems that may arise in the process of developing and testing the new support.

		Severity of consequences			
		1	2	3	4
Probability of occurrence	1	1	2	3	4
	2	2	4	6	8
	3	3	6	9	12
	4	4	8	12	16

Table 6-3: Risk Table

The detailed global risk assessment appears in Appendix F. The assessment has highlighted the following areas for attention under the categories of severe risk (16 in Table 6-3), serious risk (12 in Table 6-3) and minor risk (9 or less in Table 6-3).

In the severe risk category there are three areas that need attention:

- Quality control during manufacture
- Incorrect installation
- Incorrect operating procedures

A total of seventeen areas pose a serious risk, namely:

- Corrosion potential
- Installation procedure
- Blasting
- Cost to equip panel
- Protruding parts
- Falling objects
- Floor conditions
- Roof conditions
- Brows
- Faults and joints
- Rock falls
- Rock bursts
- Corrosion
- Dip
- Rolls
- Training
- Taking short cuts in procedures

There is minor risk in four areas:

- Assembly in underground production section

- Cost of installation
- Damage by rockfalls
- Damage by rockbursts

The remaining areas considered in the risk assessment suggest minimal risk, and will not be considered any further.

The major areas that must be addressed in order to implement the new support system safely underground are quality of production, installation and operating procedures. If these three areas are covered properly, then all the lower risk categories are likely to be adequately covered as well. Quality control must be addressed now during development as well as the production stages, while the installation and operating procedures can only be developed during the practical testing phase. These two areas will be addressed in the next phase of development.

7 CONCLUSION AND RECOMMENDATIONS

A prototype roof support for tabular stopes was successfully developed and tested on surface. The primary output of this phase 1 of the project, to develop and surface test an effective roof support system and to do a risk assessment of the system, was successfully achieved. The roof support system is to be used in the face area of tabular stopes.

The roof support system consists of two similar support units connected via two crank mechanisms to each other. To move the system forward one support unit is collapsed and then hangs from the other to which it is connected. The collapsed unit is then manually cranked forward and pre-stressed. If the required position is still not achieved the other unit is released and moved forward. Each unit consists of a 200 x 1200 mm headboard supported by a “wishbone” structure (top and bottom leg) and a yielding mechanism that keeps the two legs apart. The yielding mechanism essentially is a self-contained hydraulic cylinder with a pump to load and pre-stress the unit and a relief valve to accommodate slow yielding of the system. Rapid yielding is mainly accommodated by the flexibility of the “wishbone” structure. The yielding mechanism is made from steel and the structural components; the two legs of the “wishbone” and the headboard are manufactured from glass fibre. Different models will be necessary for different stoping heights.

The tests and risk assessment of the roof support system identified certain areas that need to be addressed in order to implement the new support system safely underground. For the further development of the support system the areas that need attention are:

- Improved design taking the results of the tests into account.
- Change design of “wishbone” structure to decrease stiffness to achieve greater deflection.
- Quality control during manufacture.
- Correct and safe installation procedures.
- Safe operating procedures.
- Develop a different support system, which can be cheaper and lighter for rock fall conditions.

During phase 2 of the project working prototypes will be developed for underground evaluation.

8 REFERENCES

Daehnke A, Andersen LM, de Beer D, Esterhuizen GS, Glisson FJ, Grodner MW, Hagan TO, Jaku EP, Kuijpers JS, Kullmann DH, Peake AV, Piper PS, Quaye GB, Reddy N, Roberts MKC, Schweitzer JK, Stewart RD and Wallmach T (1998): *Stope Face Support Systems*. SIMRAC Final Project Report GAP330, Department of Minerals and Energy, Johannesburg, South Africa, December 1998.

Daehnke A, le Bron KB, and van Zyl M (1999): *Preliminary Investigation into the Zone of Support Influence and Stable Span between Support Units*. SIMRAC Final Project Report GAP627, Department of Minerals and Energy, Johannesburg, South Africa, October 1999.

Roberts MKC, Daehnke A, Archeampong E, van Zyl M, and Jager AJ (2000): Rock engineering specifications – GAP 708. First completed by Roberts on 5 June 2000, then modified by Roberts et al. on 8 June 2000. In: *SIMRAC Project GAP708 Report*, Department of Minerals and Energy, Johannesburg, 2000.

APPENDIX A: SUPPORT UNIT SPECIFICATIONS

Table 1: Design Specifications for Support Unit

(Version 2, after meeting 22/05/2001)

Definition: One support system consists of two support units connected to each other.

No.	Parameter	Quantity per support unit
1	Weight (per component)	< 30 kg
2	Colour	Bright
3	Corrosion	Resistant
4	Operator protection Rockfalls Rockbursts	Constant Full while moving unit Half while moving unit
5	Blast-on	Capability
6	Assembly	Simple
7	Maintenance	Simple
8	Stoping width range First design Extended design (with foot piece)	1100 – 1500 mm 1500 – 2500 mm
9	Loading eccentricity	20 degrees off-centre
10	Maximum spacing Dip Strike	2.0 m 2.0 m
11	Maximum uncovered hangingwall between units Breast mining Dip Strike Updip/downdip mining Dip Strike	1.2 m 0.7 m 0.7 m 1.2 m
12	Step distance (distance unit moves forward in one step)	750 mm
13	Step time	2 minutes
14	Maximum dip change rate	3 degrees/meter
15	Maximum dip of stope	45 degrees
16	Minimum pre-load force	100 kN/unit
17	Slow yield Rate Resistance force (to support deadweight of 2.0 by 2.0 by 1.5 m block with density 2700 kg/m ³ , and gravitational acceleration 9.81 m/s ²)	30 mm/day 100 kN/unit (200 kN/system)
18	Slow yield range	350 mm in 900 mm high

		stope
No.	Parameter	Quantity per support unit
19	Fast yield Rate Resistance force (to stop 2.0 by 2.0 by 2.3 m high block with density 2700 kg/m ³ moving down at 3 m/s in a distance of 200 mm)	3 m/s 200 kN/unit (400 kN/system)
20	Fast yield range	150 mm in 900 mm high stope
21	Maximum hangingwall and footwall contact stress	30 MPa

APPENDIX B: DESIGN OF COMPOSITE MATERIAL COMPONENTS

APPENDIX C: REDESIGN OF COMPOSITE MATERIAL COMPONENTS

APPENDIX D: DATAPAC OF ROOF SUPPORT SYSTEM

APPENDIX E: DESIGN AND SPECIFICATION OF MOCK-UP STOPE

DESIGN OF TEST STOPE

Most underground testing is hampered by delays because the tests have to be undertaken on a producing mine. Consequently, mine personnel are focused on their production targets, and do not have an interest in the tests. Underground excavations are in general not easily accessible, and it is not unusual to spend a whole day interacting with supervision and management, travelling to the test site, sorting out testing problems, and coming away with an hours' worth of testing or less. The team therefore decided at a meeting held at the University of Pretoria on Tuesday, 15th May 2001 to build a simple mock-up stope in which equipment testing and development could be carried out.

Although this option will cost extra money, which has not been budgeted for, the team felt that the savings in time wasted testing at an underground site would more than offset the building costs in the end.

Ignoring the range of tests and equipment development possible using the test stope, designing began with the face support system in mind. It was therefore decided that the footwall would be uneven and strewn with rocks of all sizes, simulating an unswept stope. The hangingwall would also be uneven, but would also be stepped, simulating joint-bounded falls of ground, thereby creating brows and overhangs, which the support system should be able to negotiate.

The test stope will be 6 metres by 6 metres square in order to provide enough space for moving support units forward, and permitting at least four support units to be installed in the stope at the same time. It will be closed off on the sides; therefore, noise tests of the silent drill will also be possible. The size of the stope requires that the maximum simulated joint bounded fall of ground thickness be limited to 0.3 metres. Any larger fall of ground height requires a thicker concrete hangingwall beam, which means higher cost, greater weight, and more construction difficulties.

The simulated joint-bounded fall of ground is shown in Figure 1. Half the hangingwall area will be relatively smooth, but undulating, as is seen in many underground stopes. This area will be used for standard installation/removal tests. The simulated joints are all planned to dip at 60 degrees, resulting in a triangular shaped cavity 30 cm higher than the rest of the stope. There is also a small 15 cm high brow separating the two halves of the stope. A triangular cavity was chosen so that the joints would be neither parallel nor perpendicular to the direction of mining, a situation that generally occurs underground. Support units will therefore have to negotiate the cavity at an angle.

The stope hangingwall is therefore at three different elevations, each part being separated by the 60-degree dipping joints. If the stoping width to the left of the simulated joint-bounded fall of ground were 1.00 metre, then the

elevations of the hangingwall in relation to the footwall would be as shown in the Figure 1. This variation of elevation provides an opportunity to test the support units in three stoping widths, namely 1.00 m, 1.15 m and 1.30 m. Lowering or raising the hangingwall will be made possible so that the stoping width range can be extended. Currently it is envisaged that the stope hangingwall will be adjustable from 0.60 m to 2.40 m in height, so that virtually the whole range of stoping widths encountered in the tabular hard rock mines can be simulated.

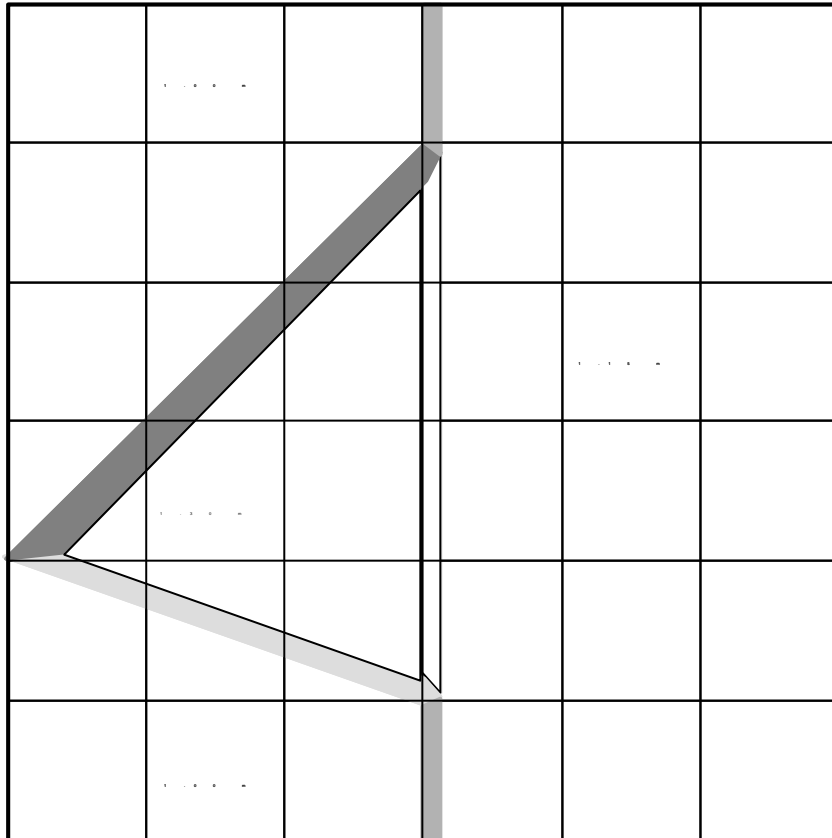

Figure 1: Plan of Simulated Joint-bounded Cavity in the Hangingwall of the Test Stope

The question of dip was also raised at the meeting of 15th May 2001, and it was decided at a later meeting held by the team on Tuesday 29th May 2001 that the cost of constructing the stope with a dip would be considerably larger than constructing a flat stope. Since both the hangingwall and footwall slabs would have to be reinforced with steel and be at least a metre thick to safely span 6 metres, their weight would be of the order of 800 kN each (approximately a mass of 80 tons). They would both require substantial support columns, and the way the slabs would be supported becomes complicated when they are inclined. It must be borne in mind that when four

fully stressed support units are installed in the stope, their combined resistance force is 1280 kN (approximately 130 tons), which is sufficient to lift the hangingwall slab. This means that the supports would have to lock the slabs in place. The same problem will be encountered in the case of the flat stope, but its construction should be cheaper, and quicker. Finally, it was agreed that the effect of dip is not crucial to the development of a viable support unit, and that this could wait until the underground testing phase of the system is undertaken.

APPENDIX F: DETAIL RISK ANALYSIS

RISK = (PROBABILITY OF OCCURRENCE) X (SEVERITY OF IMPACT)

PROBABILITY CATEGORIES

CATEGORY	PROBABILITY OF OCCURRENCE
1	ONCE IN LIFETIME OF MINE
2	ONCE PER YEAR
3	ONCE PER MONTH
4	ONCE PER DAY

SEVERITY CATEGORIES

CATEGORY	SEVERITY OF IMPACT
1	LOW: DISCOMFORT/ NO COST/ NO PRODUCTION LOSS
2	MEDIUM: MINOR INJURY/ MINOR COST/ MINOR PRODUCTION LOSS
3	MEDIUM-HIGH: SERIOUS INJURY/ MEDIUM COST/ MAJOR PRODUCTION LOSS
4	HIGH: FATAL/ HIGH COST/ TOTAL PRODUCTION LOSS

	Frequency	Severity	Risk	Preventative / Control measures
1.0 ENGINEERING ACTIVITIES				
Design criteria and specifications	1	4	4	Critical design review to be performed during next phase of project to eliminate possible shortcomings
Selection of component material	1	4	4	Critical design review to be performed during next phase of project to eliminate possible shortcomings
Cost of manufacturing	1	4	4	Processes to be optimised to minimise cost of manufacturing
Cost of transportation to mine site	4	2	8	Effective transportation systems and options to be evaluated to ensure minimum costs
Quality control	4	4	16	Effective quality control systems and procedures to be introduced during manufacturing processes
Time to manufacture: delivery period	3	2	6	Processes to be optimised to minimise time required for manufacturing
Storage of final product	4	1	4	Cost effective storage options to be investigated
Corrosion potential	4	3	12	Components to be corrosion resistant. Regular inspections to be performed to verify quality.
Availability of spares	3	2	6	Sufficient spare parts to be available at manufacturing and mine sites to ensure optimum efficiencies
Manufacturing processes: handling raw material	4	2	8	Specific safety procedures to be introduced
Manufacturing processes: handling toxic/dangerous material	4	2	8	Specific safety procedures to be introduced
Transport to mine site	4	2	8	Specific safety procedures to be introduced
Transport in mine shaft	4	2	8	Specific safety procedures to be introduced
Transport to underground production section	4	2	8	Specific safety procedures to be introduced
Assembly in underground production section	3	3	9	Specific safety, training and operating procedures to be introduced
Routine inspection and maintenance	4	2	8	Specific safety, training and operating procedures to be introduced

2.0 MINING OPERATING ACTIVITIES

Installation procedure	3	4	12	Effective operating and training procedures and standards to be introduced and maintained
Cost to install system underground	3	3	9	Effective operating and training procedures and standards to be introduced and maintained
Time to install system in panel	3	2	6	Effective operating and training procedures and standards to be introduced and maintained
Cost to maintain system	4	2	8	Effective operating and training procedures and standards to be introduced and maintained
Time to maintain system in panel	4	2	8	Effective operating and training procedures and standards to be introduced and maintained
Training of personnel	3	2	6	Detail and comprehensive training programmes to be compiled and introduced
Drilling of blast holes	4	2	8	Detail and comprehensive operating procedures and standards to be compiled and introduced
Explosives charging operations	4	2	8	Detail and comprehensive operating procedures and standards to be compiled and introduced
Blasting	4	3	12	Blast protection systems (eg blast barricades) to be introduced
Face cleaning	4	2	8	Detail and comprehensive operating procedures and standards to be compiled and introduced
Cost to equip panel	3	4	12	Effective design and manufacturing processes to be introduced to ensure that costs are kept to a minimum
Routine inspection and maintenance	4	2	8	Effective operating and training procedures and standards to be introduced and maintained
Protruding parts	4	3	12	Critical design review during next phase of project to eliminate or protect protruding parts
Falling objects	4	3	12	Detail and comprehensive operating procedures and standards to be compiled and introduced

2.0 MINING OPERATING ACTIVITIES (CONTINUE)

Difficult and uneven floor conditions	4	3	12	Methods of how to negotiate uneven floor conditions to be addressed during next phase of project
Poor roof conditions	4	3	12	Methods of how to negotiate poor roof conditions to be addressed during next phase of project
Brows	4	3	12	Methods of how to negotiate and handle brows to be addressed during next phase of project
Slips, faults	4	3	12	Methods of how to negotiate and handle slips and faults to be addressed during next phase of project
Making safe	4	2	8	Effective training programmes, operating procedures and standards to be developed and introduced
Ventilation and air flow	4	1	4	Effective training programmes, operating procedures and standards to be developed and introduced
Dust	4	1	4	Effective training programmes, operating procedures and standards to be developed and introduced
Moving forward or back	4	2	8	Effective training programmes, operating procedures and standards to be developed and introduced
Final removal	2	1	2	Specific safety, training and operating procedure to be introduced

3.0 NATURAL PROCESSES

Rock falls	3	4	12	Effective training programmes, operating procedures and standards to be developed and introduced
Rock burst	3	4	12	Effective training programmes, operating procedures and standards to be developed and introduced
Damage by rock falls	3	3	9	Effective training programmes, operating procedures and standards to be developed and introduced
Damage by rock bursts	3	3	9	Effective training programmes, operating procedures and standards to be developed and introduced
Water and flooding	2	3	6	Effective training programmes, operating procedures and standards to be developed and introduced
Explosions	2	3	6	Effective training programmes, operating procedures and standards to be developed and introduced
Underground fires	2	3	6	Effective training programmes, operating procedures and standards to be developed and introduced
Corrosion	4	3	12	Correct manufacturing, quality control, operating procedures and inspection standards to be introduced

4.0 HUMAN ACTIVITIES

Boycotts	2	2	4	Special standards and procedures to be developed and introduced on how to handle abnormal situations
Strikes	2	2	4	Special standards and procedures to be developed and introduced on how to handle abnormal situations
Sabotage	2	4	8	Quality control standards and procedures and routine inspections to be introduced
Training	4	3	12	Comprehensive training programmes to be developed to ensure that all personnel are competent to install, operate and maintain the system safely and effectively
Taking short cuts	4	3	12	Sufficient quality control and supervisory standards to be developed and introduced
Incorrect installation	4	3	12	Sufficient quality control and supervisory standards to be developed and introduced
Routine inspections and maintenance	4	2	8	Sufficient quality control and supervisory standards to be developed and introduced
Incorrect operating procedures	4	4	16	Sufficient quality control and supervisory standards to be developed and introduced