

Safety in Mines Research Advisory Committee

Final Report

**Deterioration and Discard of Mine
Winder Ropes
Volume 2**

M N van Zyl

Research Agency: Materials Science and Technology
Project Number: GAP324
Date: November 1997

Table of Contents

1	Introduction	3
2	Shaft sinking	3
2.1	Overview of the winding rope requirements for deep shaft sinking operations	3
2.2	Stage rope factors for deep shaft sinking operations	4
2.3	Load ranges acting in kibble winder ropes and proposals for new kibble winder rope regulations	4
2.4	Rope forces generated after brake control failure on kibble winders	5
2.5	Future direction of the investigation	6
3	Triangular strand ropes for deep shaft operations	6
Appendix AA:	Overview of the winding rope requirements for deep shaft sinking operations	
Appendix BB:	Stage rope factors for deep shaft sinking operations	
Appendix CC:	Load ranges acting in kibble winder ropes and proposals for new kibble winder rope regulations	

Appendix DD: Rope forces generated after brake control failure on kibble winders

Appendix EE: Triangular strand ropes for deep shaft operations - an initial study

1 Introduction

This Volume 2 of the GAP324 (1996) report discusses the parts of the project that dealt with the sinking of very deep shafts, and an initial study into the behaviour of triangular strand ropes for deep shafts.

These two parts of the project are discussed separately.

2 Shaft sinking

The proposed new statutory regulations for drum winder ropes will conceivably allow single lift shafts of as deep as 4 000 m. If such deep shafts have to be sunk in the conventional way, stages and kibles will be used.

The regulations governing the strength of ropes for stage and kibble winders were investigated under the auspices of a SIMGAP Engineering Advisory Group. The aims of the stage and kibble winder ropes investigation were to obtain appropriate rope load factors for deep shaft sinking operations and to obtain guidelines for drafting a code of practice for sinking winders that operate with lower static rope load factors than those required by the current regulations.

The measurement of the rope forces on stage and kibble winders had been carried out at three shafts as the initial part of the investigation (published in the GAP054 report).

2.1 Overview of the winding rope requirements for deep shaft sinking operations

This part of the investigation explored the requirements for operating winding ropes safely, the regulations that govern the strength of sinking ropes, examples of deep sinking installations, and the applicability of the rope condition assessment code of practice and the winder code of practice on shaft sinking ropes and shaft sinking installations.

The details of the investigation are given in Appendix AA. The views expressed in that appendix were largely influenced by the interviews that the author conducted with

members of the shaft sinking industry, visits to shaft sinking operations and observations while the field measurements were carried out.

It was concluded that it would be possible to sink shafts with stage and kibble winders in the conventional way to depths of 4 000 m, provided that appropriate rope regulations for such operations are instituted.

Recommendations were given on the scope of work that was required to obtain appropriate rope load factors and to draw up a code of practice for future deep shaft sinking operations.

2.2 Stage rope factors for deep shaft sinking operations

The current winder rope regulations governing the strength of stage winder ropes do not allow for realistic stage winder configurations for shaft depths greater than 2 500 m to 3 000 m. The mining industry in South Africa need regulations that will allow safe sinking operations with stages and kibbles to depths of 4 000 m.

The load factors for stage winder ropes were analysed in this part of the investigation. It was shown that a static rope load factor of 3 is required to operate a rationally sized stage at a depth of 4 000 m. It was further demonstrated that a static rope load factor of 3 is acceptable for such operations.

For stage winder operations that comply with the requirements of a code of practice, a static rope load factor of 3 was recommended.

Details of this part of the investigations are given in Appendix BB.

2.3 Load ranges acting in kibble winder ropes and proposals for new kibble winder rope regulations

In this part of the investigation, the load ranges of kibble winder ropes were analysed to obtain a basis for regulations that will allow the sinking of deep shafts with kibble winders. From the analysis, regulations for kibble winders were proposed, both for installations that will have to, and will not have to, comply with the requirements of a code of practice.

Details of the investigation is given in Appendix CC. It was shown that the proposed new rope regulations for drum winders that do not have to comply with the requirements of a code of practice are suitable and sufficient for kibble winder operations. These are a capacity factor of 8 and a rope load factor of 4,5.

It was further proposed that kibble winders should only have to comply with the requirements of a code of practice once a depth is reached at which the rope load factor is less than 4,5. The rope load factor "formula" for the ropes of such kibble winder installations should follow that of a capacity factor of 8. One of the requirements of the code of practice for sinking winders will have to be a limit of 15% for the load range ratio of the kibble winder rope.

2.4 Rope forces generated after brake control failure on kibble winders

Permanent drum winders that will operate on a shaft are often used for the sinking of the shaft as well. The winding duties during shaft sinking could be lighter than the permanent shaft duty. This part of the investigation was carried out to determine whether these different winding duties could result in significantly different rope forces after brake control failure.

A further objective of the investigation was to determine what winder brake requirements have to be included in a code of practice for sinking winders other than those of the winder code of practice. The findings of this investigations are applicable to kibble winders as well as permanent drum winders.

Details of the investigation are given in Appendix DD.

It was shown that, if current drum winder brake design criteria are employed, rope forces in excess of 60% of the breaking strength of the rope after brake control failure will only be generated under very special circumstances.

It was further shown that slack rope could occur at the front end of the rope after brake control failure on all drum winders currently in operation, whether they are used for permanent winding duties or for shaft sinking. Double drum winders with two brakes are the most susceptible.

On new drum winder designs, slack rope after the occurrence of brake control failures can be prevented if the regulations governing drum winder brakes are revised to allow rational disc brake configurations.

It was concluded that very little can be included in a code of practice on brake control failures, because their occurrences will not generate excessive rope forces, and nothing can be done (at present) to prevent the occurrences of slack rope at the rope front ends on existing drum winders.

2.5 Future direction of the investigation

The SIMRAC investigation on stage and kibble ropes for future deep shafts continued in 1997 under the SIMGAP project GAP418.

The objectives of GAP418 are the proposal of rope load factors for stage ropes and kibble ropes that will allow the sinking of 4 000 m deep shafts, and the drafting of a code of practice for such winding installations.

Because the proposal for kibble winder rope factors followed logically from the analysis of load ranges of section 2.2, and proposed rope factors for stage ropes followed from the investigation of section 2.3, and because GAP418 (1997) continued on GAP324, the proposals of rope load factors for deep shaft sinking winders were completed and included in this report.

3 Triangular strand ropes for deep shaft operations

Nearly all permanent drum winders in this country use triangular strand ropes. The torque-tension characteristics of triangular strand ropes cause laylength changes in the rope when installed in a shaft, and cause torque to be generated at the fixed rope ends. The general belief in the mining industry is that the laylength changes and the generated torque will limit the depth at which triangular strand ropes can be used. Suitable alternative rope constructions for permanent drum winder operations have not yet been established.

In this initial study, which is detailed in Appendix EE, the possibility of using triangular strand ropes at shaft depths greater than current experience was investigated. The

behaviour of triangular strand ropes in ultra deep shafts was examined, and potential problems that could be experienced under such operating conditions were analysed.

The investigation was based on an experience at Loraine Gold Mine where a triangular strand rope lost spin by accident to create a rope laylength much longer than as-manufactured. The rope had operated satisfactorily for three years in that condition and was still in service at the time of the writing of this report.

It was concluded that there is very little reason why triangular strand ropes will not operate satisfactorily at shaft depths of at least 3 200 m. It was further concluded that it is very possible that triangular strand ropes could be used at shaft depths of 4 000 m. It was further shown that the anticipated laylength problems of triangular strand ropes in deep shafts could be lessened by manufacturing ropes with longer laylengths than current practice.

Although SIMRAC decided not to sponsor continued research in this field, recommendations for future research were included in Appendix EE.

Appendix AA: Overview of the winding rope requirements for deep shaft sinking operations

CONTENTS

	Page
1. INTRODUCTION	1
2. DEFINITIONS	2
3. ENSURING SAFETY	3
4. GENERAL ASPECTS OF SINKING WINDING AND WINDERS	5
4.1 FINDINGS OF THE FIELD INVESTIGATIONS	5
4.1.1 Stage rope forces	5
4.1.2 Kibble winder rope forces	5
4.2 FORCES AND DETERIORATION MECHANISMS OF STAGE ROPES	6
4.3 FORCES AND DETERIORATION MECHANISMS OF KIBBLE WINDER ROPES	6
5. REGULATIONS	8
5.1 RELEVANT REGULATIONS	8
5.2 DISCUSSION OF THE REGULATIONS	8
5.2.1 General	8
5.2.2 Rope discard	8
5.2.3 Stage rope regulations	8
5.2.4 Drum winder rope regulations	9
6. EXAMPLES OF DEEP SINKING INSTALLATIONS	10
6.1 KIBBLE WINDERS	10
6.2 STAGE WINDERS	11
7. APPLICABILITY OF THE CODES OF PRACTICE	14
7.1 ROPE CONDITION ASSESSMENT CODE OF PRACTICE	14
7.2 WINDER CODE OF PRACTICE	15

8.	CONCLUSIONS	17
9.	RECOMMENDATIONS	18
9.1	STUDY SINKING OPERATIONS	18
9.2	PROPOSE SAFETY FACTORS	18
9.3	DRAFT REQUIREMENTS FOR THE CODE OF PRACTICE	18
9.4	FURTHER RECOMMENDATIONS	19
10.	REFERENCES	20

1. INTRODUCTION

The proposed new statutory regulations for drum winder ropes¹ will conceivably allow single lift shafts of as deep as 4 000 m. These new regulations were formulated after studies into dynamic forces acting on drum winder ropes and deterioration patterns on discarded ropes. Drum winders that use these regulations will also have to conform to a code of practice². If such deep shafts are sunk in the conventional way, stages and kibbles will be used.

The regulations governing the strength of ropes for stage and kibble winders are being investigated under the auspices of a SIMGAP Engineering Advisory Group. The object of the investigation of stage and kibble winder ropes is to draft regulations and/or codes of practice that will allow safe sinking operations with sinking winders that operate with lower rope factors than those required by the current statutory regulations.

Very little information was available on the rope forces generated in the stage and kibble winder ropes of sinking operations. The SIMGAP Engineering Advisory Group therefore requested that the investigation initially concentrate on the measurement of the rope forces at sinking operations. The rope forces on both stage winders and kibble winders were measured at three sites.^{3,4,5}

The information accumulated through interviews with members of the shaft sinking industry, visits to shaft sinking sites and observations made during the field measurements were used in the production of this report. This report examines the current state of the investigation and determines what needs to be done to finally draw up a code of practice that will allow deep sinking operations.

The safety referred to in this document concerns the safety of the winding ropes.

For the purposes of this report, it is assumed that a deep sinking shaft will only have access through the top of the shaft and that there will be no outlets or access at intermediate levels.

2. DEFINITIONS

Some of the terms used in this report are defined as follows:

Front end: That end of the rope attached to the kibble, or the section of rope near the kibble end of the rope. For stage ropes the front end will be those sections of rope near and at the stage.

Back end: That end of the rope attached to the drum, or the section of rope near the drum when the kibble is at its lowest position in the shaft. For stage ropes the back end will be those sections of rope near and in the headgear.

D/d ratio: The diameter of a winder drum or rope sheave divided by the diameter of the rope.

Initial breaking strength: The actual breaking strength of a rope when new. Also called the new rope breaking strength.

Capacity factor: The initial strength of the rope divided by the maximum static load it has to support at its front end.

Safety factor: The initial strength of the rope divided by the maximum static load it has to carry (i.e. the maximum weight that it has to support at its front end plus the maximum length of the suspended rope). This factor decreases for both kibble winder and stage ropes as the depth of the shaft increases. It is also common practice to use the stage loadcell readings to calculate the safety factor for the stage ropes.

Load range: This is the difference between the largest and smallest force in a section of rope that occurred during one complete winding cycle. When the static rope forces are used to determine the load range it will be referred to as the static load range, and when actual rope forces are used it will be referred to as the dynamic load range. Load range is normally expressed as a percentage of the initial breaking strength of a rope.

Permanent installations: Permanent installations refer to those winding systems that operate in shafts after sinking and equipping of a shaft have been completed.

Sinking installations: This term refers to those winding systems used for shaft sinking.

Permanent winder: The drum winders of a permanent installation.

Kibble winder: The drum winder used for kibble winding during shaft sinking operations. Although this winder is often the permanent winder, the term "kibble winder" is used to distinguish between the operations of a winder and its ropes during shaft sinking operations and their use at a permanent installation.

3. ENSURING SAFETY

The generally accepted concept of safe winding rope operation is given in this section to establish a common viewpoint from which safety issues can be addressed.

A winder installation will operate safely, i.e. the rope will not fail, if:

The rope forces generated during acceptable operation of the winder remain smaller than the strength of the rope at any point along the length of the rope.

The rope forces generated during acceptable operations of winders at sinking installations can be controlled, and include the following cases:

- Normal winding operations: For the kibble winder this will include lifting of kibbles and drilling rigs, tipping, accelerating, decelerating, and travelling. For the stage ropes this will include the actions of lashing, kibble crosshead interactions, and starting, winding and stopping during stage movements.
- Emergency braking: The deceleration of the kibble winder drum is normally controlled during emergency braking (trip-outs) and the rope loads are predictable. The largest rope forces under normal winding conditions occur when emergency braking takes place near the bottom of the shaft with the maximum allowable load descending. On a stage winder, a normal stop during winding is the same as an emergency stop.
- Extreme conditions: These are situations that cannot be avoided altogether. Failure of the brake control system during emergency braking, resulting in uncontrolled braking, is currently the only such known condition. It may never occur in the life of a winder, but the brakes of the winder have to be designed such that the rope forces generated under these conditions will not result in rope failure.

Previously it was believed that the winder motor torque developed during flash-overs (short circuits) could produce rope forces of extreme magnitudes, but research by Hamilton et al⁶ has shown that the rope forces generated under such circumstances are of acceptable magnitudes.

Situations like the occurrence of slack rope at permanent winding installations could generate rope forces large enough to fracture a rope, irrespective of the condition or size of the rope. Nothing can be done to guard against failure of the rope under such conditions except to avoid these conditions. Such conditions are not regarded as "acceptable operations of the winder".

The rope of a kibble winder (and any drum winder) deteriorates with every winding cycle. The remaining strength of the rope will therefore continually decrease with usage. If such ropes are left in service indefinitely, they will eventually fail under the loads generated during normal winding operations.

The deterioration mechanisms of stage winder ropes differ from those of drum winder ropes, because stage ropes mainly fulfil a static function. The strength of these ropes, however, also reduces with time and usage because of the actions of corrosion and the kibble guide rope functions.

Rope loads can be controlled, but because the strength of the rope reduces with time and usage, the importance of regular assessment of the condition of winding ropes is obvious in ensuring the safety of a winding operation.

The rate of deterioration under normal winding conditions should also be controlled such that adequate rope strength is maintained from one rope inspection to the next.

Both stage and kibble ropes are subject to accidental damage from items falling down the shaft. Poor operation of a winder installation could also lead to unexpected local rope deterioration. Such deteriorated points could lead to accelerated subsequent deterioration, and unexpected and undetected loss in rope strength. Such incidents should be avoided as far as possible by adequate and enforced precautions.

In summary, the safety of winding ropes will be ensured if:

- The rope forces are kept within acceptable limits.
- The rate of normal rope deterioration is controlled.
- The condition and the remaining strength of the full working length of a rope are assessed accurately and at appropriate intervals.
- The operations of a winder and its surroundings are maintained such that accidental damage and unexpected acceleration of the deterioration of the ropes are prevented.
- The occurrence of abnormal incidents is avoided.

4. GENERAL ASPECTS OF SINKING WINDING AND WINDERS

4.1 FINDINGS OF THE FIELD INVESTIGATIONS

Rope forces were measured at three sinking installations,^{3,4,5} on both the kibble winder ropes and the stage ropes. The rope forces were monitored at each of the three sites for 24 hour periods. This section summarises the findings.

4.1.1 Stage rope forces

The stage rope forces were measured during all types of sinking and stage operations, i.e. during blasting, lashing, stage raising and lowering, kibble crosshead interactions, and water hoisting.

The peak-to-peak magnitudes of the dynamic components of the stage rope forces measured during any stage operation were never greater than 2% of the breaking strength of the ropes. The rope forces can therefore be regarded as static. The rope dynamics measured during stage movements, expressed as percentages of the rope breaking strengths, were actually less for the deeper shafts compared to that of the shallower shaft.

4.1.2 Kibble winder rope forces

The kibble winder rope forces were measured during all types of normal sinking operations, which are hoisting of loaded kibbles and tipping, hoisting water, transporting personnel and material, transporting jumbo drill rigs, running the winder with only the crosshead attached at the rope end, and emergency braking with loaded kibbles, both ascending and descending, near the bottom of the shaft.

The dynamic rope components measured during lifting of loaded kibbles and jumbo drill rigs were insignificant because of the slow winder speeds employed during these operations. Tipping and hoisting water also did not generate rope dynamics of any significance. The only event, apart from emergency braking (trip-outs), which produced any significant rope dynamics was acceleration of the winder.

The dynamic rope forces generated by kibble winders are actually less severe than those of permanent drum winders because of the absence of skip loading dynamics. For the rest of the operation of kibble winders, the dynamics are the same as that of permanent drum winders.

The extraction of dynamic load ranges from the measured rope force data^{3,4,5} is recommended for an improved understanding of kibble winder rope forces.

Irresponsible use of the winder, like using it to pull loads horizontally in shaft stations, may cause localised damage to the rope. It cannot generate the same magnitude of rope forces than during emergency braking because of the limited torque of the winder motor compared to the brakes. Such types of operations were (of course) not carried out during the measurements at the three sinking installations investigated. It would, however, not make any difference to the magnitudes of the rope forces measured, because, for example, pulling with the winder at a load or obstruction at shaft bottom until the winder trips on over-current is not more severe than the winder tripping on over-current when accelerating a loaded kibble. Tripping on over-current was measured on five occasions on one of the kibble winders investigated.⁴

4.2 FORCES AND DETERIORATION MECHANISMS OF STAGE ROPES

The nature of sinking operations is such that accidental damage to the stage ropes is possible, such as by objects falling down the shaft or the kibble hitting the stage rope during tipping. Very little more than avoiding such situations is possible.

If the kibble crosshead is separated from the kibble and falls onto the stage, it could generate relatively large rope forces, but such situations are normally prevented through proper interlocking devices on the kibble winder.

If the movement of the stage is accidentally impeded during stage raising larger-than-normal rope forces will be generated by the action of the stage winder motor. The magnitude of these forces depends on the current limit setting of the motor, or the winding system may be such that this situation can be detected by the stage rope loadcells. If the movement of the stage is impeded during stage lowering, a situation similar to slack rope on permanent drum winders may occur. All such situations can be avoided, or their effects minimized, if the stage rope forces are actively monitored.

During normal sinking operations, the stage ropes can deteriorate through corrosion, the kibble guide rope function, by the rope actions during movement of the stage and by dynamics on the stage ropes.

The experimental investigations have shown that all sinking actions generate very little stage rope dynamics, and that the rope forces can be regarded as static. It is unlikely that the dynamics of stage operations will contribute to stage rope deterioration.

During movement of the stage, the ropes are subjected to bend-over-sheave and bend-over-winder-drum actions as well. The D/d ratios of stage ropes are normally in the order of 45. Because the sinking shaft continually gets deeper, a given section of rope is only subjected to the bending actions for a limited period when that section of rope operates at or near the winder drum. If the stage winder is of the commonly used multi-wrap friction drum type, a section of rope will only experience an estimated 1 000 bending cycles during the time that the shaft is sunk. This is far less than at any other type of winding installation.

The kibble guide rope function fulfilled by the stage ropes could also lead to rope deterioration, but the indications are that the rope guide materials currently employed by the industry do not cause undue rope deterioration.

Corrosion therefore seems to be the greatest contributor to the deterioration of stage ropes because of the wetness of sinking shafts.

4.3 FORCES AND DETERIORATION MECHANISMS OF KIBBLE WINDER ROPES

In sinking operations, crosshead detachment and subsequent collision with the kibble after free-falling could lead to excessive rope forces, but, as was mentioned before, such situations are normally prevented through proper interlocking devices on the kibble winder.

The experimental investigations have shown that the rope forces generated in kibble winder ropes are practically the same as those of permanent drum winders. The differences are that a kibble rope is not subjected to the same loading dynamics as rock winders, and that the total load at the end of a kibble winder is often completely removed.

The deterioration mechanisms of kibble winder ropes are basically the same as those for permanent drum winder ropes. A summary of these mechanisms can be found in a report by Hecker and Van Zyl.⁷

On kibble winders non-spin ropes have to be used, while triangular strand ropes are normally used on permanent drum winder installations. The torque-tension-twist characteristic of triangular strand ropes is the primary reason the wear and plastic deformation is spread evenly around the circumferences of these ropes. The orientation of a section of live rope on the drum is also continually changed. The direction of bending of the rope on the drum or a headgear sheave, whether such bending may lead to deterioration or not, is for the same reason also continuously changed. These conditions will be different for non-spin ropes and the deterioration patterns could therefore be different.

The other difference between permanent drum winding and kibble winding is that the depth of wind continuously gets deeper. Dead turns will all the time be introduced into the live section of the rope. It is common for a kibble winder drum to have 1 500 m of dead turns immediately after installation of the final sinking ropes. For a kibble winder rope, the static load range will remain constant with increasing depth but the dynamic load range at the back end of the rope will increase.

On a permanent winder, a reasonable life (to discard) of a rope or set of ropes is normally known from the performance of previous ropes on that winder. Because the depth of the wind increases continuously on a kibble winder, no two sets of ropes will have the same operating conditions. A reasonable rope life (to discard) for a set of ropes on a kibble winder can only be established from similar types of winder installations. However, the rope life on similar winders could be influenced by a variety of factors as was shown for permanent drum winders used for rock hoisting.⁸

Although it has not been proven that load range exclusively determines the life or rate of deterioration of drum winder ropes, it is an aspect of winding that can be controlled and limited. The *Capacity factor* did this to a large extent in the past, and the "formula" of the new regulations was drawn up such as to limit the dynamic load range of drum winder ropes.

5. REGULATIONS

The regulations of Chapter 16 of the Minerals Act (Act 50 of 1991) that are relevant to the ropes used for shaft sinking are discussed in this section.

5.1 RELEVANT REGULATIONS

The proposed regulations were obtained from the Chief Director, Mining Equipment, Department of Mineral and Energy Affairs (DMEA). They will not necessarily be promulgated in the given form.

5.2 DISCUSSION OF THE REGULATIONS

Only the regulations that have a direct bearing on the winding ropes used for sinking are discussed in this section.

5.2.1 General

Any shaft has to have a second outlet for personnel. On a sinking installation with one kibble winder and a stage winder, the stage winder is the second outlet, and consequently the DMEA considers the stage winder to be "a winder" and the stage ropes to be "winding ropes".

5.2.2 Rope discard

Proposed Regulation 16.28 requires that:

The strength of a winding rope or balance rope shall be assessed in accordance with an approved safety standard and may not be used if the breaking strength thus assessed at any point in the rope, is less than nine-tenths of the initial breaking strength.

The referred safety standard is the Rope Condition Assessment Code of Practice⁹ that is currently being finalised. This code has been drawn up on experience gained largely from triangular strand ropes operating at permanent drum winder installations. The discard criteria of the code of practice aim at determining when a rope has reached a 10% reduction in breaking strength. It is generally accepted in the winding and rope industry that the deterioration of a winding rope accelerates once it has reduced in strength by more than 10%.

This regulation is applicable to kibble winder ropes and to stage ropes, and it should be noted that it applies to any point along the whole length of a rope (and not just to the front end of a drum winder rope).

5.2.3 Stage rope regulations

The regulation that determines the strength of a stage rope is proposed Regulation 16.33, which reads:

A guide rope shall not be used in a winding system if the breaking strength at any point in such ropes is less than five times the effective combined weight of the rope and its tensioning weight. This provision shall not apply to any guide rope which is also used as

a winding rope to raise or lower a stage, in which case the breaking force at any point in the rope shall not be less than 4,5 times the effective combined weight of the length of winding rope, and its share of the combined weight of the stage and attachments, the maximum permitted number of persons and the load of material.

The DMEA said that the breaking force referred to in the above regulation is the initial breaking strength of the rope, and the static safety factor of 4,5 for a stage rope is therefore an installation factor.

Although the above regulation contains nothing on stage ropes that are not used as guide ropes, it is the appropriate regulation that determines the strength of stage ropes.

For the sake of interest, it is noted that old (actually still current) Regulation 16.40 required a safety factor of 5 at discard for stage ropes, as opposed to the installation factor of 4,5 in the proposed regulations.

5.2.4 Drum winder rope regulations

The strength of the ropes of kibble winders is currently determined by the same regulations that apply to permanent drum winder installations, because a kibble winder also "*allows for the periodic testing of the winding rope*". The old regulation (16.34) required a capacity factor (at discard) of 9,0 for rock hoisting and 10,0 for men, and a static factor (at discard) of 4,5 for rock and 5,0 for men.

In the proposed regulations, the same factors apply to men and rock, and the factors have been changed from "discard factors" to "installation factors". Installation factors are calculated on the initial breaking strength of a winding rope. The proposed Regulation 16.29.1 requires a capacity factor of 8,0 and a safety factor of 4,5.

To allow vertical drum winder installations to operate at depths beyond that would be allowed by the above static factors, a "formula" for the rope safety factor was derived.¹ This formula (proposed Regulation 16.29.2) requires the winder rope to have a safety factor of $25\,000/(4\,000+L)$, where L is the depth in metres.

The derivation of the formula was based on limiting the dynamic load range on any part of the winding rope of a permanent winder installation used for rock hoisting to 15% of the initial breaking strength of the rope. A safety factor according to the "formula" may only be used if the winder installation complies with an approved safety standard pertaining to winder performance, operation, testing and maintenance.² This safety standard will be referred to as the winder code of practice. In its current form, this code deals specifically and only with permanent drum winder installations.

Strictly speaking, Regulation 16.29.2 should not be used for kibble winder ropes because the derivation of the "formula" is not applicable to the load ranges of kibble winder ropes. For the same attached load, the load range on a kibble winder will be higher than that of a permanent drum winder because load at the end of a kibble rope is often completely detached.

The DMEA is aware of the above problem and indicated that this could be addressed in a dedicated code of practice for sinking operations.

6. EXAMPLES OF DEEP SINKING INSTALLATIONS

A multiple of factors determines the amount of rock that has to be pulled out of the shaft during shaft sinking operations, e.g. the diameter of the shaft, the required rate of advance, the depth, and the number of kibble winders.

The mass of the stage is determined by the shaft diameter and the number of operations that have to be carried out on the stage simultaneously, e.g. lashing, water pumping, and lining.

It is not the intention in this section to design a shaft sinking winder layout, but rather to give an idea of the limitations created by the regulations governing the rope safety factors, and limitations due to the rope manufacturing processes. Greater detail on the sizing of kibbles, stages and sinking winders for a required sink can be obtained from sinking operators, or, for example, from a paper by Lane.¹⁰

In their catalogue, *Steel wire ropes for mine winding*,¹¹ Haggie Rand make recommendations on winding ropes for shaft sinking. They recommend the use of galvanised ropes where possible. Such ropes are not available in tensile grades greater than 1 900 MPa. Currently Haggie Rand is researching the manufacture of galvanised ropes that will have tensile grades of 1 950 MPa and possibly 2 000 MPa.

Deep sinking operations would require ropes of the highest tensile grade possible.

6.1 KIBBLE WINDERS

Kibbles with their crossheads typically make up 20% to 30% of the maximum allowable attached mass at the end of a rope. Examples are: A two kibble winder system with 4 240 kg kibbles and 14 000 kg payloads at Vaal Reefs 11 Shaft,³ and a single kibble winder system with 5 260 kg kibbles with 18 000 kg payloads at West Driefontein 9 Shaft.⁵ In both these cases 54 mm ropes were used. (In contrast, skips make up 30% to 50% of the allowable attached load on permanent drum winder installations.)

A 2 000 MPa 54 mm non-spin rope has a breaking strength of the order of 2 550 kN and a mass per unit length of 13,2 kg/m. If this rope is used with the first of the two example cases above (4 240 kg and 14 000 kg payload), and the depth is extended to 4 000 m, the capacity factor will be 14,3 and the safety factors at the different depths will be as shown in Table 1. If the same kibble and payload as above are used at a capacity factor of 8, the required rope strength will be 1 430 kN. A 2 000 MPa, 41 mm rope with a mass of 7,6 kg/m will have the required strength. The safety factors at various depths for this combination are given in Table 2.

Table 2 shows that, with a capacity factor of 8, the safety factor limit of 4,5 will be reached at 1 850 m. The static factor at 4 000 m will be 3, which is beyond any current winding experience, and may be too low for practical winding.

Table 1, on the other hand, shows that if the rope and kibble system as used at Vaal Reefs 11 Shaft³ were extended to a depth of 4 000 m (assuming that sufficient winder motor power was available), the system could have operated to 3 000 m under a safety factor of 4,5. At a depth of 4 000 m, the static safety factor would have been 3,66. This is within the experience gained with triangular strand ropes on a permanent winder installation at Elandsrand (operating at a static factor of 3,5).

TABLE 1: Safety factors for an attached load of 18 240 kg rope strength of 2 550 kN and rope mass of 13,2 kg/m

Depth (m)	Safety factor
0	14,27
500	10,48
1 000	8,28
1 500	6,84
2 000	5,83
2 500	5,08
3 000	4,50
3 500	4,04
4 000	3,66

TABLE 2: Safety factors for a capacity factor of 8,0 i.e. an attached load of 18 240 kg rope strength of 1 430 kN and rope mass of 7,6 kg/m

Depth (m)	Safety factor
0	8,00
500	6,62
1 000	5,65
1 500	4,92
2 000	4,36
2 500	3,92
3 000	3,56
3 500	3,25
4 000	3,00

In sinking operations the rope forces increase as the shaft depth increases, and for any system of kibles and ropes, the safety factors will decrease as the depth increases. The back ends of kibble winder ropes are only subjected to the actions of a full depth winding cycle towards the latter part of a shaft sinking operation. A permanent drum winder installation, in contrast, operates at its design safety factors during every winding cycle.

If the deterioration of non-spin ropes on kibble winders at great depths is not totally different to the deterioration at shallower winds, 4 000 m deep sinking operations could be carried out with kibble installations comparable to those currently used. Static safety factors of 3,5 will allow such operations.

Assuming that proper rope conditions assessments are performed, the ropes of deep kibble winders will operate safely if the same precautions are adhered to as that of the winder code of practice. They are as follows and will be explained in greater detail further on in this report:

- The rate of deterioration of the ropes should be limited so that excessive deterioration could not occur from one rope inspection to the next.
- The peak dynamic forces acting in the rope should not cause permanent damage to the rope.
- No foreseeable condition should lead to failure of the rope.
- Regular inspections and maintenance of the winding system should ensure that the above requirements are always met.

6.2 STAGE WINDERS

Sinking stages are relatively heavy and have to be suspended from multiple rope falls. Eight to twelve falls of rope are common. Most stage winders are two-rope friction type winders, and deep sinking operations using this system therefore require very long stage ropes. For the same depth and number of rope falls, the ropes of a two-rope stage system has to be twice as long as the ropes of a four-rope system.

The stage has to be raised and lowered two to three times per day for blasting. The raising height is normally in the order of 100 m, which means approximately 500 m of stage rope has to be pulled in and let out during every stage movement. On a two-rope system the raising and lowering of the stage are relatively simple operations. If four ropes are used with two winders, these procedures are more complicated. The two-rope system is preferred by industry.

The maximum length of stage ropes manufactured by Haggie Rand is currently not strictly limited by the total mass of a rope, but more by the length of one strand in the rope. The size of a fully laden bobbin that can be located in the rope closing machine is restricted, which in turn limits the length of a rope that can be manufactured.

According to Haggie Rand, the longest 18 strand "fishback" non-spin rope that they can manufacture currently is a 43 mm diameter rope 16 000 m long. A rope of this size and of a tensile grade of 2 000 MPa will have a breaking strength of around 1 600 kN and a mass of 8,46 kg/m.

The stage at Vaal Reefs 11 Shaft³ had an "all-up" licensed mass of 110 000 kg, the shaft diameter was 11 m, and two kibble winders operated through that stage. The loadcell reading at that sinking operations actually showed a stage mass of the order of 130 000 kg towards the end of the sinking operations. If this stage is used with the long ropes from Haggie Rand, and if it is assumed that the rope can be made slightly longer so that four falls could fit into a 4 000 m shaft, then the safety factor at various stage depths will be as in Table 3 for stage masses of 110 000 kg and 130 000 kg.

TABLE 3: Stage rope safety factors for stage masses of 110 000 kg and 130 000 kg, and a rope breaking strength of 1 600 kN, a rope mass of 8,46 kg/m and 8 falls of rope

Depth (m)	Safety factors for stage masses of:	
	110 000 kg	130 000 kg
0	11,87	10,05
500	9,08	7,92
1 000	7,35	6,61
1 500	6,17	5,64
2 000	5,32	4,92
2 500	4,68	4,37
3 000	4,17	3,92
3 500	3,77	3,56
4 000	3,43	3,26

Vaal Reefs actually used two 42 mm diameter ropes of 2 100 MPa tensile grade, five falls per rope and reached a depth of close on to 2 500 m.

The regulations (safety factor of 4,5 for stage ropes) limit the depth of the stage of the above example to around 2 500 m.

The measurements at the three sinking operations have shown that stage ropes are not subjected to dynamics of any significance. Stage rope forces can be regarded as static and stage ropes have corrosion as the main deterioration mechanism. There should be examples of other industries that

use ropes in a basically static condition at static safety factors of 3, e.g. bridge ropes and counterweight ropes of large cranes. It should therefore be possible to show that stage ropes could be used at static factors of as low as 3 without venturing into unknown territory.

If lower factors for stage ropes are proved to be safe, then it would be plausible that stages could be used at great depths without the necessity of having to use two winders and four ropes or other alternative methods.

The most popular alternative stage roping method is to have sheaves or terminations at intermediate levels in the shaft to reduce the required length of the stage ropes. Members of the shaft sinking industry have expressed their concerns regarding the use of this method. If no other access to that intermediate level in the shaft is available and only one kibble winder is used then this method would not be allowed by the regulations. The greater concerns have however been the cost and time delays involved.

Conventional sinking with a stage suspended from the headgear of a shaft seems entirely feasible and safe, provided that rope overloads and accidental damage are prevented, and that rope condition assessments are carried out at appropriate intervals.

Furthermore, on drum winders it is not possible to simulate the effects of deep winds at lower factors on shallow winding depths because of the effects of multi-layer coiling. It is however possible to conduct an authentic field trial on stage ropes at lower factors.

7. APPLICABILITY OF THE CODES OF PRACTICE

According to the (proposed) regulations, the condition of all winding ropes have to be assessed according to a code of practice⁹. If, further, the ropes of a winder are selected according to the "formula" of Regulation 16.29.2, the winder and its ropes have to conform to a code of practice *pertaining to winder performance, operation, testing and maintenance*.²

The applicability of these two codes, in their present forms, to the ropes of sinking installations is briefly examined in this section.

It is assumed that the reader is familiar with the contents of these codes of practice.

7.1 ROPE CONDITION ASSESSMENT CODE OF PRACTICE

The code is applicable to both stage and kibble winder ropes. This code aims at discarding a winding rope when it has lost 10% of its strength, and to establish appropriate testing intervals. It was mentioned that the rope discard criteria of the code have largely been based on experience gained with triangular strand ropes operating on permanent drum winders.

The parts of the code that need to be revised or amended to include stage ropes and kibble winder ropes are not discussed in detail, but are simply listed. There may be further sections that require attention as well.

Definitions:

Dead turns; live turns; normal rope life; winding rope.

Discard criteria for winding ropes:

Internal (non-visual) broken wires.

Evaluation of the effects of corrosion and the experimental determination of the conversion factors for the non-spin ropes used at sinking operations.

Rate of deterioration.

Assessment intervals:

What would be the normal life of a rope at a sinking operation?

Rope sections to be assessed:

Lowest loading station should be defined, and the examination of the dead turns should be clarified.

Preparations for assessment:

Assessment procedures for stage ropes should be included.

Assessment procedures:

How should internal broken wires be dealt with?

Self study courses:

Include stage winders.

A part that may require greater attention is the electromagnetic (EM) assessment of stage winder ropes and the intervals at which these ropes are to be assessed. The DMEA said that they would

prefer a six-monthly EM test. Some members of the shaft sinking industry said that the EM testing of multiple falls of rope on a deep shaft stage would require a considerable time, and suggested that the stage could be hoisted to the surface at yearly intervals during which time the ropes could be EM tested and re-lubricated.

An attempt should also be made at obtaining rope samples from discarded kibble and stage ropes to establish the efficiency of EM testing in determining the condition of these ropes. Currently the research on this subject is largely directed at triangular strand ropes operating on permanent drum winder installations.

7.2 WINDER CODE OF PRACTICE

The winder code of practice was drafted to fulfil the following primary requirements. They are the same requirements as those listed in section 3, which discussed the requirements for safe winding rope operation.

- *The rate of rope deterioration should be limited so that excessive deterioration could not occur from one rope inspection to the next.*
The "formula" of Regulation 16.29.2 was derived such that it would limit the dynamic load range of the ropes of a permanent drum winder installation, hoisting rock, to 15% of the initial rope breaking strength, and therefore control the rate of rope deterioration.
- *The peak rope forces acting in the rope should not cause permanent damage to the rope.*
The code prescribes that rope forces generated during (controlled) emergency braking shall not exceed 40% of the initial breaking strength of the rope.
- *No foreseeable condition should lead to the failure of the rope.*
The code prescribes that the brakes of a winder are designed such that, after failure of any one component of the brake control system, the rope forces generated during emergency braking shall not exceed 60% of the initial rope breaking strength.
- *Regular inspections and maintenance of the winding system should ensure that the above requirements are always met.*

The winder code of practice further aims at eliminating poor operation of a winder installation that could lead to unexpected rope deterioration. As mentioned, localised deteriorated points lead to accelerated subsequent deterioration, and unexpected and undetected loss in rope strength.

Deep sinking operations (the conventional way) would require regulations other than those of Regulation 16.33 (stage) and Regulation 16.29.1. Therefore, the regulations for such operations first need to be finalised before a code of practice for deep stage winding and deep kibble winding can be drawn up, or before the current winder code is adapted to provide for these winders as well.

The winder code of practice, in its present form, has been written specifically for permanent drum winder installations, and for the dynamic load ranges experienced during rock hoisting at permanent winder installation. The winder code of practice does not consider stage winding, and Regulation 16.29.2 is not strictly applicable to kibble winding. However, at least the following sections of the winder code of practice require attention if the code has to apply to kibble winders:

Legal requirements: Rope strength criteria.

Rope selection: Rope construction; rope torque.

Design considerations: Winding plant layout (environmental factors; the use of deflection sheaves and rollers); headgear sheaves (size of deflection sheaves; sheave inertia); brakes (failure mode analysis); rope terminations (hand splices for non-spin ropes); conveyance guiding systems (crosshead and guide design); conveyances; conveyance loading.

Monitoring and control systems: Winder performance monitoring (rope force measurement); electrical drive control system requirements; skip load measurement and skip loading control.

Performance: Winding control system (enforced speed reduction; slack rope); conveyance loading performance.

Operation: Special procedures; hoisting heavy loads; ropes (installing; back end cutting).

Inspection, testing and maintenance: Conveyance guide systems (guide ropes); conveyances; conveyance loading systems.

One further area of the winder code of practice that will require additional attention is the rope force that can be generated during failure of the brake control system of kibble winders. In drawing up the winder code of practice, the rope forces that could be generated during brake control failure had been analysed for permanent drum winder installations,¹² from there the prescribed rope force of 60% of breaking strength mentioned earlier in this section.

Permanent winders are designed to fulfil a specific duty and the brakes can therefore be designed such that the requirements of the code are met. On the other hand, when permanent winders are used for sinking operations, the duties of the winders (and their brakes) are often greater than that required by the sinking operations. This could even be more so when a (permanent) BMR winder is used for kibble winding during sinking with only one rope on each side of the drum.

A number of typical cases should be analysed to verify if the prescription of the allowable rope forces during brake control failure of the winder code of practice is appropriate for kibble winders.

It was mentioned earlier in this report that the DMEA has said it would be in order if a dedicated code of practice for deep sinking operations is drawn up. This code would then take care of both stage and kibble winders.

8. CONCLUSIONS

The sinking of shafts, in the conventional way, with kibble winders and stages to depths of 4 000 m is possible.

Regulations that will allow safe deep sinking operations have to be established. In doing this, it would be irrational not to use the same basic concepts¹ as those used when the "formula" of Regulation 16.29.2 was established and the basic requirements of the winder code of practice² was drawn up.

A decision has to be made by the industry and the DMEA whether a dedicated code of practice for sinking operations at reduced rope factors will be drawn up, whether the current winder code of practice will be adapted to include kibble winding and stage winding, or whether a separate code will only be drawn up for stage winding while kibble winding is included in the current winder code of practice.

The code of practice for rope condition assessment requires attention before it can be used for stage ropes and the ropes of kibble winders.

9. RECOMMENDATIONS

To provide the required knowledge to establish appropriate safety factors for deep sinking operations and to draft the requirements for the codes of practice for sinking operations, the following are recommended:

9.1 STUDY SINKING OPERATIONS

This should be a continuation of the interaction with industry that provided much of the contents of this report. This report will be circulated to the shaft sinking industry, the DMEA, winder and rope manufacturers, and other concerned parties. Their responses will be collected through personal interviews and discussions.

At the same time input will be obtained for the contents of the code of practice for deep sinking operations, and on the concerns and suggestions for rope safety factors for such operations.

The collective response from all concerned parties will be collated and contentious points will be isolated and discussed to reach possible and early consensus.

9.2 PROPOSE SAFETY FACTORS

The rope and load factors of other industries that use ropes in a static condition should be investigated to assist in determining appropriate and safe factors for stage ropes.

The load ranges of kibble winder ropes should be established. This can be done theoretically and by analyses of the data collected during the field investigations at the three sinking sites.

Emergency braking after brake controller failure on permanent winders used for kibble winding should be investigated to establish whether further precautions would be required.

Safety factors for the ropes of both deep kibble winding and deep stage operations will be proposed.

For the proposed new factors for stage and kibble winder ropes, theoretical analyses of the rope forces that could be generated in the ropes for different winding operations will be carried out to show that the forces will be within the accepted limits.

The findings and proposed new regulations will be put together in a report for approval by the DMEA and industry.

9.3 DRAFT REQUIREMENTS FOR THE CODE OF PRACTICE

Irrespective whether the code of practice for deep sinking installations will be combined with the winder code of practice or not, the requirements and preliminary contents for the code of practice for sinking winding will be drawn up. The contents will be based on the current winder code of practice, the views from the industry and the DMEA, and on the findings of the proposed rope force investigations.

Once the preliminary contents and the requirements have been drawn up, the actual code of practice for deep sinking operations can be produced.

It is recommended that the *SABS Technical Committee TC 801.19 Wire Ropes* should be responsible for the code of practice for sinking operations. The drawing up of the rope condition assessment codes of practice and the winder code of practice were and are carried out under the directive of this committee.

As with the winder code of practice, it is recommended that a special working group with specialised task groups be appointed to draw up the code of practice for sinking operations.

9.4 FURTHER RECOMMENDATIONS

The recommendations that follow fall outside the current scope of the SIMGAP stage and kibble winder project.

- The collection and testing of discarded stage and sinking ropes should be added to the discarded rope testing project.
- The code of practice for the assessment of winding ropes should be adapted to include the requirements of stage and kibble winder ropes.
- After new rope factors for deep sinking operations have been established, an analysis should be carried out on the attainable sinking rates with winders operating under these factors. This will help industry to establish the economic viability of single shaft sinking operations for 3 000 m to 4 000 m depths.

10. REFERENCES

1. Hecker, G F K: *Motivation for proposed changes to Chapter 16 of the Minerals Act; Rope safety regulations for drum winders.*
CSIR Contract Report MST(92)MC1674, June 1993.
2. Hecker, G F K and Van Zyl, M N: *STATUS REPORT: Safety standard for the performance, operation, maintenance and testing of mine winding plant.*
CSIR Contract Report No. 940248, November 1994.
3. Van Zyl, Mike: *Rope force measurements during shaft sinking operations at Vaal Reefs 11 Shaft.*
CSIR Contract Report No. 950373, December 1995.
4. Van Zyl, Mike: *Rope force measurements during shaft sinking operations at West Driefontein 10 Shaft.*
CSIR Contract Report No. 960374, January 1996.
5. Van Zyl, Mike: *Rope force measurements during shaft sinking operations at West Driefontein 9 Shaft.*
CSIR Contract Report No. 960375, February 1996.
6. Hamilton, R: *Investigation of fault torques on mine winding motors.*
Mechanical Engineering Department, Anglo American Corporation.
(to be published).
7. Hecker, G F K and Van Zyl, Mike: *Drum winder rope test facility: A feasibility study.*
CSIR Contract Report MST(93)MC1233, January 1993.
8. Van Zyl, Mike: *A life prediction model for drum winder ropes.*
CSIR Contract Report MST(91)MC662, February 1991.
9. SABS xxxx:199x: South African Standard: *Code of practice: Condition of steel wire ropes on mine winders.*
10. Lane N M: *Constraints on deep level sinking - An engineering point of view.*
Cementation Mining: Paper delivered at a meeting of the Institute of Certificated Mechanical and Electrical Engineers, February 1990.
11. *Steel wire ropes for mine hoisting:* Haggie Rand catalogue, November 1987.
12. Kroonstuiwer, J: *Investigation into rope forces generated during emergency braking events.*
CSIR Contract Report No. 940189, September 1994.

Appendix BB: Stage rope factors for deep shaft sinking operations

CONTENTS

	Page
1. INTRODUCTION	1
2. STAGE WINDERS	2
2.1 LAYOUT	2
2.2 OPERATION	3
3. GENERAL DISCUSSION	4
3.1 STATUTORY REGULATIONS	4
3.2 STAGE ROPE LENGTH	4
3.3 ROPE TENSILE GRADE	4
3.4 SHAFT ACCESS	5
3.5 STAGE MASS	5
3.6 STAGE WINDERS	5
3.7 OTHER STAGE ROPE CONFIGURATIONS	6
3.8 ROPE FACTORS OF OTHER INDUSTRIES	6
4. STAGE ROPE FORCES AND DETERIORATION	8
4.1 STAGE ROPE FORCES	8
4.2 STAGE ROPE DETERIORATION	8
4.3 ROPE SAFETY	9
5. STAGE ROPE SAFETY FACTORS	10
6. ROPE FAILURE	13
7. CONCLUSIONS AND RECOMMENDATIONS	16
8. REFERENCES	17

1. INTRODUCTION

The current regulations governing the strength of stage winder ropes do not allow for realistic stage winder configurations for shaft depths greater than 2 500 m to 3 000 m. The mining industry in South Africa need regulations that will allow safe sinking operations with stages and kibbles to depths of 4 000 m. These future deep shafts could be large production shafts or smaller ventilation shafts.

The regulations governing the strength of ropes for both stage and kibble winders in vertical shafts are being investigated under the auspices of a SIMGAP Engineering Advisory Group. The objective of the investigation is to draft regulations and codes of practice that will allow the sinking of deep shafts. Regulations that will allow deep shaft kibble winder operations have been proposed¹.

The rope safety factors for stage winder ropes are analysed in this report, so that appropriate new factors for deep shafts can be proposed. To be in line with the proposed kibble winder regulations¹, stages could be allowed to operate under the normal stage rope strength regulations until a certain depth is reached. From that point onwards, the operation will have to comply with the requirements of a code of practice together with the rope factors associated with that code of practice. This proposed code of practice for sinking winder operations will be drawn up in the course of 1997 as part of the SIMGAP investigations.

Rope safety and some rope strength requirements for the sinking of deep shafts were considered in a previous report² for both stage and kibble winders. The rope forces on stage winders and kibble winders were measured at three sites^{3,4,5} as part of the 1995 investigations.

Only rope loads and rope safety are considered in this report. The feasibility of, and the cost and time required to sink a 4 000 m shaft fall outside the scope of this investigation.

2. STAGE WINDERS

2.1 LAYOUT

The general layout of one of the ropes of a typical stage winder is shown in Fig. 1. In this case the stage winder is a double drum friction winder and the rope has four falls in the shaft.

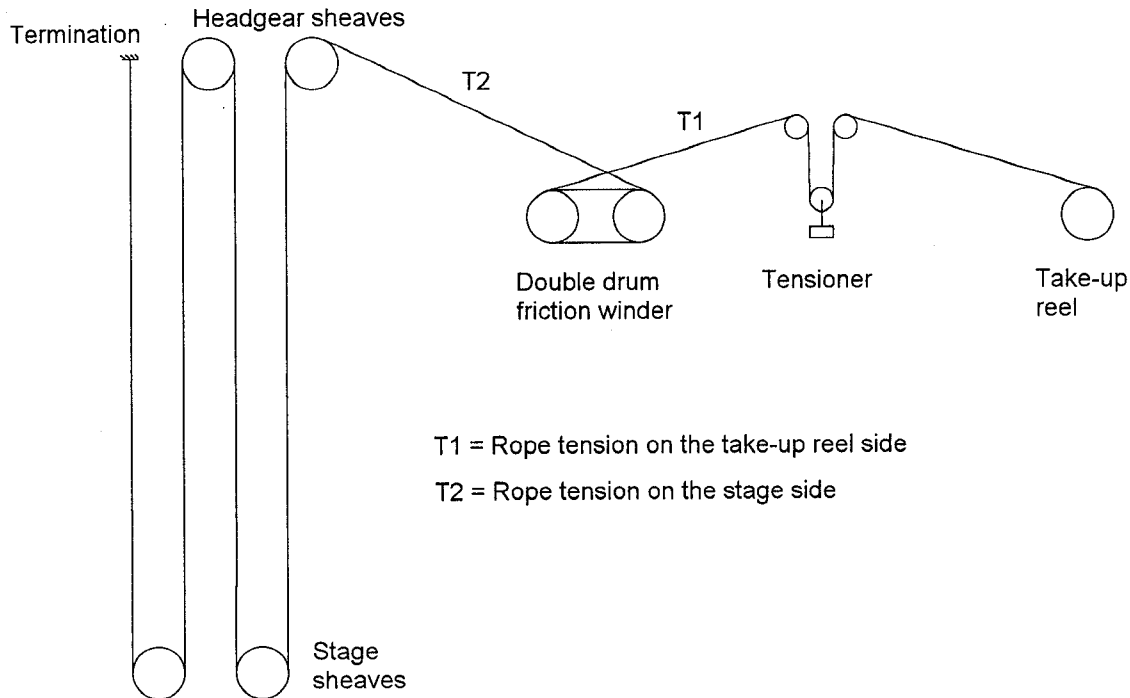

Figure 1: General layout of a stage rope with four falls and a double drum friction winder.

A stage winder has two ropes per winder. The two sides can be unclutched, so that only one rope can be moved if required. This is necessary for the equalisation of the two rope tensions.

A stage winder with two ropes and 4 to 5 falls per rope, generally provides the rope forces to perform the required stage winding duty. Two separate stage winders (four ropes in total) have been used in the past. In such a case the two stage winders can be coupled electrically, mechanically, or not at all. It is a matter of ease of operation and cost.

The "rope pull" at the stage winder (T_2 in Fig. 1) is the same as the rope tension of the stage ropes in the headgear. This rope tension is determined by the stage mass, the total number of rope falls in the shaft, and the weight of a fall of rope.

Each rope of a double drum friction winder normally has 4 to 5 wraps of rope around the drums. The friction coefficient between the rope and a winder drum, and the rope "pull" required by the stage and suspended rope length in the shaft determines the amount of weight required at the tensioner. The motor drive and the brakes of the take-up reel have to be able to support the rope tension produced by the tensioning weight.

A chimes wheel, or fleeting wheel winder can also be used in stead of the double drum friction winder. A chimes wheel winder has one concavely shaped drum (mostly elliptical) for each rope

in place of the two grooved drums of the double drum friction winder. A chimes wheel will also have four to five wraps of rope around the drum, depending on the friction coefficient and the tensioning weight. During winding the rope slips continuously in the concave in order to establish equilibrium.

A double drum friction winder is more costly than a chimes wheel winder, but the general opinion of the operators of sinking installations is that double drum friction winders are preferred. The reason being that the behaviour of the double drum friction winder is more predictable. The relative slip between the rope and the winder drum is greater in the case of a chimes wheel winder than for a double drum friction winder. Rope wear (and deterioration) should therefore be less for ropes operating on the latter.

The stage winder, tensioner and take-up reel can also be replaced with a stage hoist that feeds the rope directly from its drum to the headgear of the shaft. A slow speed geared double drum winder with two ropes will be used in such a case. A deep shaft with multiple falls of rope requires quite a long length of rope. The total rope length that can be coiled onto the drum of these stage hoists is a limiting factor on the achievable shaft depths. The stage ropes have to be wound onto the drums of these hoists at the start of the sinking operations. If low rope tensions are used during this process, coiling problems may be experienced when the rope tensions become larger as the shaft gets deeper.

The type of stage winder that is used does not influence the stage rope safety factors that will be required for future deep shafts. If special precautions are required when a specific type of stage winder is used on a deep shaft, such precautions can be included in a code of practice.

Loadcells for stage rope force monitoring are currently common on stage winders. They are used to measure the total suspended mass and can therefore check on stage "fouling". They are also used to equalise the rope tensions in the stage ropes.

If two double drum kibble winders operate in a sinking shaft, at least 8 falls of rope are required to provide enough guide ropes for the four kibbles.

2.2 OPERATION

The stage operations that are discussed here are those that determine the actions of the stage ropes. These actions, in turn, determine the deterioration that the stage ropes can accumulate during stage raising and lowering.

The stage is normally positioned some distance above the shaft bottom. If a lashing unit is used, it is attached to the bottom of the stage.

Once everything is ready for blasting, the stage is withdrawn to a safe height. This stage movement could be anything between 70 m to 100 m. After blasting the stage is moved down again and finally positioned. The new position of the stage depends on the round length used during blasting, and is usually in the order of 3 m lower than the previous stage position.

Shaft sinking rates are generally between 1 000 m and 2 000 m per year.

Stage winder rope speeds are of the order of 0,6 m/s to 1 m/s. The stage winding speed depends on the number of falls per stage rope, and is in the order of 0,1 m/s to 0,25 m/s.

3. GENERAL DISCUSSION

3.1 STATUTORY REGULATIONS

New statutory regulations are currently in the process of being promulgated. These regulations will be referred to as the proposed regulations. The regulation that determines the strength of a stage rope is proposed Regulation 16.33, which reads:

A guide rope shall not be used in a winding system if the breaking strength at any point in such ropes is less than five times the effective combined weight of the rope and its tensioning weight. This provision shall not apply to any guide rope which is also used as a winding rope to raise or lower a stage, in which case the breaking force at any point in the rope shall not be less than 4,5 times the effective combined weight of the length of winding rope, and its share of the combined weight of the stage and attachments, the maximum permitted number of persons and the load of material.

The Dept. of Mineral and Energy Affairs said that the breaking force referred to in the above regulation is the initial breaking strength of the rope, and the static safety factor of 4,5 for a stage rope is therefore an installation factor.

Regulation 16.40 of the regulations currently in force requires a safety factor of 5 at discard for stage ropes, as opposed to the installation factor of 4,5 in the proposed regulations.

It will be shown in this report that the stage rope safety factor of 4,5 limits the shaft depth to around 2 500 m to 3 000 m. Deeper shafts will require lower factors.

3.2 STAGE ROPE LENGTH

Sinking stages require relatively long ropes because of the multiple falls of rope that have to be used to support the stage. At least eight rope falls will be required in a shaft to support a rationally sized stage in a deep shaft. One stage winder with two ropes would therefore require at least four falls per rope.

The longest non-spin rope that can be manufactured by Haggie Rand at present is a 43 mm diameter rope, 16 000 m long. The full 16 000 m of rope cannot be suspended in a shaft. Some rope length will be required from the take-up reel to the headgear, and for the height of the headgear itself. This will restrict the shaft depth to around 3 800 m. A 4 000 m deep shaft will therefore have to be sunk using two stage winders and four ropes.

3.3 ROPE TENSILE GRADE

At present, galvanised ropes can only be manufactured in tensile grades up to 1 900 MPa, as opposed to the 2 100 MPa of ordinary ropes. Galvanised ropes will have strengths of around 10% less than those of the highest tensile grade.

For a given same stage winder configuration, rope size and rope safety factor, some penalty on achievable shaft depth will be incurred if galvanised ropes have to be used. This is discussed further in section 5.

3.4 SHAFT ACCESS

It has to be assumed that future deep shafts could be sunk in areas where there are no other mines or shafts in the immediate vicinity. If such a shaft is to be the only means of access to the mine, the shaft size will most probably be in the order of 11 m diameter to enable the accommodation of a man winder, a rock winder, maybe a service winder, and a brattice wall to facilitate mine ventilation.

If adequate sinking rates are to be maintained at the deeper end of a deep shaft, the sinking operations may require two double drum kibble winders. Such a configuration may not be possible in a smaller diameter shaft.

The stage winder rope regulations for future deep shafts therefore will have to be such that the stage sizes required by large diameter shafts can be accommodated.

3.5 STAGE MASS

For a given rope size and rope safety factor, a lighter stage will allow greater depths to be achieved. In large diameter shafts, lighter (and therefore shorter) stages will limit the rate of sinking. Such a situation will not be viable if the reason for sinking a deep single lift shaft is that the time to full production has to be as short as possible.

Stage masses normally increase with the shaft diameter. Typical large stage masses for different shaft diameters are given in Table 1. The masses of stages for the shafts with diameters less than 11 m could be marginally heavier, but a 140 ton stage for an 11 m diameter shaft will give an adequate shaft sinking rate.

Table 1: Typical large stage masses

Shaft diameter	Stage mass (kg)
7 m	60 000
8 m	80 000
9 m	100 000
10 m	120 000
11 m	140 000

The rope regulations for deep shafts will have to be such that a 140 ton stage at 4 000 m will be allowed.

3.6 STAGE WINDERS

The total number of rope falls in a shaft determines what fraction of the weight of the stage will be supported by each rope fall. The final shaft depth determines the maximum length and weight of a stage rope fall. The sum of the weight of one rope fall and the fraction of the stage weight supported per rope fall determines the maximum "rope pull" required at the stage winder.

The larger stage winders that are available or in operation in this country were all designed to operate with ropes with diameters of 42 mm to 45 mm. The design capacity (maximum rope pull) of these winders are of the order of 250 kN to 290 kN. One exceptionally large stage winder was built for JCI and is currently in operation at the main shaft of Western Areas South Deep project. This winder has a rope pull capacity of 380 kN.

For a given stage mass, shaft depth and rope size, the rope pull at the stage winder can only be reduced by increasing the total number of rope falls in the shaft.

If future deep shafts have to be sunk with the equipment currently available, the achievable maximum shaft depths and the stage masses that can be supported will be limited by the capacity of these stage winders.

3.7 OTHER STAGE ROPE CONFIGURATIONS

Some alternative stage roping methods have been proposed in the past. One example is to have stage rope sheaves or terminations at an intermediate level in the shaft. Such a method will only reduce the total stage rope length, but will not reduce the stage rope forces at the headgear. The rope pull required by the stage winder and the rope safety factors will therefore not be affected. The cost and time delay to implement such a roping configurations will most probably also be greater than the cost saving on the stage rope length.

Counterweighing the stage through ropes and sheaves at an intermediate shaft level has been proposed as a method of reducing the rope forces. This has not yet been implemented at a sinking operation and could be quite an elaborate procedure. The implementation of such a procedure will also have its costs and time delays.

The most appropriate approach towards regulations for stage ropes that will allow the sinking of very deep shafts, is to consider the standard stage rope configurations only.

3.8 ROPE FACTORS OF OTHER INDUSTRIES

If another industry or operation used ropes at relatively low static factors, it would have been ideal if that experience could be used to motivate revised safety factors for stage ropes. This would only be viable if the rope constructions and sizes, rope operations and environmental conditions were comparable. Unfortunately, no other operation uses ropes in quite the same manner as stage winders.

Nevertheless, the (static) rope safety factors of crane ropes, track ropes, stay ropes, mooring ropes, aerial cableways, bridge standing ropes, structural ropes and guide ropes were investigated. Only rope factors lower than 4,5 were of interest. The following examples were found:

- Bridge ropes in the USA from *Standard Handbook for Civil Engineers* (p. 17-34):

In the United States the main cables are usually made up of 6-gage galvanized bridge wire of 220 to 225 ksi ultimate and 82 to 90 ksi working stress. The wires are placed either parallel or in strands and compacted and wrapped with No. 9 wire.

The above represents a safety factor of around 2,5.

- Structural ropes in the UK from *Steel Designers Manual* (p. 186):

Cable life is reduced by corrosion and fatigue. Galvanized cables under cover suffer very little corrosion; external cables properly protected should have a life of 50 years. Plastic sheathing has the great disadvantage of making

inspection of the cable impossible.

Fatigue investigations have shown that it is wise to limit the maximum tension in a cable to 40% of its ultimate strength for long-life structures. For structures with a design life of up to ten years a limit of 50% is acceptable. Flexing of the cables at clamps or end termination will cause rapid fatigue damage.

The above represents a safety factor of 2,5 for a long life and 2,0 for a 10 year life.

- Safety factors for crane ropes and ropes of aerial rope-ways from *SABS 0148-1979* (p. 7):

<i>c) cable crane track ropes</i>	<i>3,5</i>
<i>d) cable crane backstay ropes:</i>	<i>3,0</i>
<i>h) aerial rope-way standing track rope:</i>	<i>3,0</i>

Although the above factors are mentioned, quoted and allowed for various rope applications, actual rope factors used were difficult to obtain. However, if these factors are allowed there will be installations that actually utilise these relatively low factors. It is also notable that for the rope safety factors lower than 3 above, galvanised ropes are assumed or recommended.

In our own mining industry, a static rope safety factor of 3,125 at a depth of 4 000 m for a rope on a drum winder in a production shaft will be allowed by the proposed regulations⁶. Such an installation will have to comply with the requirements of a code of practice⁷. The lowest safety factor for a running rope on a mine shaft ever used in this country is 3,5. With special dispensation from the Dept. of Mineral and Energy Affairs, two ropes operate at this static safety factor on a double drum winder at a 2 200 m deep shaft at Elandsrand.

Although none of the above can directly be used as a motivation for revised factors for stage winders, it shows that for static load applications, rope safety factors of 3 and less are not uncommon.

4. STAGE ROPE FORCES AND DETERIORATION

4.1 STAGE ROPE FORCES

The stage rope forces measured during all types of sinking and stage operations, i.e. during blasting, lashing, stage raising and lowering, kibble crosshead interactions, and water hoisting, are described in three reports^{3,4,5}. These measurements were carried out during the first phase of the kibble and stage winder ropes investigation.

The peak-to-peak magnitudes of the dynamic components of the stage rope forces measured during any stage operation were never greater than 2% of the breaking strength of the ropes. The rope forces can therefore be regarded as static. It is most improbable that the rope load variations of stage ropes will contribute to rope deterioration.

Situations may arise that could cause rope forces greater than normal during stage winding. For example, if the stage hooks on to something in the shaft during stage withdrawal before blasting. If the rope force in such a case is allowed to exceed 40% to 50% of the breaking strength of the rope, inter-rope layer nicking in a non-spin rope could be detrimental to the fatigue resistance of this type of rope. However, the rope force variations in a stage rope is too small to cause crack initiation and growth. It is also unlikely that the stage winder will have enough pulling power to generate such large rope forces. Furthermore, the generation of excessive stage rope forces can be prevented by appropriate stipulations in a code of practice.

4.2 STAGE ROPE DETERIORATION

The deterioration mechanisms of stage ropes were described in some detail in a previous report². The main points are discussed in this section.

Accidental damage to the stage ropes is possible, but little more than avoiding such situations is possible. The normal deterioration of stage ropes will be caused by corrosion, the kibble guide rope function, and by the rope bending actions around sheaves during stage raising and lowering.

A sinking shaft gets progressively deeper. A section of rope therefore does not pass over all the components that can bend the rope during every stage hoisting cycle. In the worst case, any section of rope will at most experience some 1 000 rope bending cycles during the sinking of a shaft.

The drum and stage sheave diameter to stage rope diameter ratios (D/d ratios) are normally in the order of 45. The D/d ratio of the tensioner is normally smaller. The D/d ratios of drum winders are generally twice that of stage winders. Bending stresses in ropes have not been analysed extensively, but the combination of the axial rope load variations and bending stress of ropes operating on a normal drum winder could be of the same order of magnitude as the bending stress of a stage winder rope.

The number of bending stress cycles of a stage rope is far less than the number of winding cycles performed by a rope on a drum winder. Bending over sheaves and drums of stage ropes during sinking should therefore not present problems. Very little information is available on the presence of broken wires in stage ropes, and this is most probably so because of their absence. From past experience it can therefore be concluded that, if stage rope bending caused broken wires, it would have come to the attention of the industry.

The kibble guide rope function fulfilled by the stage ropes can lead to rope deterioration, but the indications are that the rope guide materials currently employed by the industry do not cause undue rope deterioration. Measures to prevent such deterioration on future deep shafts can, of course, also be included in a code of practice. Shallower shaft stage winder ropes also have to fulfil the guide rope function, but such operations will not have to comply with the requirements of a code of practice. The stage ropes of future deep stage winders will remain in service considerably longer than the ropes of shallower shafts. A requirement in a code of practice concerning the guide rope function therefore makes sense. A deep shaft operation that will ultimately have to comply with a code of practice, will have to implement the guide rope requirements from the start of the sinking operation.

The remaining contributor to stage rope deterioration is corrosion. The wetness of sinking shafts and the longer time that the ropes will be in operation in deep shafts can only increase the effect of corrosion. Apart from visual examination of the stage ropes, non-destructive testing of the ropes while in service is the sole means of determining the strength reduction of ropes due to corrosion.

If a shaft is 3 500 m deep and it has twelve falls of rope, the total length of the stage ropes in the shaft will be in excess of 40 km. The procedures for the non-destructive testing of stage ropes have not yet been defined⁸. Careful consideration is required to prevent the inspection of stage ropes becoming a time consuming and unpopular operation.

Corrosion can be prevented, or its effects reduced, by using galvanised winder ropes. Other methods of protection against corrosion, like cathodic protection, may also have merits.

4.3 ROPE SAFETY

The concepts of ensuring rope safety were dealt with in detail in a previous report². The basic fact is that a rope will not fail in service if the rope forces are smaller than the strength of the rope.

The stage rope safety factors of deep sinking shafts will have to be lower than those of the past, but stage ropes will only operate at and close to the minimum safety factor towards the end of the sink. The maximum forces in stage ropes are well known, are of a static nature, and are controllable. With the proper precautions, the deterioration of stage ropes can be limited to an absolute minimum. The integrity of stage ropes can further be ensured by proper rope condition monitoring at appropriate intervals. Relatively low safety factors for stage ropes are therefore in order.

Accidental damage may in the worst case lead to failure of one stage rope. The effects of such situations will be discussed further on in this report.

5. STAGE ROPE SAFETY FACTORS

Shaft depths, stage rope safety factors and the required capacity of stage winders are discussed in this section. It was mentioned earlier in this report that the rope regulations for future deep shafts have to provide for the use of large stages. Stage masses of 120 tons to 140 tons are therefore considered in this section.

At present the most popular stage winder rope size is of the order of 42 mm to 45 mm for the larger stage winders. The 16 000 m rope that can be manufactured by Haggie Rand has a diameter of 43 mm. The large JCI stage winder mentioned before, was designed to operate with a 43 mm rope.

The combinations of rope sizes, stage masses and final shaft depths give numerous possibilities. In order to simplify the analysis that follow, two ropes will be used in the example calculations:

43 mm, 1 900 MPa galvanised rope of 8,4 kg/m and strength of 1 500 kN.

43 mm, 2 100 MPa rope, also of 8,4 kg/m and strength of 1 640 kN.

The shaft depths achievable under the proposed stage rope safety factor of 4,5 and various stage masses are shown in Table 2. The total rope length of one stage rope was calculated as the sum of the lengths of the rope falls in the shaft plus an extra 5%. The maximum stage winder capacity is the maximum value of the "rope pull" required at the stage winder, and has to be equal to the rope strength divided by the safety factor.

Table 2: Shaft depths achievable with a safety factor of 4,5 and a 43 mm diameter rope.

Rope falls	Stage mass (kg)	Rope tensile grade (MPa)	Maximum shaft depth (m)	Total length of one rope (m)	Maximum stage winder capacity (kN)
2 ropes and 4 falls per rope	140 000	2 100	2 340	9 830	365
		1 900	1 970	8 270	335
	120 000	2 100	2 640	11 090	365
		1 900	2 260	9 490	335
	100 000	2 100	2 940	12 350	365
		1 900	2 560	10 750	335
2 ropes and 5 falls per rope	140 000	2 100	2 760	14 490	365
		1 900	2 380	12 500	335
	120 000	2 100	3 000	15 750	365
		1 900	2 620	13 750	335
	100 000	2 100	3 230	16 960	365
		1 900	2 860	15 020	335
4 ropes and 3 falls per rope	140 000	2 100	3 040	9 580	365
		1 900	2 660	8 380	335
	120 000	2 100	3 240	10 200	365
		1 900	2 860	9 010	335
	100 000	2 100	3 430	10 810	365
		1 900	3 050	9 610	335

Table 2 shows that with two stage ropes, the shaft depths achievable with the proposed safety factor of 4,5 can be as deep as 3 000 m for a 120 ton stage before the mentioned rope length limit of 16 000 m is reached. The shaft depths of the 2 100 MPa ropes are of the order of 350 m greater than that of the 1 900 MPa galvanized ropes.

Increasing the number of rope falls in the shaft from 8 to 10 gives an extra shaft depth of 360 m on average. Going from 10 to 12 falls adds, on average, a further 240 m shaft depth. For the shaft depths of Table 2, 12 rope falls will require four stage ropes to be used.

Table 2 further shows that the rope pull required by the various configurations is beyond that of most stage winders currently available. (The stage winder at Vaal Reefs 11 Shaft³ had a nominal capacity of 290 kN, but was finally used at rope forces of around 335 kN because of an increased stage mass. The limit of that winder was not the power of the motor, but the strength and construction of the stage winder.)

Table 3 shows what shaft depths can be achieved with two stage ropes and a minimum of four falls per rope. Here the limiting factor is the maximum length of rope that can be manufactured by Haggie Rand, which is 16 000 m.

Table 3: Safety factors required and maximum shaft depths achievable with two stage ropes of 43 mm diameter.

Rope falls	Stage mass (kg)	Rope tensile grade (MPa)	Maximum shaft depth (m)	Minimum safety factor	Total length of one rope (m)	Maximum stage winder capacity (kN)
2 ropes and 4 falls per rope	140 000	2 100	3 800	3,38	15 960	485
		1 900		3,10		485
	120 000	2 100		3,57		460
		1 900		3,26		460
	100 000	2 100		3,77		435
		1 900		3,45		435
2 ropes and 5 falls per rope	140 000	2 100	3 000	4,27	15 750	385
		1 900		3,90		385
	120 000	2 100		4,50		365
		1 900		4,11		365
	100 000	2 100		4,75		345
		1 900		4,35		345

Table 3 shows that a depth of 3 800 m can be achieved with two ropes and four falls per rope. A safety factor of just more than 3 will be required if a heavy stage is used with galvanized ropes. Again the required pulling capacity of the stage winders will be beyond what is currently available.

If eight rope falls are required in a shaft to provide guides for four kibles, a depth of 4 000 m can currently only be achieved if four stage ropes are used. This will require two stage winders. Table 4 shows some examples.

Table 4: Safety factors required for a maximum shaft depth of 4 000 m using 4 stage ropes of 43 mm diameter.

Rope falls	Stage mass (kg)	Rope tensile grade (MPa)	Maximum shaft depth (m)	Minimum safety factor	Total length of one rope (m)	Maximum stage winder capacity (kN)
4 ropes and 2 falls per rope	140 000	2 100	4 000	3,27	8 400	500
		1 900		3,00		500
	120 000	2 100		3,44		480
		1 900		3,15		480
		100 000		2 100		3,63
1 900	3,32		450			
4 ropes and 3 falls per rope	140 000	2 100	4 000	3,70	12 600	445
		1 900		3,38		445
	120 000	2 100		3,84		430
		1 900		3,51		430
		100 000		2 100		3,99
1 900	3,65		410			

Table 4 shows that a safety factor of 3 will allow a 140 ton stage to be supported by eight falls of galvanised rope at a shaft depth of 4 000 m.

On the grounds of the deliberations in section 3.8 and section 4.3 of this report, a stage rope safety factor of 3 is acceptable for stage winder ropes. Operations that will make use of this safety factor, in stead of the 4,5 of the proposed regulations, will have to comply with the requirements of a code of practice.

Table 2 showed that considerable shaft depths can be achieved before the "normal" stage rope safety factor of 4,5 is reached. It may be reasoned that, until that depth is reached, the operation is no different to that of a shaft that will only be sunk to a depth that will not require compliance with the requirements of a code of practice. The code of practice therefore will have to specify what requirements have to be complied with from the start of the sinking operations, and what is required additionally in order to "switch over" from a normal sinking operation to one that complies with the code of practice.

A stage rope safety factor of 3 presents numerous other possible stage winder rope configurations for smaller shafts with lighter stages. With this factor, a smaller diameter shaft with a stage of 70 tons to 80 tons can be sunk to 4 000 m using one stage winder with two ropes and two or three falls per rope.

Lastly: At 4 000 m, the weight of one rope fall of 8,4 kg/m is already 330 kN. Increasing the number of rope falls or using a smaller and lighter stages will not change this value. The weight of a 4 000 m length of rope alone is beyond the capacity of most stage winders currently available in this country. The sinking of very deep shafts will require the design and manufacture of new stage winders.

6. ROPE FAILURE

Load equalisation between stage ropes is normally done manually. It is therefore possible for one stage rope to carry less of the stage load. In the worst case the one stage rope will not carry any load. An example of such an event is when a take-up reel loses its braking effort. If the rope holding force is less than that produced by the tensioning weight, the tensioning weight will move to its lowest position, and will not supply adequate rope force on the take-up reel side of the friction winder. The rope will then be dragged through the friction winder, and the stage will only be supported by the remaining stage rope(s). Although such incidents can be prevented by adequate precautions, the question remains of what will happen if such an event occurs in any case.

A 140 ton stage, supported by two stage ropes and eight rope falls in total, will give a safety factor of 4,5 at a depth of 1 970 m if the rope strength is 1 500 kN. If one stage rope slips, the maximum rope force in the remaining rope will increase from 22 % of the rope strength to 34 %. At a depth of 4 000 m the rope safety factor will be 3,0 for the same winder configuration. If one stage rope slips at this depth, the maximum rope force in the remaining stage rope will increase from 33 % of the rope breaking strength to 45 %. A maximum rope force of 45 % of the breaking strength of a stage rope is acceptable for an event that should not be allowed to occur.

It has been reported that a stage rope fracture had once occurred at the rope tensioner of a friction winder. Apparently a malfunction on one take-up reel during stage lowering caused the sheave of the tensioning weight to be pulled up to its highest physical position. When this sheave made contact with the other two sheaves in the tensioner, the rope fractured. The occurrence of such an incident can be prevented by designing the layout of the tensioner properly, and not by the specification of rope safety factors.

The shaft sinking environment is such that the possibility of an accidental stage rope fracture in the shaft might not be excludable altogether. Irrespective whether accidental rope failure could occur or not, the rope forces in the remaining stage rope(s) generated by such an event were analysed. The purpose was to determine whether the consequences of a stage rope failure would be even worse if a stage rope safety factor of 3 was used in stead of 4,5.

It is not easy to visualise what will happen to the rest of a stage rope after a fracture occurred. Thus, for the purposes of this analysis, only one possible scenario was considered. It was assumed that a rope fracture would occur near the headgear, and that two falls of rope would drop onto the stage. If a stage rope only has two falls in the shaft, only one fall of rope can drop onto the stage. It was further assumed that the ropes would be able to fall unrestricted through the shaft. This would require no interference from the kibbles that use the stage ropes as guides.

The following assumptions were made for the calculation of the rope forces:

- 43 mm diameter 8,4 kg/m rope, 1 900 MPa tensile grade, and a strength of 1 500 kN.
- The remaining load carrying rope(s) did not slip on the stage winder(s).
- The rope impact with the stage was inelastic and momentum was conserved.
- The rope(s) behaved elastically, i.e. plastic deformation not included.

The numerical method used in the rope force calculations was basically the same as the one previously used¹. A constant rope elastic modulus of 125 GPa was used. The falling ropes were divided up into 200 sections, and accelerated under gravity. In a 4 000 m shaft the last section

of rope will have a (theoretical) speed of just more than 1 000 km/h when it reaches the stage.

The rope forces shown in Fig. 2 are for a single stage winder with two ropes and five falls per rope. The stage mass was 130 tons and the suspended rope length 2 500 m. The rope safety factor of 4,5 is the minimum value for stage ropes allowed under the proposed regulations. Two rope falls were allowed to drop onto the stage. After failure of one stage rope, the stage was supported by the five falls of the remaining rope. The highest rope force will occur at the top end of the shaft in the vicinity of the headgear, and is marked "back" in Fig. 2. The rope force at the stage ends of the rope is marked "front". The rope force in the remaining stage rope reached a value of nearly 50% of the (new) breaking strength of the rope as opposed to the 22% before rope failure occurred.

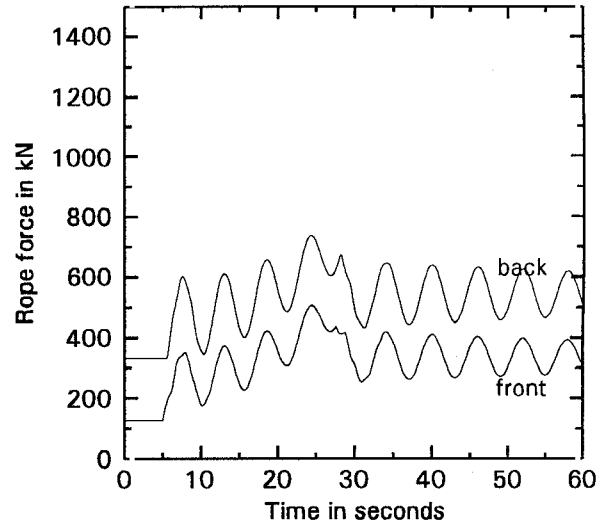

Figure 2: Two ropes, 5 falls per rope, 2 500 m deep, 2 falls drop onto the stage.

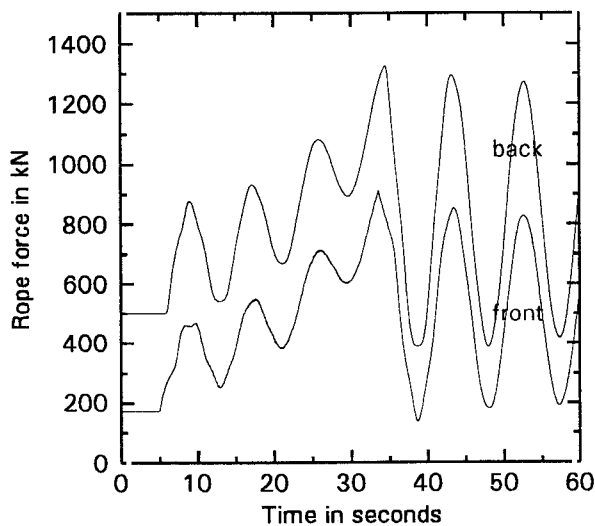

Figure 3: Two ropes, 4 falls per rope, 4 000 m deep, 2 falls drop onto the stage.

The winder configuration of Fig. 3 is two ropes and four falls per rope. A stage mass of 140 tons and the suspended rope length of 4 000 m gave a safety factor of 3,0. In this case the total rope length required for each rope will be greater than what is currently available. After a rope failure the stage was supported by the four falls of the remaining rope. Two rope falls were allowed to drop onto the stage. The maximum rope force was 88% of the breaking strength of the rope. The value corresponding to a safety factor of 3,0 is 33%.

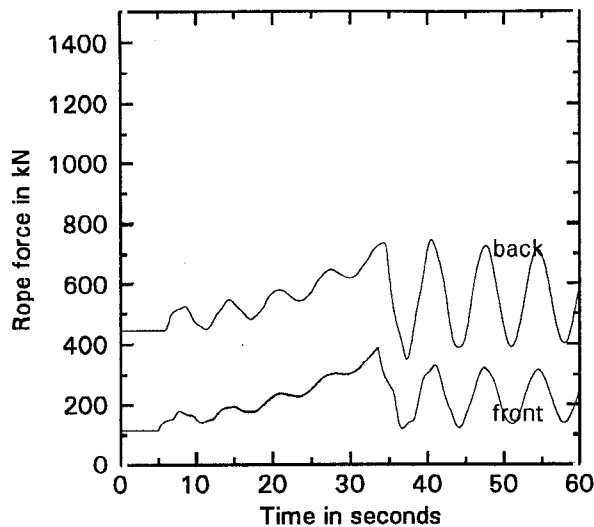

Figure 4: Four ropes, 3 falls per rope, 4 000 m deep, 2 falls drop onto the stage.

Two stage winders with four ropes in total were used for the calculations shown in Fig. 5. In this case, only two falls per rope were used, which gave eight falls in total. With a stage mass of 140 tons and a suspended rope length of 4 000 m, the rope safety factor of 3,0 is the same as that of Fig. 3. With only two falls of rope per stage rope, rope failure can at most drop one rope fall onto the stage. The stage is then still supported by the six falls of the remaining three ropes. The maximum rope force was just less than 50% of the breaking strength of the rope.

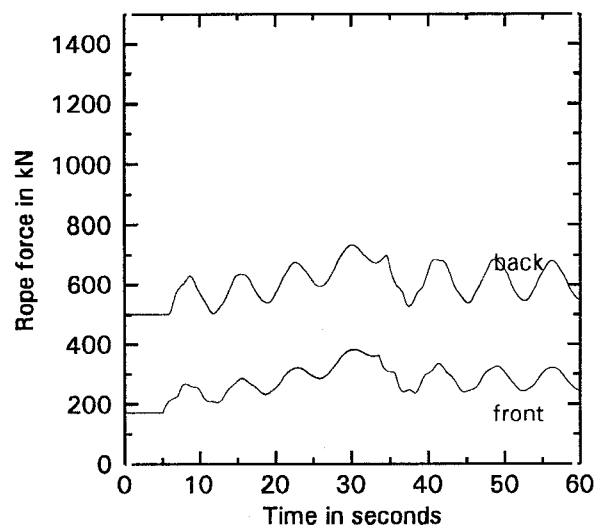

Figure 5: Four ropes, 2 falls per rope, 4 000 m deep, one fall drops onto the stage.

Although the assumptions for the analysis in this section were somewhat unrealistic, the results do show that certain stage winder configurations have advantages. If the possibility of a stage rope failure has to be considered, four stage ropes with only two falls per rope would be the better configuration.

For a rope safety factor of 3, the stage ropes can be configured such that the consequences of a stage rope failure will not be worse than when a stage rope safety factor of 4,5 is used.

7. CONCLUSIONS AND RECOMMENDATIONS

A minimum safety factor for stage ropes of 3 is required to be able to sink shafts to depths of 4 000 m. Stage ropes will only reach this minimum value towards the end of the sinking operations. A stage rope safety factor of 3 is acceptable and recommended because:

- The deterioration of stage ropes can be limited to a minimum.
- The forces that can be generated in stage ropes during normal sinking operations are basically of a static nature and very predictable.

From the depth at which the safety factor of the stage ropes equals 4,5 the stage winder will have to comply with the requirements of a code of practice.

Ensuing from this report, the following have to be considered for inclusion in the code of practice for stage winder and stage ropes:

- Kibble guide materials, operation, and replacement.
- Stage rope force monitoring.
- The use of galvanised ropes or other means of protection against rope corrosion.
- D/d ratios for the stage winder drum and stage rope sheaves.
- For friction winders: Drum coiling and shape specifications, friction coefficients, minimum tensioning weights, layout of the tensioner, and take-up reel braking.
- For stage hoists with the full length of rope coiled onto the drum: Tensioning of the rope on the drum.
- Rope end termination specifications.
- The requirements that have to be complied with from the start of the sinking operations, and the requirements when an existing sinking operation wants to use stage rope safety factors of less than 4,5.

The procedures for the non-destructive testing of stage ropes and the testing intervals should be part of the rope condition assessment code of practice⁸. Rope maintenance procedures could be part of the code of practice for sinking winders.

New stage winders will have to be designed and manufactured for the sinking of deep shafts because of the high rope forces that will be produced. If four stage ropes are used, only two falls per rope will be required in a 4 000 m deep shaft. The total rope length of each rope will then be around 8 500 m. All different stage winder configurations should be considered for the new designs in order to minimise the possibility of occurrence of abnormal incidents.

In the current and proposed regulations, the strength of stage winder ropes are specified as a secondary part of the guide rope strength regulation. Consideration should be given to a separate regulation for the strength of stage winder ropes, and then stating explicitly that the rope factors are to be calculated on the new rope breaking strength. The recommended stage rope safety factor of 3, for stage winders that comply with the requirements of a code of practice, can then form part of this regulation.

8. REFERENCES

1. Van Zyl, Mike: *Load ranges acting in kibble winder ropes and proposals for new kibble winder rope regulations.*
CSIR Contract Report MC3127, No. 960348, November 1996.
2. Van Zyl, Mike: *Overview of the winding rope requirements for deep shaft sinking operations.*
CSIR Contract Report MC2736, No. 950373, April 1996.
3. Van Zyl, Mike: *Rope force measurements during shaft sinking operations at Vaal Reefs 11 Shaft.*
CSIR Contract Report No. 950373, December 1995.
4. Van Zyl, Mike: *Rope force measurements during shaft sinking operations at West Driefontein 10 Shaft.*
CSIR Contract Report No. 960374, January 1996.
5. Van Zyl, Mike: *Rope force measurements during shaft sinking operations at West Driefontein 9 Shaft.*
CSIR Contract Report No. 960375, February 1996.
6. Hecker, G F K: *Motivation for proposed changes to Chapter 16 of the Minerals Act; Rope safety regulations for drum winders.*
CSIR Contract Report MST(92)MC1674, June 1993.
7. SABS xxxx:199x: South African Standard: *Code of practice: Mine winding ropes and plant.* (Draft safety standard for the performance, operation, maintenance and testing of mine winding plant.)
8. SABS xxxx:199x: South African Standard: *Code of practice: Condition of steel wire ropes on mine winders.*

Appendix CC: Load ranges acting in kibble winder ropes and proposals for new kibble winder rope regulations

CONTENTS

	Page
1. INTRODUCTION	1
2. DEFINITIONS	2
3. WINDER DYNAMICS	3
4. KIBBLE WINDER ROPE LOADS	4
4.1 KIBBLE WINDER ACTIONS	4
4.2 ROPE FORCES DURING KIBBLE WINDING CYCLES	5
4.2.1 A rock hoisting cycle	5
4.2.2 Conveying the jumbo drilling rig	6
4.2.3 Other conveying cycles	8
5. THEORETICAL ANALYSIS OF LOAD RANGE	9
5.1 THE CALCULATION OF LOAD RANGE	9
5.2 LOAD RANGE RATIO	10
5.2.1 Load range in terms of the safety factor	10
5.2.2 A formula for kibble winder safety factors	11
5.2.3 Load range in terms of the capacity factor	13
5.2.4 Load range in terms of the capacity factor and safety factor	17
6. PROPOSED REGULATIONS FOR KIBBLE WINDER ROPES	18
6.1 THE PURPOSE OF WINDER ROPE REGULATIONS	18
6.2 THE FORM OF KIBBLE WINDER REGULATIONS	18
6.3 A LOGICAL APPROACH TOWARDS NEW REGULATIONS	19
6.4 ANALYSIS OF THE CAPACITY FACTOR APPROACH	19
6.4.1 Shaft depth less than the transition depth	19
6.4.2 Beyond the transition depth	21
6.5 CHANGES REQUIRED TO THE REGULATIONS	23

7.	LOAD RANGE FROM ROPE FORCE MEASUREMENTS	24
7.1	ROPE FORCE MEASUREMENTS	24
7.2	PRACTICAL LOAD RANGE DETERMINATION	24
8.	CONCLUSIONS AND RECOMMENDATIONS	25
9.	REFERENCES	26
	APPENDIX A: PROPOSED REGULATIONS FOR DRUM WINDER ROPES	27
	APPENDIX B: WINDER ROPE DYNAMICS	28
B1.	ROPE FORCE CALCULATION MODEL	28
B2.	GENERAL BEHAVIOUR	29
B3.	CHANGING THE WINDER PARAMETERS	31
B3.1	Stiffness and acceleration	31
B3.2	Rope length and attached mass	33
B3.3	Changing the rope size and properties	36
B3.4	Changing gravitational acceleration	36
B3.5	Ramped acceleration	36
B4.	SUMMARY	39
	APPENDIX C: MASS AND STRENGTH OF NON-SPIN ROPES	40
C1.	CROSS-SECTIONAL STEEL AREA	40
C2.	ROPE MASS	40
C3.	ROPE STRENGTH	41
C4.	EXAMPLE CALCULATIONS	41
	APPENDIX D: SAFETY FACTOR AND EMERGENCY BRAKING	42
	APPENDIX E: FURTHER APPROXIMATIONS OF THE SHAPE OF KIBBLE WINDER SAFETY FACTORS	44
	APPENDIX F: LOAD RANGE FROM MEASURED ROPE FORCES	48
F1.	WINDER AND ROPE DATA	48
F2.	RESULTS OF LOAD RANGE RATIO CALCULATIONS	48
F2.1	Vaal Reefs 11 Shaft	49
F2.2	West Driefontein 10 Shaft	49
F2.3	West Driefontein 9 Shaft	49

1. INTRODUCTION

The regulations governing the strength of ropes for stage and kibble winders are being investigated under the auspices of a SIMGAP Engineering Advisory Group. The object of the investigation is to draft regulations and codes of practice that will allow safe sinking operations with stages and kibbles to depths of 4 000 m.

Rope factors and rope force limits that will allow permanent drum winder installations to operate to such depths have already been proposed¹. From these proposals, the Department of Mineral and Energy Affairs drew up the regulations for drum winder ropes given in Appendix A. The first part of these regulations require a rope to have a *capacity factor* of 8,0 and a *safety factor* of 4,5. Deep winds will require rope factors lower than these. To allow such winds a *safety factor formula* was derived¹, which require the safety factor to be equal or greater than $25\,000 / (4\,000 + L)$ with L the maximum length of suspended rope in metres. Winders that make use of the *safety factor formula* will have to comply with the requirements of a code of practice².

The derivation of the *safety factor formula* was based on restricting the *dynamic load range* of a winder rope to 15% of the breaking strength of the rope under a given set of winder and operational conditions. The winder code of practice², amongst other things, require that this level for the load range be determined and maintained.

A report, *Overview of the winding rope requirements for deep shaft sinking operations*,³ discussed the applicability of the *safety factor formula* and the *winder code of practice* to kibble winder ropes and kibble winder installations. That report concluded that a separate code of practice, which will include both kibble winders and stage winders, will have to be drawn up. It also concluded that the *safety factor formula* was not applicable to kibble winders because of expected differences in load range for the same rope safety factors. Furthermore, the depth of a sinking shaft increases progressively, while the winding depth of a permanent winding installation is fixed. A safety factor is shaft depth related and may therefore not be the appropriate solution for the factors required for the ropes of kibble winders.

Limiting and controlling the rate of deterioration of a winder rope enhances safety, because the strength of a rope will then not decrease excessively between major rope inspections. It has not been proven that load range exclusively determines the life and performance of a winder rope, but it is known that load range governs both the *backslip* of a drum winder rope as well as the tensile load variation during a winding cycle. *Backslip* contributes to the deterioration of the outer rope surface, and the tensile load variation contributes towards crack initiation, crack propagation, and ultimately the generation of broken wires.

The reasons for, and merits of, a 15% load range ratio fall outside the scope of this report. However, it is only rational that the regulations for the strength of kibble winder ropes be based on this same rope load range ratio.

In this report, the load ranges of kibble winder ropes are analysed to obtain a basis for regulations that will allow the sinking of deep shafts with kibble winders. From this analysis, regulations for kibble winders are proposed, both for installations that will have to, and will not have to, comply with the requirements of a code of practice. The load ranges that were calculated from the rope forces measured at three sinking installations^{4,5,6} are also shown in this report.

2. DEFINITIONS

Some of the terms used in this report are defined as follows:

Front end: That end of the rope attached to the kibble, or the section of rope near the kibble end of the rope.

Back end: That end of the rope at or near the drum when the kibble is at its lowest position in the shaft. As a shaft gets deeper, the back end position on the rope changes.

Initial breaking strength: The actual breaking strength of a rope when new. Also called the new rope breaking strength.

Capacity factor: The initial strength of the rope divided by the maximum static load it has to support at its front end.

Safety factor: The initial strength of the rope divided by the maximum static load it has to carry (i.e. the maximum weight that it has to support at its front end plus the weight of the maximum length of the suspended rope). This factor decreases for kibble winder ropes as the depth of the shaft increases.

Winding cycle: A winding cycle is a round or intermittent trip, starting with the one conveyance (or rope front end or crosshead), say the right hand side, at bank level and ending with the same conveyance returning to the bank level.

Load range: This is the difference between the largest and smallest force that occurred in a given section of rope during one complete winding cycle. When the static rope forces are used to determine the load range it will be referred to as the *static load range*, and when actual rope forces are used it will be referred to as the *dynamic load range* or just the *load range*.

Load range ratio: This refers to the *load range* expressed as a percentage or fraction of the initial breaking strength of a rope.

Permanent installations: Permanent installations refer to those winding systems that operate in shafts after sinking and equipping of a shaft have been completed.

Permanent winder: The drum winders of a permanent installation.

Sinking installations: This term refers to those winding systems used for shaft sinking.

Kibble winder: The drum winder used for kibble winding during shaft sinking operations. Although this winder is often the permanent winder, the term "kibble winder" is used to distinguish between the operations of a winder and its ropes during shaft sinking operations and their use at a permanent installation.

Backslip: After a load was conveyed from shaft bottom, off-loaded at the top, and the empty conveyance returned to shaft bottom, any section of the rope would have been wound onto the drum at a higher tension than it would be unwound at. The higher rope tension is "locked-in" on the drum through friction, and equilibrium during unwinding of the rope is only effected during the last half to full drum turn before a section of rope leaves the drum. To accommodate the difference in rope elongation between the winding up and winding down rope tensions, the rope slips back on the drum during the time that equilibrium is achieved. This action is referred to as *backslip*. When the load during a descending trip is greater than during the preceding ascending trip, backslip will be in the opposite direction, i.e. towards the front end of the rope.

3. WINDER DYNAMICS

The dynamic response of a rope-mass system has to be known to be able to evaluate the rope forces generated when a winding rope with a given attached mass is accelerated or decelerated. The dynamic component of the load range of a winding rope is determined by this response.

Rope dynamics are analysed in detail Appendix B, p. 28. That appendix shows that the maximum rope force generated when a winder with a rope and attached mass is accelerated upwards (or decelerated while the conveyance descends) is:

$$Force = mass [g + a(1 + \alpha)] \quad (1)$$

with: $mass$ = suspended mass
 g = gravitational acceleration
 a = value of a constant acceleration at the drum end
 α = dynamic (amplification) factor

The suspended mass in Eqn 1 is the total mass below the point on the rope at which the rope forces are to be calculated.

The dynamic factors for different rope sections were calculated in Appendix B and are:

$$\begin{aligned} \alpha_{back} &= 0,80 \\ \alpha_{middle} &= 0,95 \\ \alpha_{front} &= 1,05 \end{aligned}$$

"Back" refers to the back end or drum end of the rope, "middle" to the section halfway between the back end and the front end of the rope, and "front" to the kibble end or front end of the rope.

The acceleration of the winder can be "ramped" with modern winder control systems. Appendix B also shows that the values of the dynamic factors can be reduced, and even eliminated, if appropriate ramp times are used.

4. KIBBLE WINDER ROPE LOADS

4.1 KIBBLE WINDER ACTIONS

The kibble winder normally performs the following conveying duties:

- Men and material in a kibble both down and up the shaft.
- Rock to the surface.
- The "jumbo" drilling rig down and up.
- Water in a kibble to the surface.
- Various items slung from the front end of the rope.

The front end of the rope is guided by a crosshead that uses the stage winder ropes as guides. The rope can be wound down and up the shaft with the crosshead as the only attachment to the front end of the rope. When the front end of the rope descends through the stage near shaft bottom, the crosshead is left behind on top of the stage. It is picked up again after the front end of the rope has ascended through the stage.

The only other time that the crosshead is separated from the front end of the rope is during tipping of a kibble load. For tipping of a kibble load, the kibble is moved to just above the tipping position. Chains are then attached to the bottom of the kibble to enable the tipping action. The crosshead is held in position while the winder lowers the front end of the rope through the crosshead to tip the load. It can be assumed that all load is totally released at the front end of the rope during tipping.

The majority of all kibble winder cycles are for rock hoisting. A typical rock hoisting cycle proceeds as follows: The kibble load is tipped, the crosshead is picked up, and the empty kibble descends out of the tip. The winder (with the empty kibble and crosshead at the front end of the rope) is then accelerated to maximum winding speed. The winding speed is maintained to near shaft bottom where the winder is decelerated to creep speed. The crosshead is left behind on top of the stage, the empty kibble is placed on the shaft bottom and the rope removed from the kibble. Another full kibble is then hooked to the rope, lifted, and hoisted through the stage. At the top of the stage the crosshead is lifted and the winder (with the full kibble and crosshead attached to the front end of the rope) is accelerated to maximum winding speed. At the top the winder is decelerated to creep speed and the kibble positioned in the tip. The kibble is then tipped to start another rock hoisting cycle.

Water hoisting with a kibble normally proceeds as follows: A kibble, suspended at the end of the rope, is positioned in the stage and pumped full of water. The kibble then ascends through the stage, the crosshead is picked up, and the winder is accelerated to maximum winding speed. At the top, the winder is decelerated and the kibble is positioned at the tip and the water is pumped out of the kibble. The empty kibble is then wound down to the stage again. Sometimes the kibble is also tipped after the water was pumped out.

The conveying of men, material, jumbos and other items are all done from bank level to either the stage or shaft bottom, and vice versa.

4.2 ROPE FORCES DURING KIBBLE WINDING CYCLES

The rope forces that are generated during some kibble winder cycles are analysed in this section. In order to give the rope forces realistic values, the following winder and rope parameters were selected:

Maximum length of suspended rope	2 000 m
Rope diameter	47 mm
Rope mass	10 kg/m
Crosshead mass	1 500 kg
Kibble mass	4 500 kg
Rock mass	14 000 kg
Jumbo drilling rig mass	20 000 kg
Normal winding:	
constant acceleration	1 m/s ²
constant deceleration	1 m/s ²

4.2.1 A rock hoisting cycle

A schematic of the rope forces generated during a rock hoisting cycle is shown in Fig. 1 below. The figure shows both the back end (or rather near back end) rope force (higher values) and the front end rope force (lower values).

The cycle starts with the empty kibble descending. During most of the descending trip, the back end of the rope is still on the drum (indicated by the dashed line). When the back end of the rope is wound off the drum, backslip occurs. The deceleration of the rope and attached mass near the stage causes an increase in rope force plus some rope dynamics. The end of the deceleration period generates some more rope dynamics.

Leaving the crosshead on top of the stage and placing of the kibble on the shaft bottom further decrease the rope forces. The mass of the chains at the end of the rope is neglected. At this point the only rope loads are those from the suspended length of rope, therefore zero load at the front end of the rope. The kibble with its full rock load is then lifted. Actual measurements of the rope forces during such an event^{5,6} showed that the rope dynamics associated with this event is negligible provided that the lifting speed is slow. The crosshead is then picked up when the kibble ascends through the top of the stage, and the winder accelerates the rope and the attached load.

The back end of the rope is wound onto the drum and the rope forces are "locked-in". At the end of the ascending trip, the winder is decelerated and it creeps into the tip. The crosshead is then held while the kibble is tipped, again resulting in a zero load at the front end of the rope. After the crosshead is picked up, the winder accelerates to maximum winding speed, completing the rock hoisting cycle.

The static load range, i.e. disregarding acceleration/deceleration forces and rope dynamics, for any part of the rope is the same, and equal to the weight of the kibble, crosshead, and the rock load.

The largest dynamic rope force, for any section of rope, is generated when the largest static load is accelerated at (or near) shaft bottom. Because the back end of the rope has to support a greater mass than the front end, the dynamic rope forces during winder acceleration (see section 3) will be greater at the back end than at the front end. This is indicated as such in Fig. 1. The dynamic

component of the rope force for any section of rope between the front and the back end will lie somewhere between the back end and front end values.

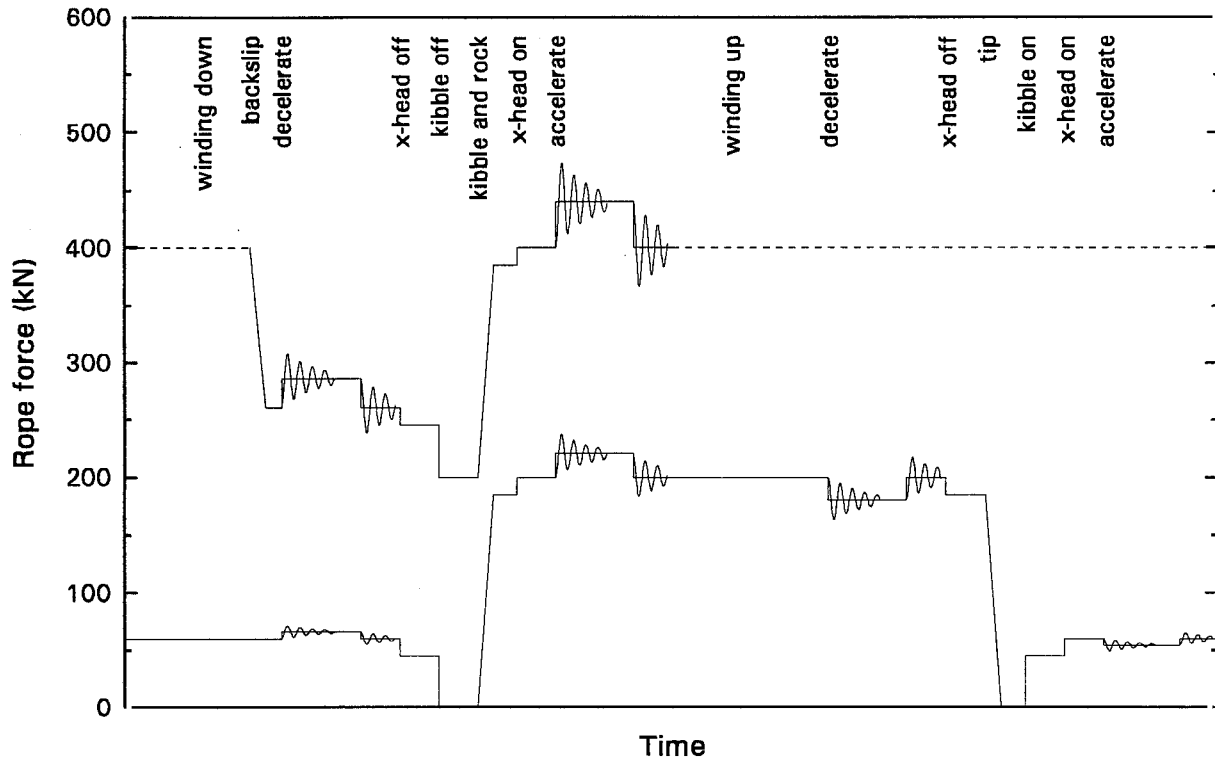

Figure 1: Schematic of the rope forces at the front end and back end of a rope during a rock hoisting cycle of a kibble winder.

Inspection of Fig. 1 above shows that the minimum front end load is zero during a rock winding cycle. The dynamic load range at the front end of the rope during the rock winding cycle is therefore equal to the maximum rope load that occurred at the front end during such a cycle. The front end rope force actually reaches zero load (the minimum load) twice during the rock winding cycle. The distinct load range during the "winding down" trip (between two zero loads) is, however, not significant compared to that of the "winding up" trip.

Inspection of Fig. 1 further shows that the minimum back end rope load was equal to the (static) weight of the maximum length of suspended rope. The dynamic load range at the back end of the rope during the rock winding cycle is therefore equal to the maximum rope load that occurred at the back end during such a cycle, minus the weight of the maximum length of suspended rope.

It can therefore be concluded that the load range for any part of the rope during a rock winding cycle is equal to the maximum rope load that occurred in that part of the rope minus the weight of the rope below that point. The largest load range during a rock hoisting cycle occurs at the back end of the rope.

4.2.2 Conveying the jumbo drilling rig

A schematic of the rope forces generated in a winding cycle during which a jumbo drilling rig was conveyed from the bank to shaft bottom is shown in Fig. 2 below. The figure shows both the back end and the front end rope force.

It was assumed that during the trip before the jumbo cycle, an empty kibble was brought to the bank. The value of the backslip is determined by this. In this case the backslip is actually in the forward direction. It was further assumed that after the jumbo was placed at shaft bottom, only the crosshead was attached to the rope during the reverse trip.

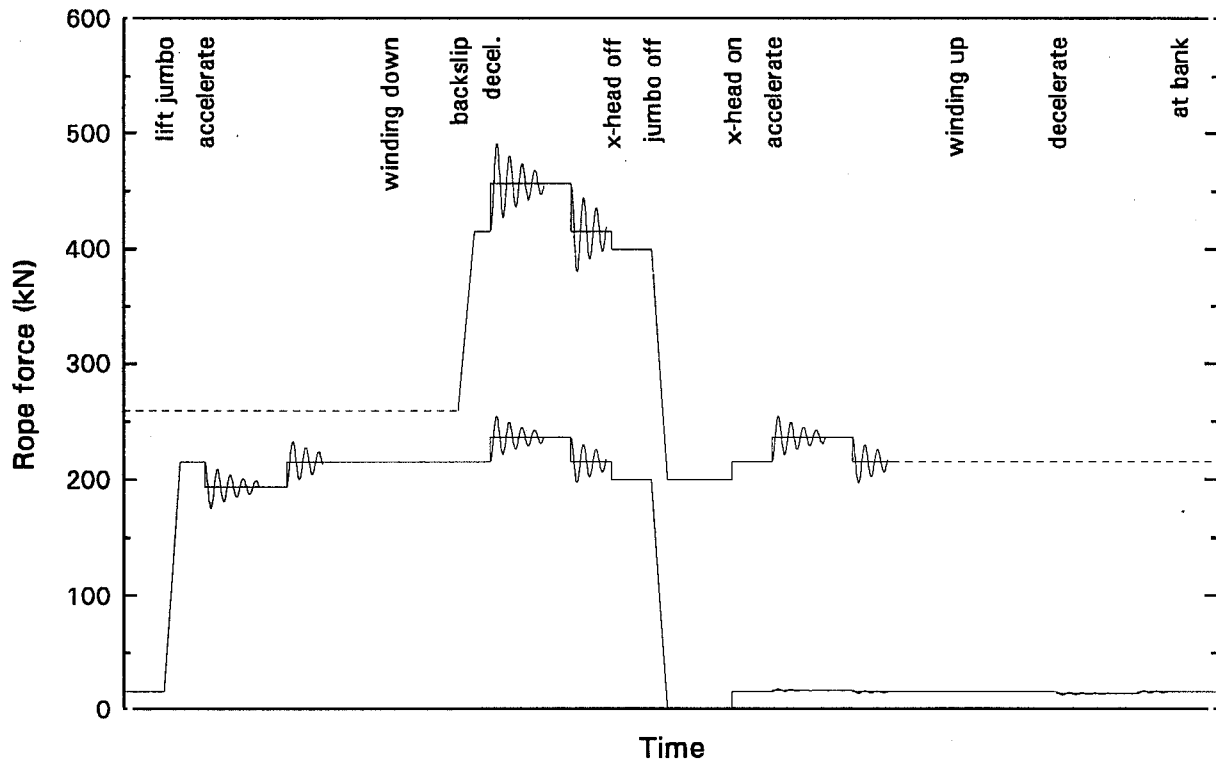

Figure 2: Schematic of the rope forces at the front end and back end of a rope during conveying of a jumbo drilling rig to shaft bottom.

Actual measurements of the rope forces during lifting of the jumbo drilling rig^{5,6} showed that, as was the case for lifting a loaded kibble, the rope dynamics associated with this event is negligible provided that the lifting speed is slow. The rest of Fig. 2 can be interpreted in the same way as described for the rock winding cycle in the preceding section.

A schematic of the rope forces generated by taking down the crosshead only and bringing back the jumbo is shown Fig. 3 below. The figure again shows both the back end and the front end rope forces. It was assumed that during the last trip before this cycle, an empty kibble was brought to the bank.

As for a rock hoisting cycle, the largest rope forces, for any section of rope, are generated when the largest static load is accelerated and decelerated at (or near) shaft bottom.

Figures 2 and 3 show that the minimum front end load was zero during both jumbo conveying cycles. The dynamic load range at the front end of the rope during jumbo conveying cycles is therefore equal to the maximum rope load that occurred at the front end during such cycles.

Inspection of the figures further shows that the minimum back end rope load was equal to the (static) weight of the maximum length of suspended rope for both jumbo cycles. This was also the case for a rock hoisting cycle. The dynamic load range at the back end of the rope during

jumbo conveying cycles is therefore equal to the maximum rope load that occurred at the back end during such cycles, minus the weight of the maximum length of suspended rope.

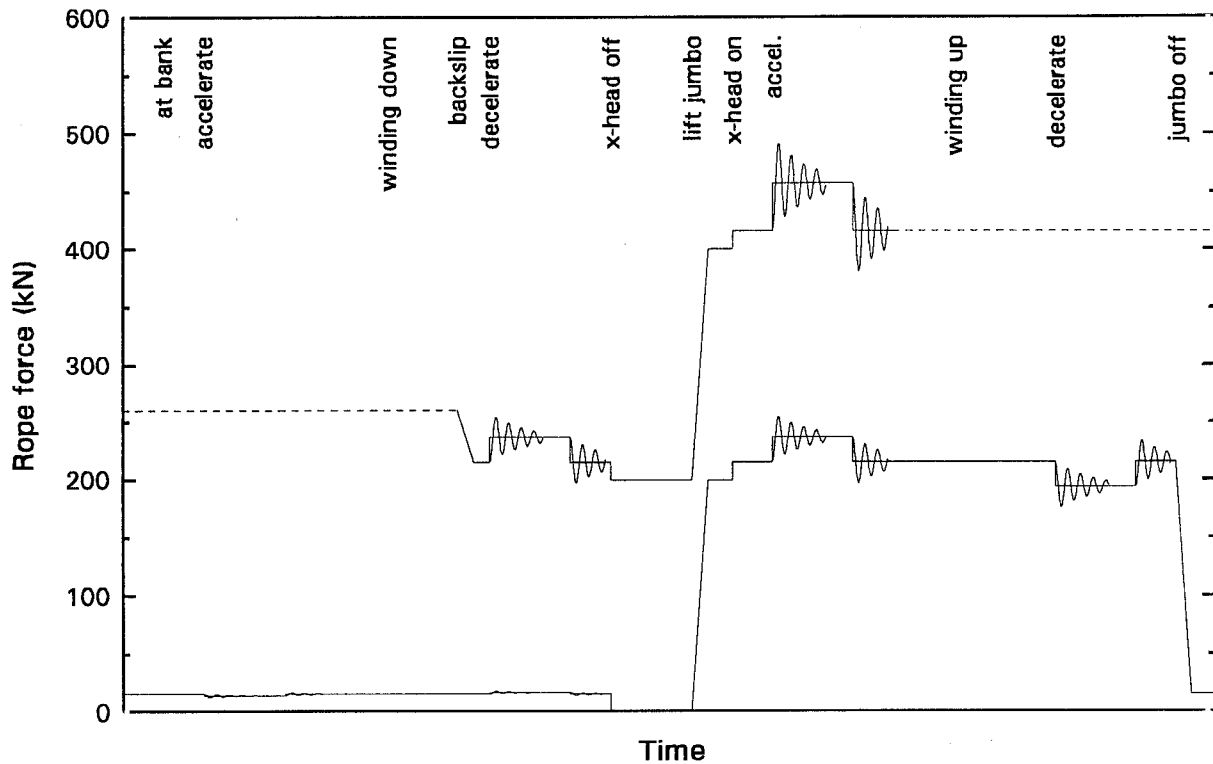

Figure 3: Schematic of the rope forces at the front end and back end of a rope during conveying of the jumbo drilling rig from shaft bottom.

Therefore, the load range for any part of the rope during a jumbo conveying cycle is equal to the maximum rope load that occurred at that part of the rope minus the weight of the rope below that point. The largest load range during jumbo conveying cycles occurs at the back end of the rope. The same conclusion was reached for a rock hoisting cycle.

4.2.3 Other conveying cycles

Any other piece of equipment or array of items conveyed by slinging from the front end of the rope will behave in a manner similar to that shown for the jumbo conveying cycles. The load range for such cycles is therefore determined in the same way.

Conveying men and material and "pumping" water with the kibble from shaft bottom differ from the other events in that the empty kibble may not necessarily be removed from the front end of the rope during such winding cycles. If the load range for such a winding cycles is determined as before (the maximum rope load that occurred at a section of the rope minus the weight of the rope below that point), it will be over-estimated.

This of no real consequence because men, material and water loads are always less than rock loads. The frequency of occurrence of these winding cycles is also far less than rock hoisting cycles.

5. THEORETICAL ANALYSIS OF LOAD RANGE

The variables and constants used in the calculations that follow in this section are:

R_{range}	=	load range (expressed as a force)
R_{ratio}	=	load range ratio (load range as a fraction of the rope breaking strength)
F_{break}	=	the breaking strength of the rope
L	=	suspended length of rope (shaft depth)
f_{SF}	=	safety factor (see <i>Definitions</i> , para 2, p 2)
f_{CF}	=	capacity factor (see <i>Definitions</i> , para 2, p 2)
m_{attach}	=	the mass attached at the front end of the rope
m_{rope}	=	the suspended rope mass (at shaft depth)
m_{total}	=	the total suspended mass (rope mass plus attached mass at shaft depth)
g	=	gravitational acceleration (= 9,8 m/s ²)
a	=	constant winder acceleration (actually linear rope acceleration)
α	=	dynamic amplification factor (see <i>Appendix B</i> , p 28)
A	=	steel cross-sectional area of a rope (see <i>Appendix C</i> , p 40)
ρ	=	bulk density of a rope (= 9 100 kg/m ³ , see <i>Appendix C</i> , p 40)
η	=	rope efficiency (= 0,85 see <i>Appendix C</i> , p 40)
σ	=	tensile grade of the rope

5.1 THE CALCULATION OF LOAD RANGE

At some sinking installations, the jumbo drilling rig is heavier than a kibble filled with rock. The jumbo only does a down and up trip once every thirty to forty winding cycles, and then only on the one rope of a double drum winder. The attached loads during the "other" cycles are less than the rock winding loads. The calculation of load range will therefore only consider rock hoisting. (The load range for a load other than rock can, of course, be calculated by simply using that load in stead of the rock load.)

At the time that a kibble winder is accelerated to full speed and the maximum rope forces are generated, the back 30 m to 40 m of the total length of suspended rope will already be wound onto the drum. Taking this into account in the calculations that follow will complicate matters unduly, and will be of no significance for deep winding depths. Events at the back end of the rope will therefore be calculated on the full suspended length of rope.

In section 4 it was shown that the load range for any part of the rope during a winding cycle is equal to the maximum rope load that occurred at that part of the rope minus the weight of the rope below that point. It was also shown that the largest load range occurs at the back end of the winder rope.

Using this definition for the load range and Eqn 1, p. 3, for the maximum rope force gives the following equation for load range:

$$R_{range} = m_{total} [g + a(1 + \alpha)] - m_{rope} g \quad (2)$$

The total suspended mass is the sum of the rope mass and the mass attached to the front end of the rope. Substituting this in Eqn 2 gives:

$$R_{range} = m_{attach} [g + a(1 + \alpha)] + m_{rope} a(1 + \alpha) \quad (3)$$

The mass attached at the front end of the rope, m_{attach} , for rock hoisting is the sum of the crosshead mass, the kibble mass, and the rock load.

Equation 3 shows that the load range is largely determined by the mass attached at the front end of the rope, and to a lesser extent by the rope mass. For a given attached mass, the load range will increase with shaft depth, because the rope mass increases. It also means that the load range can only remain constant with increasing shaft depth if the attached mass is reduced accordingly.

When the *formula* for permanent drum winder installations was derived¹, an equation for the safety factor, $25\,000/(4\,000+L)$, was established such that the load range ratio of the winder rope would be the same for any depth of wind. The depth of a permanent winder is fixed, while the depth of a kibble winder increases all the time.

5.2 LOAD RANGE RATIO

5.2.1 Load range in terms of the safety factor

The equation for load range (Eqn 2) can be rewritten in terms of rope parameters and the safety factor by making the following substitutions. By definition:

$$R_{range} = F_{break} R_{ratio} \quad (4)$$

The safety factor is equal to the breaking strength of the rope divided by the total (suspended) weight. Therefore:

$$m_{total} = \frac{F_{break}}{f_{SF} g} \quad (5)$$

That gives:

$$R_{ratio} F_{break} = \frac{F_{break}}{f_{SF} g} [g + a(1 + \alpha)] - m_{rope} g \quad (6)$$

The rope breaking strength and the rope mass are given by the following formulae derived in Appendix C, p. 40:

$$F_{break} = \eta \sigma A \quad (7)$$

$$m_{rope} = \rho A L \quad (8)$$

Replacing the rope breaking strength and the rope mass in Eqn 6 gives:

$$R_{ratio} \eta \sigma A = \frac{\eta \sigma A}{f_{SF} g} [g + a(1 + \alpha)] - \rho A L g \quad (9)$$

Eliminating A , and dividing both sides by $\eta\sigma$ gives:

$$R_{ratio} = \frac{1}{f_{SF}} \left[1 + \frac{a}{g}(1 + \alpha) \right] - \frac{\rho g}{\eta \sigma} L \quad (10)$$

Equation 10 gives the load range ratio in terms of the length of suspended rope (shaft depth), the rope safety factor, and the rope parameters (tensile grade, bulk density, and rope efficiency).

Example: Say that the normal winding (constant) acceleration of a kibble winder is 1 m/s^2 and $\alpha = 0,8$. If this winder is equipped with $2\,000 \text{ MPa}$ ropes that have a safety factor of, say, $4,0$ at a depth of $2\,000 \text{ m}$, the ropes will have a load range of 19% of the breaking strength of the rope at that depth.

5.2.2 A formula for kibble winder safety factors

A formula similar to the one derived for permanent drum winders can be derived for kibble winders by turning Eqn 10 around to make safety factor the object of the equation:

$$f_{SF} = \frac{1 + \frac{a}{g}(1 + \alpha)}{R_{ratio} + \frac{\rho g}{\eta \sigma} L} \quad (11)$$

With the above formula, and for a required load range ratio, a safety factor at a given depth can be calculated. The formula therefore gives the shape of the safety factor as a function of depth that will limit the load range ratio of the rope to a required value.

Equation 11 will have a more familiar appearance if it is rewritten in terms of two constants A and B as follows:

$$f_{SF} = \frac{A}{B + L} \quad (12)$$

Table 1 lists values for A and B for different values of winder acceleration and rope tensile grade. The load range ratio was set at 15% , and a value of $0,8$ was assumed for α , the dynamic amplification factor. The table also lists values of the safety factor required for depths of 0 m , $2\,000 \text{ m}$ and $4\,000 \text{ m}$.

The values for the safety factors, at a given depth, in Table 1 may appear contradictory. With and acceleration of 1 m/s^2 , the $1\,800 \text{ MPa}$ rope safety factor at $4\,000 \text{ m}$ can be as low as $2,90$ to give a load range ratio of 15% . For the $2\,200 \text{ MPa}$ rope, the load range will be higher than 15% as soon as the safety factor for the same $4\,000 \text{ m}$ depth is less than $3,47$. This is so, because for the same safety factor the higher tensile grade rope will have a larger attached load at the rope front end.

Table 1: Values for the constants of Eqn 12, and the safety factors required at different depths to limit the load range ratio to 15% for different rope tensile grades and winder dynamics.

15% load range ratio $\alpha = 0,8$	Winder acceleration			Values for the constants of the formula, and required safety factors at different depths
	0,6 m/s ²	0,8 m/s ²	1,0 m/s ²	
Tensile grade of the rope				
1 800 MPa	19 050	19 680	20 310	= A
	2 570	2 570	2 570	= B
	7,40	7,65	7,89	= f_{SF} at 0 m
	4,16	4,30	4,44	= f_{SF} at 2 000 m
	2,90	2,99	3,09	= f_{SF} at 4 000 m
2 000 MPa	21 160	21 860	22 560	= A
	2 860	2 860	2 860	= B
	7,40	7,65	7,89	= f_{SF} at 0 m
	4,36	4,5	4,64	= f_{SF} at 2 000 m
	3,09	3,19	3,29	= f_{SF} at 4 000 m
2 200 MPa	23 280	24 050	24 820	= A
	3 150	3 150	3 150	= B
	7,40	7,65	7,89	= f_{SF} at 0 m
	4,52	4,67	4,82	= f_{SF} at 2 000 m
	3,26	3,37	3,47	= f_{SF} at 4 000 m

Example: For a rope tensile grade of 2 000 MPa, a winder acceleration as 0,8 m/s², $\alpha = 0,8$ and a load range ratio of 15%, the *formula* becomes:

$$f_{SF} = \frac{21\ 860}{2\ 860 + L} \quad (13)$$

As long as the safety factor at a given shaft depth and for a given set of winder and rope parameters is equal or greater than the value given by the *formula*, the load range ratio will be equal to or less than 15%.

The required shape of the safety factor for kibble winder ropes is compared to the *formula* for permanent drum winder installations in Fig. 4. Three different tensile grades are shown for the shape of the kibble winder safety factor. Although the accelerations of kibble winders are more in the order of 0,8 m/s², a rate of 1 m/s² was chosen for the comparison in Fig. 4, because that was the value used when the *formula* for permanent drum winder installations was derived.

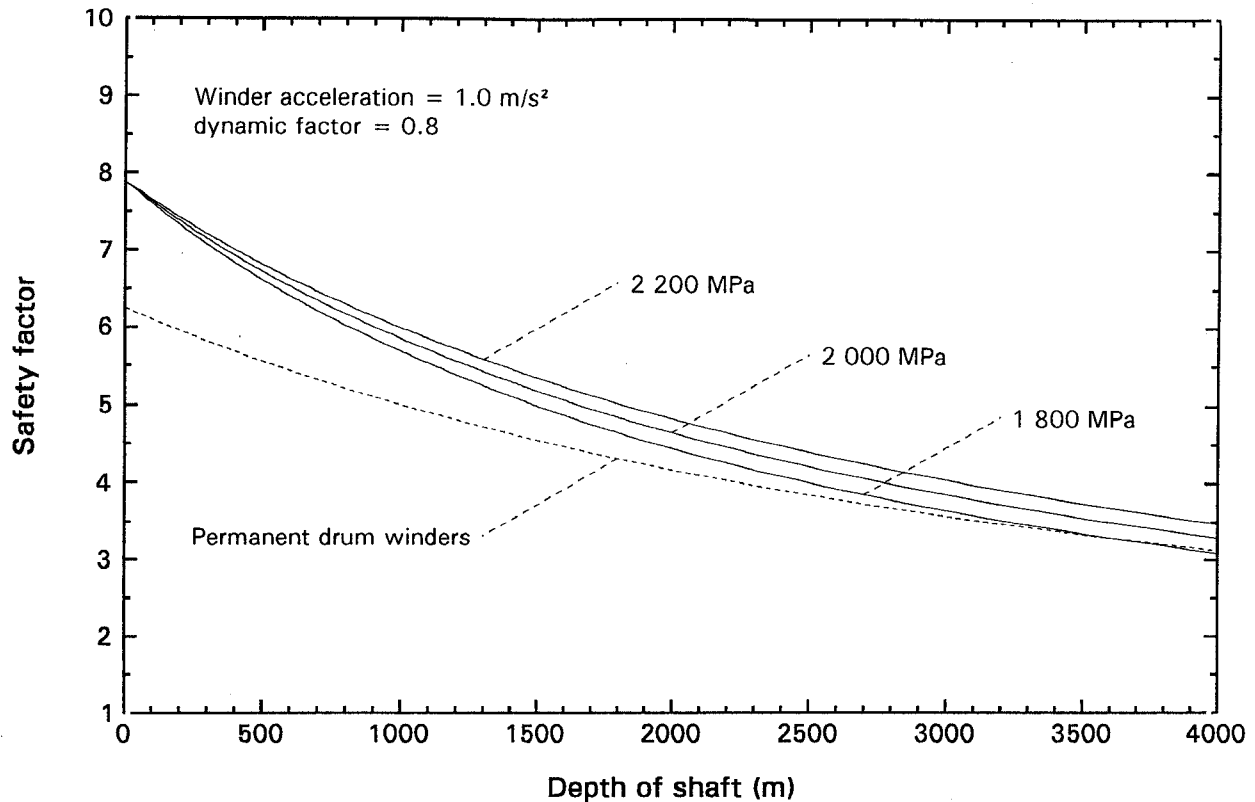

Figure 4: Comparison of the safety factor formula for permanent drum winders and the required shape of the safety factor for kibble winders.

The shapes of the kibble winder safety factors in Fig. 4 are the same as listed under the "1 m/s²" column in Table 1. The figure shows that kibble winder ropes generally require larger safety factors than permanent drum winder ropes for the same load range ratio limit.

For a load range ratio of 15%, the *required shape* of the rope safety factor for kibble winders was derived in this section. Although such a solution will restrict the load range ratio to the desired value, it is not a practical solution for kibble winders, simply because the depth of wind increases all the time.

5.2.3 Load range in terms of the capacity factor

If the rope and loading parameters of a kibble winder remain the same from the start of the sinking operations until final depth (this is generally the case), the rope capacity factor will remain constant (by definition). A kibble winder is therefore a constant capacity factor winder.

In stead of deriving a *formula* for safety factor that will keep the load range in check, a capacity factor may also exist that will have the same effect.

By definition, the safety factor is:

$$f_{SF} = \frac{F_{break}}{g(m_{attach} + m_{rope})} \quad (14)$$

By definition, the capacity factor is:

$$f_{CF} = \frac{F_{break}}{m_{attach} g} \quad (15)$$

Replacing the attached mass in Eqn 14 by the capacity factor (Eqn 15), and rope breaking strength and rope mass with Eqns 7 and 8, yields an equation relating safety factor and capacity factor:

$$f_{SF} = \frac{1}{\frac{1}{f_{CF}} + \frac{\rho g}{\eta \sigma} L} \quad (16)$$

Equation 16 is of the same form as Eqn 11, minus the dynamics. This is so because, for a kibble winder, the capacity factor is the reciprocal of the static load range.

For interest: Replacing, for example, a constant capacity factor equal to 9 and a tensile grade of 2 000 MPa into the equation above, also yields a *safety factor formula*. This formula describes a constant capacity factor and therefore a constant static load range ratio for a kibble winder rope:

$$f_{SF} \approx \frac{19\,000}{2\,100 + L} \quad (17)$$

Equation 16 can also be written as:

$$\frac{1}{f_{SF}} = \frac{1}{f_{CF}} + \frac{\rho g}{\eta \sigma} L \quad (18)$$

The load range ratio can be expressed in terms of the capacity factor by either replacing the safety factor by the formula above or by replacing the attached mass in Eqn 3, p. 10, with that of Eqn 15. This gives:

$$R_{ratio} F_{break} = \frac{F_{break}}{f_{CF} g} [g + a(1 + \alpha)] + m_{rope} a(1 + \alpha) \quad (19)$$

Replacing the rope breaking strength and rope mass in Eqn 19 with Eqns 7 and 8, and simplifying gives the load range ratio in terms of the capacity factor, winder dynamics and rope parameters:

$$R_{ratio} = \frac{1}{f_{CF}} \left[1 + \frac{a}{g} (1 + \alpha) \right] + \frac{\rho a (1 + \alpha)}{\eta \sigma} L \quad (20)$$

Figure 20 shows the load range ratios for two different capacity factors, three different rope tensile grades and three different winder accelerations (the latter all for $\alpha = 0,8$).

5. WINDER DECELERATION AFTER BRAKE CONTROL FAILURE

5.1 WINDER BRAKES AND BRAKE CONTROL

The layout and design of drum winder brakes and their control systems, together with a brief analysis of effects of brake control failure, are given in Appendix C. It is shown that the brakes of a drum winder are normally designed to have a braking torque capacity equal to some multiple of the maximum unclutched out-of-balance torque of the winder, for example:

A double drum winder with one brake per drum will normally have a brake design torque capacity of two times maximum unclutched out-of-balance plus 10% for each of the two brakes; i.e. 2,2 times out-of-balance per brake. During emergency braking, such a winder will be able to stop normally on one of the brakes only. The actual friction coefficient of the brake lining material is usually greater than the design value, which further increases the capacity of the brakes. It is shown that each brake of a double drum winder could have a capacity of 2,5 times the maximum unclutched out-of-balance torque.

In the rest of this report, the maximum unclutched out-of-balance torque of a winder will be referred to as the "Brake OoB torque", and the rope force value that produces this torque will be referred to as "Brake OoB".

In Appendix C it is further shown that the brake efforts that can be applied after brake control failure are as follows in terms of "Brake OoB":

- 2,5 times for a double drum with two brakes and two (independent) control systems.
- 2,5 times for a BMR or double drum with four brakes and two control systems.
- 1,67 times for a double drum with three brakes and three control systems.
- 1,25 times for a BMR or double drum with four brakes and four control systems.

For the above, it was assumed that the total design braking capacity of each of the above winder configurations was 4,4 times "Brake OoB". The actual (maximum) total brake capacity would then be 5 times "Brake OoB".

5.2 WINDER PARAMETERS

Eighteen different double drum winder configurations were investigated to determine the brake effort required to produce the critical winder decelerations of the preceding section. The winders were designated "No. 1" to "No. 18" and are listed in Tables 1 and 2 (pages 24 to 27). These winders cover a wide range of possible winder configurations. The winder parameters, listed in the top halves of the tables, were selected and calculated as follows:

The winders were designed for permanent hoisting duties. It was assumed that all the winders could be used as kibble winders. All the winder motors were directly coupled to the drum shafts.

A rope diameter and shaft depth was selected for each winder. A rope tensile grade of 2 000 MPa was used for all the ropes. Rope mass per unit length and the rope breaking strength were selected according to average values for non-spin ropes given in the Haggie Rand Rope Catalogue.

A realistic safety factor was selected for each winder. The total (maximum) attached mass could

Equation 20 can also be written with the capacity factor as the object of the equation:

$$f_{CF} = \frac{1 + \frac{a}{g}(1 + \alpha)}{R_{ratio} - \frac{\rho a(1 + \alpha)}{\eta \sigma} L} \quad (21)$$

Equation 21 gives a *capacity factor formula* for kibble winder ropes. For a given load range ratio, rope tensile grade and winder dynamics, this equation gives the minimum capacity factor that is required to maintain the given load range ratio.

The capacity factors required for a kibble winder installation to maintain a load range ratio of 15% are shown Fig. 21 for three different rope tensile grades and three winder accelerations (with the dynamic factor = 0,8).

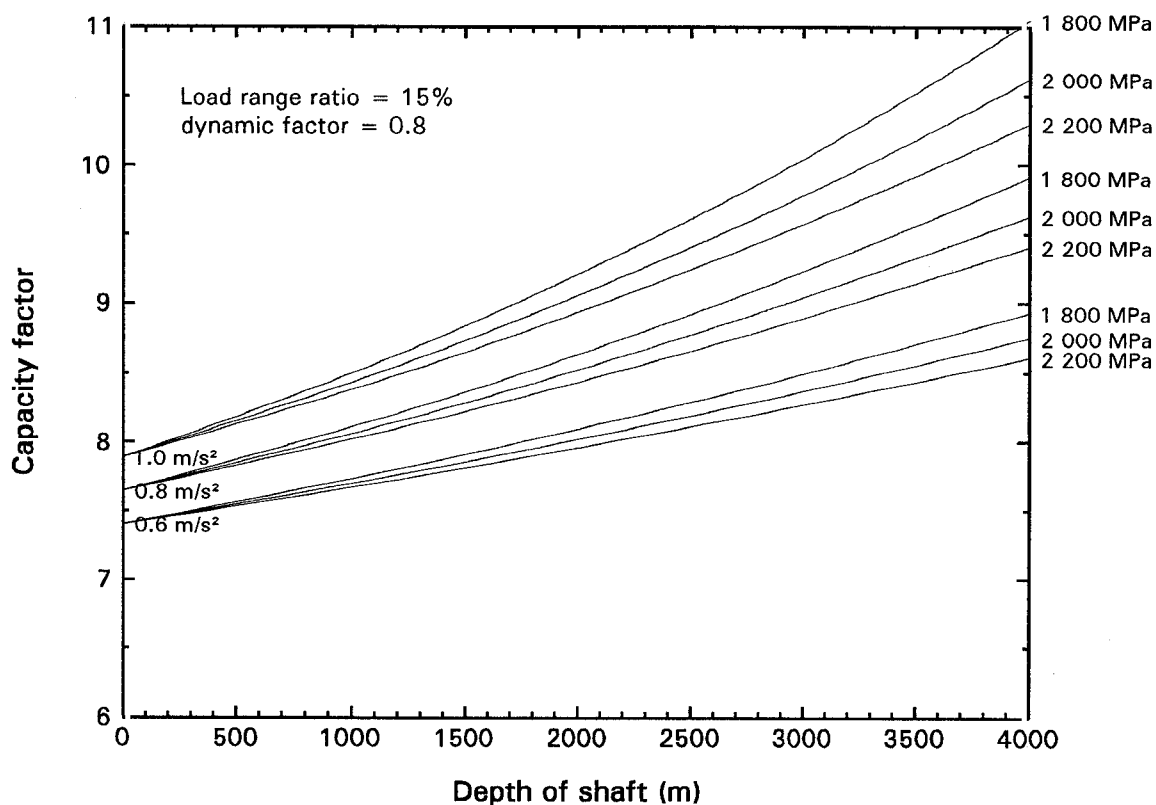

Figure 6: Capacity factors that are required to limit the load range ratio to 15%, as functions of shaft depth, and for three different rope tensile grades, and three different winder accelerations.

The capacity factor of a kibble winder will normally be the same throughout the sinking of a shaft. The capacity factor of a kibble winder rope will have to be selected such that the load range ratio limit is maintained at the final depth.

5.2.4 Load range in terms of the capacity factor and safety factor

Equation 10, p. 11, for the load range ratio of a kibble winder rope can be written in terms of both the capacity factor and the safety factor by substituting Eqn 18, p. 14, into Eqn 10. This gives:

$$R_{ratio} = \frac{1}{f_{SF}} \left[\frac{a}{g} (1 + \alpha) \right] + \frac{1}{f_{CF}} \quad (22)$$

If the safety factor and the capacity factor is known for a certain depth, the rope parameters and the shaft depth have already being taken into account, and they are therefore absent in Eqn 22. A further point of interest is that the static and dynamic parts of the load range ratio are separated in this equation. The reciprocal of the capacity factor is the static load range ratio of a kibble winder. The first part of the equation therefore represents the dynamic component of the load range ratio.

6. PROPOSED REGULATIONS FOR KIBBLE WINDER ROPES

Approaches to new regulations for kibble winder ropes are postulated in this section. The decision on what will be implemented will be determined by discussions with the Department of Mineral and Energy affairs and the mining and shaft sinking industry.

6.1 THE PURPOSE OF WINDER ROPE REGULATIONS

Rope factors (regulations) for running ropes should have the following objectives:

- The rope load variation during normal (regular) winding duties should remain within certain limits to ensure that the rate of deterioration of the rope is controlled. Deterioration of the rope includes surface plastic deformation, surface wear, and broken wires. Rope deterioration leads to a reduction in rope strength, and ultimately to rope discard.
- A permissible level of rope deterioration should be prescribed: This is the level after which the rate of rope deterioration increases rapidly. Currently this level is a 10% reduction in rope strength.
- A maximum rope force should be prescribed. The largest rope force occurs during emergency braking with a full load descending near the bottom of the shaft.

The current regulations for drum winder ropes have been established through an evolutionary process since the start of this century. Although it may not always have been the explicit intention to fulfil the requirements of the objectives listed above, the current drum winder regulations do exactly that:

A rope is to be discarded when its strength has reduced by 10%. The capacity factor limits the load range to a degree and therefore controls the rope deterioration. The safety factor limits the maximum rope loads.

The first part of the proposed drum winder regulations given in Appendix A also prescribes a capacity factor (= 8) and a safety factor (= 4,5). In the second part of the proposed regulations, the capacity factor has been replaced with a *safety factor formula* and the winder has to comply with a code of practice. The purpose of the formula is to limit the cyclic load range of the rope to 15% of the rope breaking strength. The maximum permissible rope force for a winder that makes use of this formula is limited to 40% of the rope breaking strength through a stipulation in the winder code of practice.

The relation between the maximum (dynamic) rope force and the (static) safety factor is given in Appendix D, p. 42. The safety factor of 4,5 is shown to be adequate for both permanent and kibble winder installations.

6.2 THE FORM OF KIBBLE WINDER REGULATIONS

Ideally, the regulations that govern the strength of kibble winder ropes should have a form similar to the regulations for permanent drum winders: One part that will allow sinking operations as in the past, and a second part that will allow the sinking of deep shafts. Compliance with a code of practice will then be a requirement of the second part of the regulations.

6.3 A LOGICAL APPROACH TOWARDS NEW REGULATIONS

Currently, kibble winders make use of the same rope strength regulations as permanent drum winders.

The implication of the proposed regulations for drum winders (given in Appendix A) is therefore that kibble winder ropes should be allowed to operate with the greater of a capacity factor of 8,0 and a safety factor of 4,5. (The first part of the proposed drum winder factors.)

The implication of the second part of the proposed regulations is that, if reduced factors are required (as would be the case for deeper shafts), a kibble winder will have to comply with the requirements of a code of practice, together with some specified rope factor or rope factor formula.

The capacity factor of a kibble winder rope remains constant as the depth of the shaft increases (except, of course, if the rope parameters or the kibbles are changed at some point). The logical approach would therefore be that a kibble winder will be allowed to operate with a given capacity factor (the first part of the regulations) until such a depth where the safety factor limit (= 4,5) is reached. From this depth onwards, for the same capacity factor, the safety factor will be less than that required by the first part of the regulations, and the winder then will have to comply with a code of practice (the second part of the regulations).

In other words, the capacity factor of a sinking winder rope stays the same throughout the sinking process (i.e. the same rope size and attached mass). The kibble winder only has to comply with a code of practice from the point that the safety factor of the rope will be less than 4,5. The *safety factor formula* would be the capacity factor in this case.

The attractiveness of such a solution is that shafts can be sunk as in the past. In the case of deep shafts, compliance with a code of practice will then only be required from a certain depth. This will give a deep sinking winder installation ample time to implement the requirements of a code of practice.

Furthermore: A constant capacity factor will effect the same static rope load range throughout the sinking process.

What remains now is to select an appropriate capacity factor for kibble winders, or to show that the capacity factor of 8 is adequate for kibble winders.

6.4 ANALYSIS OF THE CAPACITY FACTOR APPROACH

For any constant rope capacity factor, the safety factor of the rope will decrease with increasing shaft depth. For a specified minimum rope safety factor, the depth (or length of suspended rope) at which the safety factor limit is reached will be termed the transition depth. The transition depth will be the depth from which onwards a kibble winder installation will have to comply with the requirements of a code of practice.

6.4.1 Shaft depth less than the transition depth

The transition depth for a given capacity factor, safety factor and a set of rope parameters can be calculated with Eqn 18, p. 14. Transition depths for three different rope tensile grades and a safety factor limit of 4,5 are given in Table 2.

At the transition depth, both the capacity factor and the safety factor have prescribed values. The load range ratio can then be calculated with Eqn 22, which shows that for such a case the load range ratio depends only on the winder dynamic behaviour. For example:

For a capacity factor of 8, the transition depth is 1 670 m for a 1 800 MPa rope, and 2 040 m for a 2 200 MPa rope. For a winder acceleration of 1 m/s² (and $\alpha = 0,8$), the load range ratio at the transition depth will be the same, i.e. 16,6% at 1 670 m for the 1 800 MPa rope, and 16,6% at 2 040 m for the 2 200 MPa rope.

The load range ratios for three different winder accelerations at the transition depth are also given in Table 2. The load range ratios for depths less than the transition depth will, of course, be less than the listed values.

Table 2: Transition depths and load range ratios for a number of capacity factors, three different rope tensile grades and three different winder accelerations.

Safety factor = 4,5	Transition depth: (safety factor limit) for different rope tensile grades			Load range ratio at the transition depth for three different winder accelerations and $\alpha = 0,8$		
	1 800 MPa	2 000 MPa	2 200 MPa	0,6 m/s ²	0,8 m/s ²	1,0 m/s ²
8	1 670 m	1 850 m	2 040 m	14,9%	15,8%	16,6%
9	1 910 m	2 120 m	2 330 m	13,6%	14,4%	15,2%
10	2 100 m	2 330 m	2 560 m	12,4%	13,3%	14,1%
11	2 250 m	2 500 m	2 750 m	11,5%	12,4%	13,2%
12	2 380 m	2 650 m	2 910 m	10,8%	11,6%	12,4%

Table 2 shows that reasonably deep shafts can be sunk with a capacity factor of 11 to 12 before the safety factor limit of 4,5 is reached. A recent example of such a shaft is Vaal Reefs 11 Shaft⁴, which had a capacity factor of 12,5 and would still have had a safety factor of 4,7 at a depth of 2 500 m.

The load range ratios at the transition depths are all less than 15% for capacity factors of 9 and higher. With a capacity factor of 8 and a winder acceleration of 0,8 m/s² (a likely value), a load range of 15% is reached at around half the transition depth. A rope with a capacity factor of 8 will already have a static load range of 12,5%.

Judging simply from the values given in Table 2, a capacity factor of 9 should be prescribed for kibble winders. However, before the possibility of a capacity factor of 8 is discarded, the following should be taken into account:

- All shafts, except shallow ones, use starter ropes on the kibble winders. Starter ropes are used because of the possibility of accidental damage to the rope during the early part of the sink, and because of difficulty tensioning a large number of dead coils on the kibble winder drums with only a shallow shaft to let the rope down in. Generally, starter ropes are used ropes and it is not uncommon for a shaft sinking installation to use these ropes for depths to around 1 500 m.

- If a shaft has one double drum kibble winder, generally not more than 20 000 winding cycles will be required for each rope for every 1 000 m of shaft sunk. Approximately one half of these winding cycles will be used for rock hoisting.
- Dead coils on the kibble winder drum progressively become live as the shaft depth increases. The load range increases with increasing shaft depth. The rope sections subjected to the higher load ranges will therefore be exposed to fewer winding cycles.
- The allowable 15 % load range ratio is not an absolute limit. When the permanent drum winder regulations were proposed¹ this value was selected as being the upper limit of current winder experience. A relatively small number of winding cycles at a load range ratio of, say, 17 % will do no more damage to a winder rope than when being continuously subjected to a load range ratio of 15 %.
- It could be the case that a sinking installation may want to use starter ropes of 1 800 MPa and a capacity factor of 8, and then change to 2 000 MPa ropes for the rest of the sink, and to extend the transition depth.

Taking the above into account, it is concluded that a capacity factor of 8 will give sufficient protection against rope deterioration on kibble winders.

6.4.2 Beyond the transition depth

Beyond the transition depth, the safety factor will be less than the 4,5 limit, and such kibble winders will have to comply with the requirements of a code of practice. A limit of 15 % for the load range ratio will have to be one of the requirements of such a code of practice. The proposed code of practice for permanent winder installations contains such a requirement.

Figure 6, p. 16, shows that it should be relatively easy to maintain a load range ratio of 15 % to great depths if the capacity factor is 10 and higher. The rope behaviour with capacity factors of 8 and 9 will be considered in this section.

Figure 5, p. 15, shows the load range ratios for capacity factors of 8 and 9 for different winder dynamic behaviours and three different tensile grades. The figure shows that the dynamics of a kibble winder will have to be well controlled to maintain a 15 % load range ratio if the capacity factor equals 8 and the depth of the shaft is greater than 3 000 m. With a capacity factor of 9 the winder dynamic behaviour will not be that critical.

The *required shape* of the rope safety factor was defined as the safety factor that is required at a given shaft depth in order to maintain a 15 % load range ratio. This shape depends on the rope tensile grade and the dynamic behaviour of the winder (see section 5.2.2, p. 11).

Three cases of the approximation of the *required shape* of the safety factor by constant capacity factors of 8 and 9 are shown in Figs 7, 8, and 9. The other six combinations of winder acceleration and rope tensile grades are shown in Appendix E. The required safety factor shape for the various cases are quite well approximated by capacity factors.

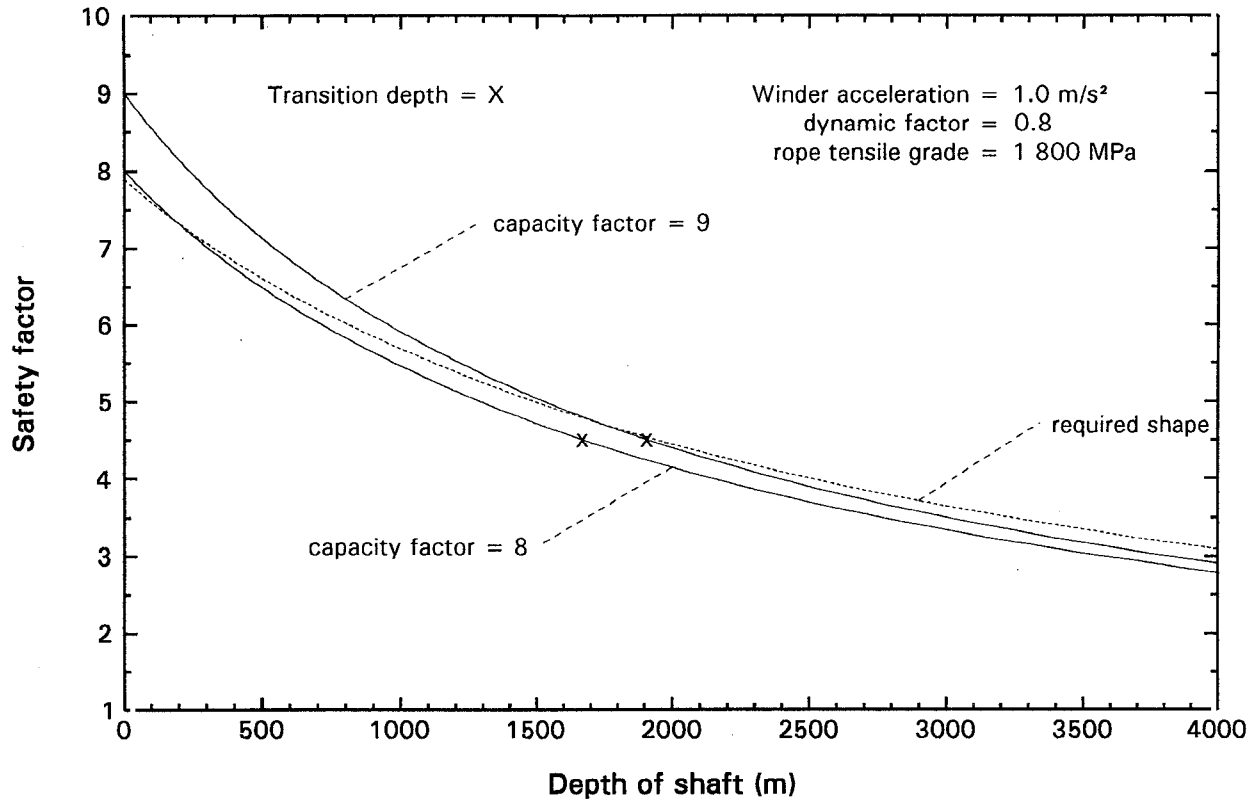

Figure 7: Comparison of the capacity factor approach and the required shape of the safety factor for kibble winders.

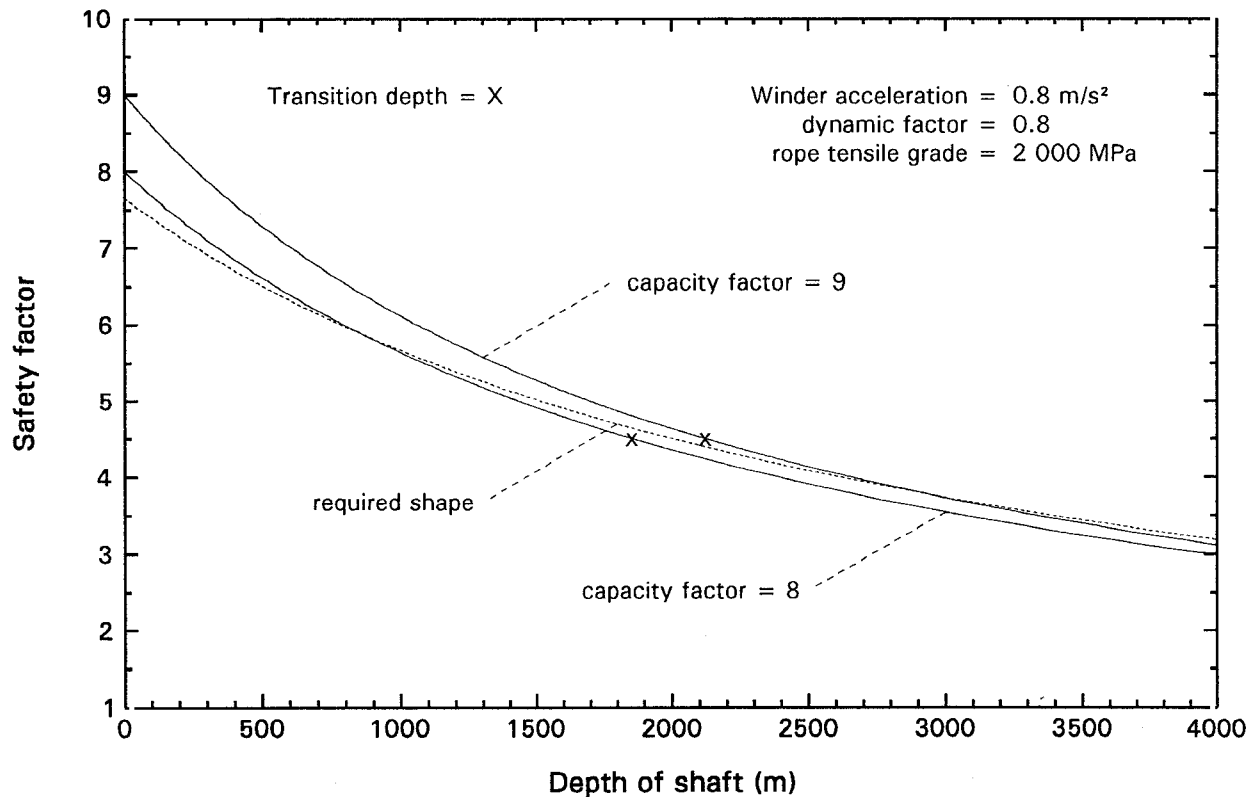

Figure 8: Comparison of the capacity factor approach and the required shape of the safety factor for kibble winders.

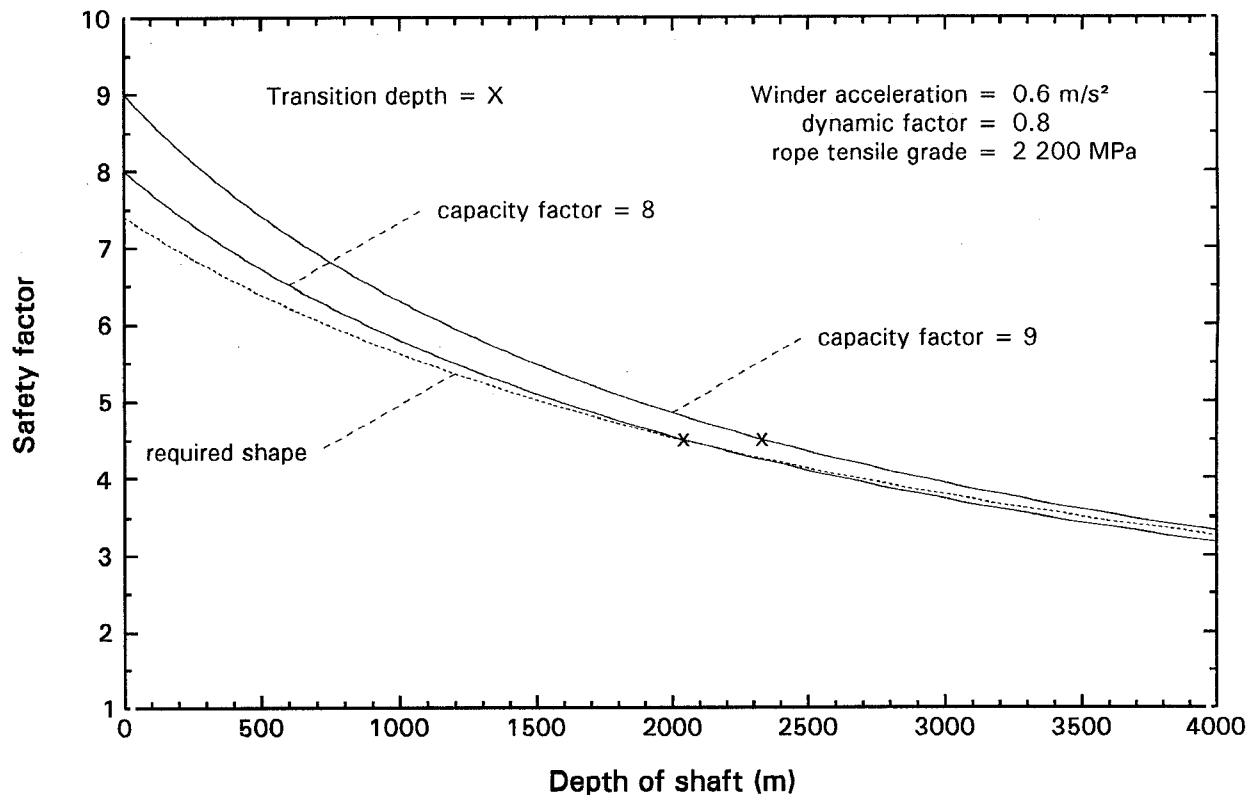

Figure 9: Comparison of the capacity factor approach and the required shape of the safety factor for kibble winders.

All future deep shafts will not be sunk to a depths of 4 000 m. If, further, the sinking winder code of practice prescribes a limit of 15% for the load range ratio, then the onus is on the operators of a shaft sinking installation to select a capacity factor such that the load range ratio remains within limits.

A capacity factor of 8 should therefore be specified as the *safety factor formula* for kibble winders that will comply with the requirements of a code of practice.

6.5 CHANGES REQUIRED TO THE REGULATIONS

If the regulations proposed for kibble winders in the section above meets the approval of all concerned parties, kibble winders will in affect still make use of the same regulations as permanent drum winder installations (proposed regulation 16.29.1).

The *safety factor formula* of proposed regulation 16.29.2 is not applicable to kibble winders. To implement the proposed capacity factor of 8 together with a sinking winder code of practice, it is proposed to add a third part to proposed regulation 16.29. The wording of 16.29.3 could be:

Where a winding system is used for the sinking of a vertical shaft and if this shaft sinking installation complies with an approved safety standard pertaining to the performance, operation, maintenance and testing of winders used for shaft sinking in as far as it affects rope safety and deterioration, and notwithstanding the provisions of regulations 16.29.1 a winding rope of a winder shall have an initial breaking strength at least equal to eight times the effective combined weight of the conveyance and its attachments and the maximum permitted load of persons, material, explosives or mineral.

7. LOAD RANGE FROM ROPE FORCE MEASUREMENTS

7.1 ROPE FORCE MEASUREMENTS

The proposed code of practice for permanent drum winder installations² requires the continuous monitoring of the rope forces of a winder. The measured rope forces are to be used for the determination of the cyclic load range ratio, and to check the maximum rope forces during emergency braking.

It is therefore conceivable that the code of practice for sinking winders will also include such a requirement.

The rope forces during shaft sinking operations had been measured at three different sinking installations.^{4,5,6} At each of these installations the kibble winder rope forces were recorded for at least a 24 hour period together with the winder speed and the positions of the front ends of the ropes in the shaft.

The extraction of load range ratios from measured kibble winder rope forces is discussed in this section. It is done to show the type of results that would be obtained if such systems were employed on kibble winder installations. The recorded rope forces^{4,5,6} will be assumed as accurate and correct for the purposes of this exercise.

The code of practice for permanent drum winder installations allows for the measurement of the rope forces either at the front end of the rope or in the headgear. It also presents various methods of extracting the load range from the rope force measurements. A kibble winder only allows for the measurement of the rope forces in the headgear. Front end rope force measurement is impracticable on such installations.

7.2 PRACTICAL LOAD RANGE DETERMINATION

The load range for a winding cycle has been defined as the maximum load range that occurs in any part of the rope during one complete winding cycle.

In section 4.2, p. 5, it was shown that the largest dynamic components of the rope force occur at the back end of a winder rope (i.e. at the headgear sheave where the rope forces were measured for the kibble winders). It was also shown that the load range for any part of the rope during a winding cycle is equal to the maximum rope load that occurred at that part of the rope minus the weight of the rope below that point.

The maximum load range during a winding cycle of a kibble winder rope is therefore calculated simply by subtracting the weight of the suspended rope length at any point during the winding cycle from the measured (back end) rope force, and determining the maximum of these results for the complete winding cycle. The maximum load range ratio is determined by dividing the maximum load range by the breaking strength of the rope. The position of the front end of the rope in the shaft needs to be recorded together with the rope force at the headgear sheave for the determination of the load range of kibble winder ropes.

The winder data and the results of the load range calculations from the rope forces measured at the three shaft sinking installations are given and shown in Appendix F.

8. CONCLUSIONS AND RECOMMENDATIONS

The analysis of the load range of kibble winders has confirmed that the *safety factor formula* of the proposed regulations for drum winder ropes is not applicable to kibble winder ropes.

The proposed rope regulations for drum winders that do **not** have to comply with the requirements of a code of practice are suitable and sufficient for kibble winder operations. These are a capacity factor of 8 and a safety factor of 4,5.

A kibble winder of which the rope safety factor is less than 4,5 will have to comply with the requirements of a code of practice. The *safety factor formula* for the ropes of such kibble winder installations should be a capacity factor of 8. One of the requirements of the code of practice for sinking winders will have to be a limit of 15% for the load range ratio of the winder rope.

The results from the calculation of load range ratios from actual kibble winder rope force measurements showed that the method presented in this report for such calculations from continuous rope force measurements is practicable.

The proposed rope strength regulations for permanent drum winder installations, as well as those proposed in this report for kibble winder ropes, are all based on a 15% limit to the load range ratio of a winding rope. This limit was established in a somewhat desultory way. Although it provides adequate scope for deep shaft sinking and winding, it is not known how crucial this selected limit is towards drum winder rope deterioration. This question should be addressed.

9. REFERENCES

1. Hecker, G F K: *Motivation for proposed changes to Chapter 16 of the Minerals Act; Rope safety regulations for drum winders.*
CSIR Contract Report MST(92)MC1674, June 1993.
2. SABS xxxx:199x: South African Standard: *Code of practice: Mine winding ropes and plant.* (Draft safety standard for the performance, operation, maintenance and testing of mine winding plant.)
3. Van Zyl, Mike: *Overview of the winding rope requirements for deep shaft sinking operations.*
CSIR Contract Report MC2736, No. 950373, April 1996.
4. Van Zyl, Mike: *Rope force measurements during shaft sinking operations at Vaal Reefs 11 Shaft.*
CSIR Contract Report No. 950373, December 1995.
5. Van Zyl, Mike: *Rope force measurements during shaft sinking operations at West Driefontein 10 Shaft.*
CSIR Contract Report No. 960374, January 1996.
6. Van Zyl, Mike: *Rope force measurements during shaft sinking operations at West Driefontein 9 Shaft.*
CSIR Contract Report No. 960375, February 1996.

APPENDIX A: PROPOSED REGULATIONS FOR DRUM WINDER ROPES

Rope factors and rope force limits that will allow permanent drum winder installations to operate to depths of 4 000 m have been proposed by Hecker¹. From these proposals, the Department of Mineral and Energy Affairs drew up the following regulations:

- 16.29.1 *Where the winding system is such that it allows for the periodic testing of the winding rope as required by regulation 16.34.1 and a balance rope is not used, a winding rope shall have an initial breaking strength equal to or exceeding the greater off -*
- (a) *eight times the effective combined weight of the conveyance and its attachments and the maximum permitted load of persons, material, explosives or mineral, or*
 - (b) *four and a half times the effective combined weight of the maximum suspended effective length of winding rope, the conveyance and its attachments and the maximum permitted load of persons, material, explosives or mineral.*
- 16.29.2 *Where a winding system operating in a vertical shaft is such that it allows for the periodic testing of the winding rope as required by regulation 16.34.1 and if a mine complies with an approved safety standard pertaining to winder performance, operation, maintenance and testing, in as far as it affects rope safety and deterioration, and notwithstanding the provisions of regulations 16.29.1 and 16.31 a winding rope of a winder shall have an initial breaking strength equal to $25000/(4000+L)$ times the effective combined weight of the length of winding rope, the conveyance and its attachments and the maximum permitted load of persons, material, explosives or mineral, where L is equal to the length of winding rope in metres.*

In these regulations, the same factors apply to men and rock, and the factors have been changed from "discard factors" to "installation factors". Installation factors are calculated on the initial breaking strength of a winding rope. The proposed Regulation 16.29.1 requires a capacity factor of 8,0 and a safety factor of 4,5.

The *safety factor formula* of proposed Regulation 16.29.2 will allow vertical drum winders to operate at depths greater than that allowed by Regulation 16.29.1. Winders that make use of the *formula* will have to comply with a code of practice (an "approved safety standard").

In his proposals, Hecker¹ included a dynamic factor of 2,5 to limit the maximum rope forces that can be generated during emergency braking. This limit, which is 40% of the breaking strength of a winding rope, is now part of the winder code of practice.²

APPENDIX B: WINDER ROPE DYNAMICS

In this section, an empirical formula is derived with which the maximum rope forces can be calculated when a winder rope, with a mass attached at its end, is given a constant acceleration at the drum end of the rope.

B1. ROPE FORCE CALCULATION MODEL

The winding rope, with an attached mass at its end, was approximated as a series of lumped masses and springs. The response of this system to a given input was then calculated at successive time intervals.

The stiffness of the spring elements representing the rope was derived from the elastic modulus of the rope. A *general rope elastic modulus* was derived by Van Zyl* from load-elongation measurements on a large number of rope samples. This elastic modulus was found to be a function of rope stress only, and is given by the following formula:

$$E = k_1 - \frac{k_2}{\sigma + k_3}$$

with: σ	=	rope stress based on the cross sectional steel area of a rope (GPa)
k_1	=	173 GPa
k_2	=	22,7 GPa ²
k_3	=	0,197 GPa

According to the Haggie Rand rope catalogue, the cross sectional steel area of the non-spin ropes used for shaft sinking is given by the following formula:

$$A = 0,5 d^2$$

with: A	=	cross-sectional steel area of the rope
d	=	diameter of the rope

A winder rope has internal damping characteristics. This can be verified by inspection of the data from any set of rope force measurements carried out on a mine winder. Although the exact nature of the internal rope damping has not yet been established, it is essential that some type of damping has to be included in rope force calculations to obtain realistic results.

A viscous type of damping, represented by the following stress-strain relationship, was included in the model used for the rope force calculations:

$$\sigma = E \left(\varepsilon + \beta \frac{\partial \varepsilon}{\partial t} \right)$$

* Van Zyl, Mike: *Load ranges experienced by drum winder ropes*. CSIR Contract Report MST(92)MC996, November 1992: Page 6.

with: σ	=	Rope stress based on the cross sectional steel area of the rope
E	=	elastic modulus of the rope
ε	=	rope strain
β	=	damping constant
t	=	time

The oscillations (force, displacement) in a rope of a stationary drum winder reduces by half in around five full oscillations. A $\beta = 0,025$ s in the stress-strain relationship above, produces such behaviour. Rope internal damping was provided to the model by incorporating a damper in parallel with each spring.

The accuracy of the numerical model used for the rope force calculations in this section was verified by comparing the results with an analytical method that was developed for the calculation of rope forces generated after the occurrence of slack rope**.

The rope properties (mass, elasticity and damping) are related to the rope cross-sectional area and rope length. This means that if the rope size (area) and attached mass of a winder system are both doubled (or both halved), the dynamic behaviour (period of oscillation and dynamic factors) will remain the same.

B2. GENERAL BEHAVIOUR

A winder with the following parameters was selected for the illustration and discussion of the general behaviour of the rope forces:

Length of suspended rope:	2 000 m
Total attached mass:	10 000 kg
Rope diameter:	47 mm
Cross sectional steel area of the rope:	1 110 mm ²
Rope mass:	10 kg/m

The selected rope parameters will be used in all the calculations in this appendix.

For the sake of interest: A 47 mm non-spin rope of 1 800 MPa tensile grade will typically have a strength of 1 700 kN.

The total rope mass for the selected winder is 20 000 kg, and the total suspended mass is 30 000 kg. A catenary (section between the drum and the headgear) was not included, and the inertia of the headgear sheave was neglected. The mass of the catenary and the equivalent linear mass of the headsheave is generally small compared to the total suspended mass. As their mass will only have an effect on the rope forces associated with accelerating the winder (and not on the part associated with gravity), the total effect will be small and can therefore be neglected. Including a catenary will add more elasticity to the winder rope. This will have an effect on the periods of the oscillations for short suspended rope lengths.

For the sake of having round numbers, the gravitational acceleration (g) was assumed to be equal to 10 m/s² for the calculations in this appendix. The elastic modulus and damping factors of the different sections of rope was calculated using the static rope load.

** Van Zyl, Mike: *Drum winder rope forces generated by the occurrence of slack rope - a mathematical model*. CSIR Contract Report MST(91)MC867, September 1991.

The rope forces generated when a constant acceleration of 1 m/s^2 (upwards) was applied at the drum end (back end) of the rope are shown in Fig. B1. The acceleration was applied instantaneously, and removed when a speed of 16 m/s was reached.

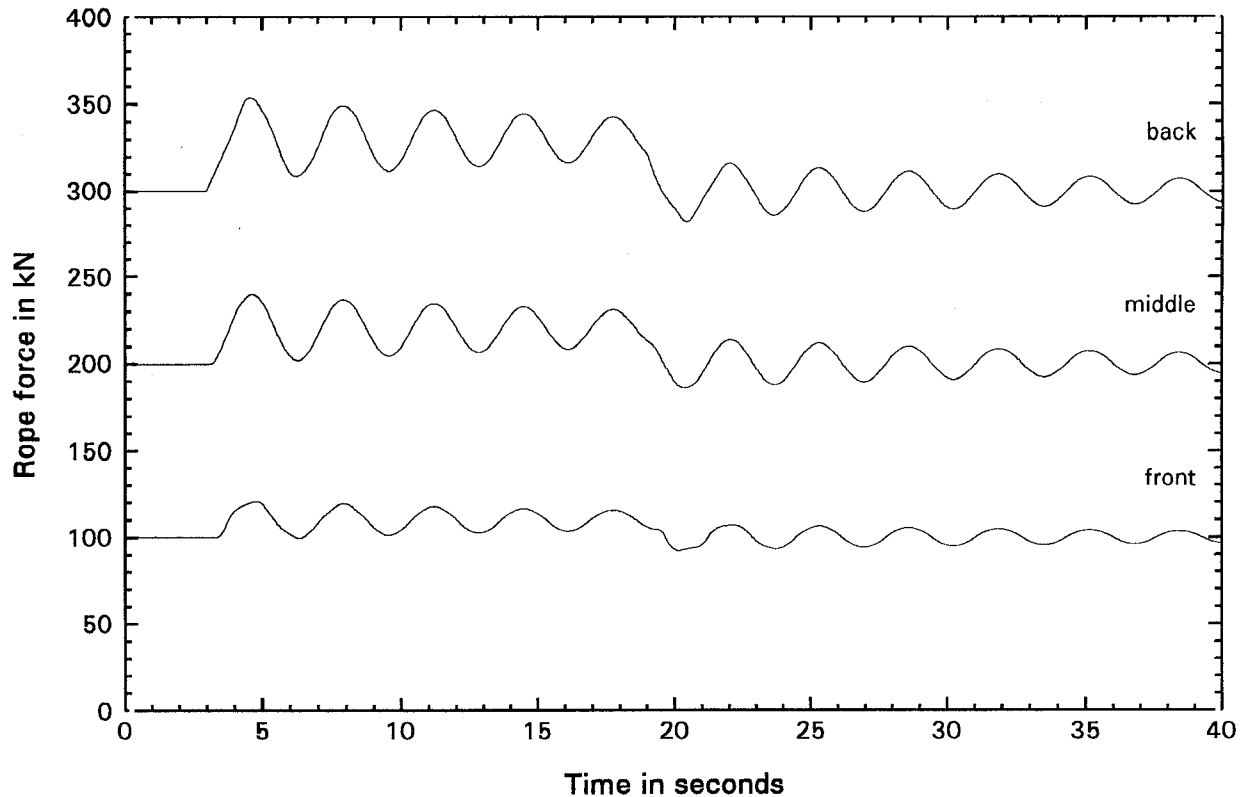

Figure B1: General behaviour of a winder rope when accelerated at the drum end.

The three lines in Fig. B1, top to bottom, are for the back end (drum end) of the rope, the middle, which is halfway up or down the rope, and for the front end or kibble end of the rope respectively.

The winder rope was not shortened during the calculations. This is not of importance because the only parts which are of interest here, are the maximum values which were reached less than 2 seconds after the acceleration was applied.

The maximum rope forces shown in Fig. B1 are $353,6 \text{ kN}$ for the back end, $239,6 \text{ kN}$ for the middle of the rope, and $120,8 \text{ kN}$ for the front end. Although a change in rope force of $0,1 \text{ kN}$ is not significant, the extra decimal point will be used in this appendix to illustrate small rope force variations better.

If the total suspended mass of this winder was a rigid body, the force that would have been required to accelerate it at 1 m/s^2 would have been:

$$\text{Force} = \text{total mass} (g + a)$$

$$\begin{aligned} \text{with: } g &= \text{gravitational acceleration (10 m/s}^2\text{)} \\ a &= \text{winder acceleration (1 m/s}^2\text{)} \end{aligned}$$

A force of 330 kN would have been required for the rigid body case, as opposed to the $353,6 \text{ kN}$

calculated for the back end of the rope. This amplification of the effect of the acceleration on the elastic rope with its attached mass can be expressed as follows:

$$Force = mass [g + a(1 + \alpha)]$$

with: $mass$ = total suspended mass
 g = gravitational acceleration (10 m/s²)
 a = winder acceleration (1 m/s²)
 α = dynamic amplification factor

The dynamic amplification factors (or simply the dynamic factors) were calculated for the maximum rope forces shown in Fig. B1. The suspended mass used in the calculations were for the part below the reference point: For the back end it was the total attached mass, for the middle it was half the rope plus the attached mass, and for the front end it was the attached mass only. The dynamic factors that were calculated are:

$$\begin{aligned} \alpha_{back} &= 0,79 \\ \alpha_{middle} &= 0,98 \\ \alpha_{front} &= 1,08 \end{aligned}$$

For a rigid body, $\alpha = 0$, and for a simple mass-spring system with a weightless spring and no damping, $\alpha = 1$. It is of interest to note, for the winder system used here, that the dynamic factor at the front end is slightly greater than 1.

The dynamic amplification of the rope forces shown above is sometimes also referred to as "overshoot". In the example case above the overshoot at the back end of the rope was 79%.

If the winder was descending and decelerated at a rate of 1 m/s², the results would have been identical to that shown above.

The effects of different rates of acceleration, rope stiffness, damping, rope length and attached masses on the dynamic amplification factors are examined and discussed in the section that follows.

B3. CHANGING THE WINDER PARAMETERS

B3.1 Stiffness and acceleration

The "average" elastic modulus of the example calculation shown in section B2 above is in the order of 120 GPa. The rope force calculations were repeated but with a constant rope elastic modulus in stead of one that varies with an applied rope load. Constant values of 60 GPa, 120 GPa, and 180 GPa were used. In each of these cases the (constant) acceleration that was applied during the calculations was changed from 0,5 m/s² to 1 m/s² to 2 m/s².

The maximum rope forces at the back, middle and front end of the rope were extracted from the results and are shown in Table B1. Changing the elastic modulus of the rope will, of course, change the period of the rope force oscillations, but at this point, only the maximum rope forces are of interest.

To put the calculated values of Table B1 into perspective: A change of 0,1 in the value of the dynamic factor (α) will, at an acceleration of 1 m/s², corresponds to a change in the force at the

back end of 3 kN and at the front end of 1 kN.

Table B1: The effect on the calculated rope forces of varying the rope elastic modulus and the applied drum acceleration (Damping factor: $\beta = 0,025$ s)

Position on rope	Rope force (kN)	α	Rope force (kN)	α	Rope force (kN)	α	Applied acceleration
back	327,2	0,81	326,8	0,79	326,6	0,77	a = 0,5 m/s ²
middle	220,1	1,01	219,8	0,98	219,7	0,97	
front	110,7	1,14	110,4	1,08	110,3	1,06	
back	354,4	0,81	353,6	0,79	353,1	0,77	a = 1 m/s ²
middle	240,2	1,01	239,7	0,99	239,3	0,97	
front	121,3	1,13	120,9	1,09	120,6	1,06	
back	408,8	0,81	407,3	0,79	406,2	0,77	a = 2 m/s ²
middle	280,4	1,01	279,4	0,99	278,7	0,79	
front	142,7	1,14	141,8	1,09	141,2	1,06	
Rope modulus	E = 60 GPa		E = 120 GPa		E = 180 GPa		

The results in Table B1 show that the applied acceleration does not have an influence on the values of the dynamic amplification factor, α . The α 's for a constant rope modulus of 120 GPa are the same as those that were obtained using the rope load dependent modulus. The α 's for E = 60 GPa is slightly higher than the others, but then such a low average rope modulus is unlikely.

The damping constant as defined earlier in this appendix is coupled to the elastic modulus of the rope. The influence of varying both the modulus and the damping constant, at an acceleration of 1 m/s², is shown in Table B2.

As expected, the maximum rope forces (and resulting dynamic factors) decrease as the damping constant increases. The variation of the damping constant in Table B2 (halve and double) from the experimentally determined value of $\beta = 0,025$ s is quite severe, but the variation in the rope forces is not very significant. The actual variation of the damping constant from one rope to the next would more likely be in the range of 0,02 s to 0,03 s.

The results from the variation in rope elastic modulus and rope damping constant in this section show that it is acceptable to calculate the peak rope forces using a constant elastic modulus of 120 GPa and a damping constant (β) of 0,025 s.

Table B2: The effect on the calculated rope forces of varying the rope elastic modulus and the damping constant, β . (winder acceleration = 1 m/s^2)

Position on rope	Rope force (kN)	α	Rope force (kN)	α	Rope force (kN)	α	Damping constant
back	355,3	0,84	354,9	0,83	354,6	0,82	$\beta = 0,0125 \text{ s}$
middle	240,9	1,05	240,6	1,03	240,4	1,02	
front	122,2	1,22	121,8	1,18	121,5	1,15	
back	354,4	0,81	353,6	0,79	353,1	0,77	$\beta = 0,025 \text{ s}$
middle	240,2	1,01	239,7	0,99	239,3	0,97	
front	121,3	1,13	120,9	1,09	120,6	1,06	
back	352,7	0,76	351,5	0,72	350,6	0,69	$\beta = 0,05 \text{ s}$
middle	239,1	0,96	238,2	0,91	237,6	0,88	
front	120,4	1,04	119,9	0,99	119,6	0,96	
Rope modulus	E = 60 GPa		E = 120 GPa		E = 180 GPa		

B3.2 Rope length and attached mass

The 10 kg/m rope used in the calculations in the preceding sections of this appendix was again used in the calculations of which the results follow. The suspended rope length was varied from 250 m to $3\,750 \text{ m}$ and the mass attached at the end of the rope was varied from $2\,500 \text{ kg}$ to $37\,500 \text{ kg}$. A constant acceleration of 1 m/s^2 was applied at the drum end in all cases. The maximum rope forces at the back, middle and front end of the rope was extracted from the calculated rope forces and the dynamic amplification factor (α) was calculated for each case. These values are shown in Tables B3, B4 and B5.

The results in Tables B3, B4 and B5 show that the ratio between the suspended rope mass and the attached mass has no noticeable influence on the resulting maximum rope forces. This is further illustrated in Fig. B2 below. The thicker line represents a $3\,500 \text{ m}$ rope with a $5\,000 \text{ kg}$ mass attached at the end, and the thinner line represents a 500 m rope with a $35\,000 \text{ kg}$ mass attached. In both cases the total mass was $40\,000 \text{ kg}$. Although the period of the rope force variations are different, the maximum rope forces are virtually the same.

Table B3: Dynamic amplification factors at the **back end** of a rope for different suspended lengths and attached masses.

Dynamic amplification factors (α)								
Suspended rope length	Mass attached at the rope end (kg)							
	2 500	7 500	12 500	17 500	22 500	27 500	32 500	37 500
250 m	0,50	0,66	0,73	0,77	0,80	0,82	0,83	0,84
750 m	0,66	0,72	0,77	0,81	0,83	0,85	0,86	0,87
1 250 m	0,72	0,75	0,76	0,80	0,83	0,85	0,85	0,86
1 750 m	0,76	0,78	0,78	0,77	0,81	0,84	0,86	0,87
2 250 m	0,78	0,80	0,80	0,79	0,78	0,81	0,84	0,86
2 750 m	0,80	0,82	0,81	0,80	0,79	0,78	0,81	0,84
3 250 m	0,82	0,83	0,83	0,82	0,81	0,79	0,79	0,81
3 750 m	0,83	0,84	0,84	0,83	0,82	0,81	0,80	0,79

The shaded diagonal in Table B3 are for the same total suspended mass of 40 000 kg. Any diagonal of the table parallel to the shaded one will represent a constant total suspended mass.

Table B4: Dynamic amplification factors at the **middle** of a rope for different suspended lengths and attached masses.

Dynamic amplification factors (α)								
Suspended rope length	Mass attached at the rope end (kg)							
	2 500	7 500	12 500	17 500	22 500	27 500	32 500	37 500
250 m	0,63	0,74	0,79	0,81	0,83	0,85	0,86	0,87
750 m	0,86	0,88	0,90	0,91	0,91	0,92	0,92	0,93
1 250 m	0,93	0,94	0,95	0,94	0,95	0,95	0,95	0,95
1 750 m	0,96	0,97	0,97	0,97	0,97	0,97	0,97	0,97
2 250 m	0,98	0,99	0,99	0,99	0,99	0,99	0,98	0,98
2 750 m	0,99	1,00	1,01	1,01	1,00	1,00	1,00	0,99
3 250 m	0,99	1,00	1,02	1,02	1,01	1,01	1,01	1,01
3 750 m	1,00	1,00	1,02	1,03	1,02	1,02	1,01	1,01

Table B5: Dynamic amplification factors at the **front end** of a rope for different suspended lengths and attached masses.

Dynamic amplification factors (α)								
Suspended rope length	Mass attached at the rope end (kg)							
	2 500	7 500	12 500	17 500	22 500	27 500	32 500	37 500
250 m	0,68	0,77	0,80	0,83	0,84	0,86	0,87	0,87
750 m	0,94	0,96	0,94	0,94	0,95	0,95	0,95	0,95
1 250 m	0,98	1,04	1,04	1,02	0,99	0,98	0,99	0,99
1 750 m	1,00	1,05	1,10	1,09	1,06	1,03	1,00	1,00
2 250 m	1,00	1,05	1,12	1,14	1,12	1,10	1,06	1,03
2 750 m	1,00	1,04	1,12	1,15	1,16	1,15	1,12	1,09
3 250 m	1,00	1,03	1,11	1,16	1,18	1,18	1,16	1,14
3 750 m	1,00	1,03	1,10	1,16	1,19	1,20	1,19	1,17

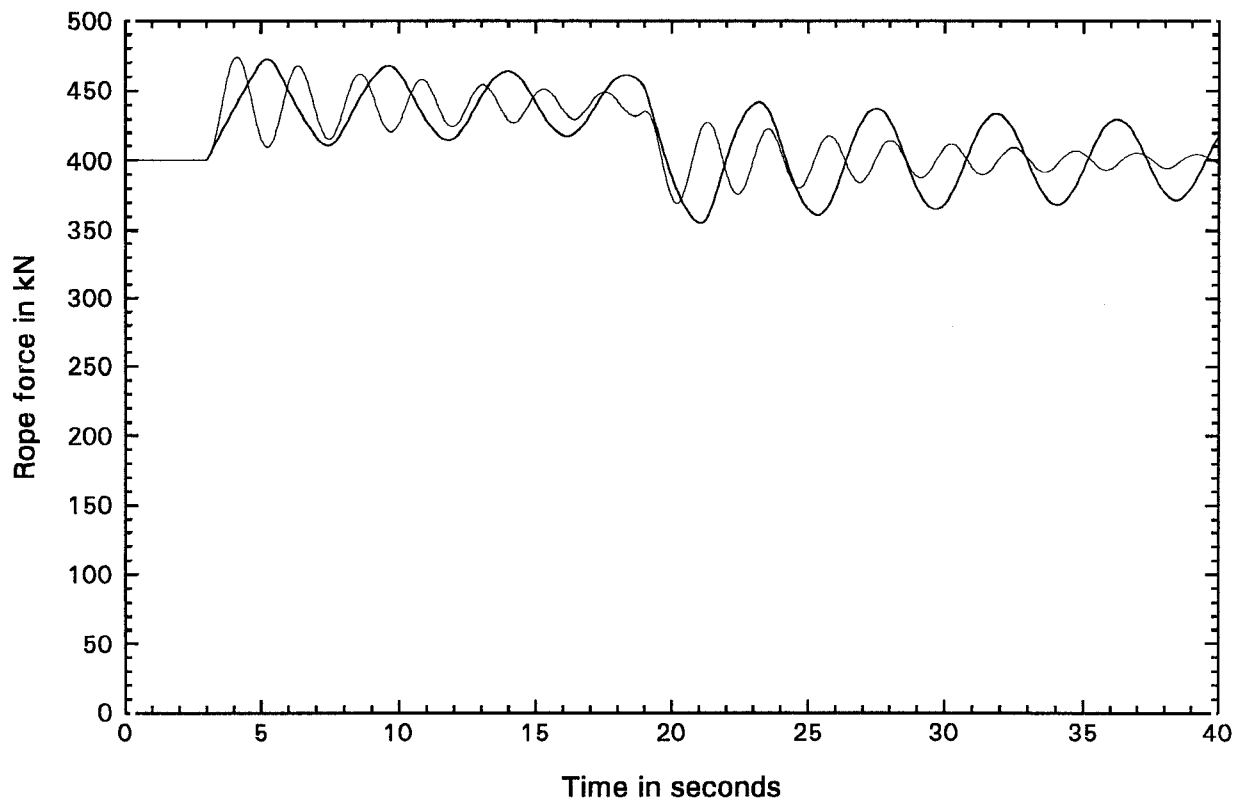
**Figure B2:** Back end rope forces for the same rope size and the same total suspended mass, but different ratios between the rope mass and the mass attached at the rope end.

The results in the tables above also show that the behaviour of a short rope with relatively light mass ($\alpha_{\text{back}} = 0,5$) is more towards that of a rigid body.

The attached masses to the lower right hand corners of Tables B3, B4 and B5 are too large for practical winder installations. The following values of the dynamic amplification factor (α) will either give conservative (over-estimated) or correct values for the rope forces:

$$\begin{aligned}\alpha_{\text{back}} &= 0,85 \\ \alpha_{\text{middle}} &= 1,00 \\ \alpha_{\text{front}} &= 1,15\end{aligned}$$

B3.3 Changing the rope size and properties

All the calculations in this appendix were performed using the same rope, i.e. a rope with a cross sectional area of 1 110 mm² and a mass of 10 kg/m. Tensile grade and rope strength do not influence the calculation of rope forces. Different rope sizes with appropriately proportioned attached masses would have resulted in the same dynamic amplification factors as calculated in the previous sections.

B3.4 Changing gravitational acceleration

A change in the value of the gravitational acceleration (g), as would be the case for an inclined winder, does not change the values of the calculated dynamic amplification factors.

B3.5 Ramped acceleration

The rope dynamics resulting from the (constant) acceleration applied at the drum end can be reduced largely if the drum acceleration is ramped (a gradual increase with time) instead of applied or introduced instantaneously.

The natural period of oscillation of the example case shown in Fig. B1 is 3,3 seconds. If the acceleration is increased linearly from zero to the constant value (in this case 1 m/s²) in exactly 3,3 seconds, the rope dynamics are eliminated as illustrated in Fig. B3 below. The rope dynamics at the end of the acceleration period are caused by the abrupt (instantaneous) removal of the acceleration. These dynamics can also be eliminated (or reduced) by a gradual decrease in the acceleration at the end of the acceleration period.

Practically, accelerations cannot be applied instantaneously. Figure B4 below shows the rope forces generated when the acceleration is increased linearly over a 1 second period, and Fig. B5 when this period is 4,3 seconds.

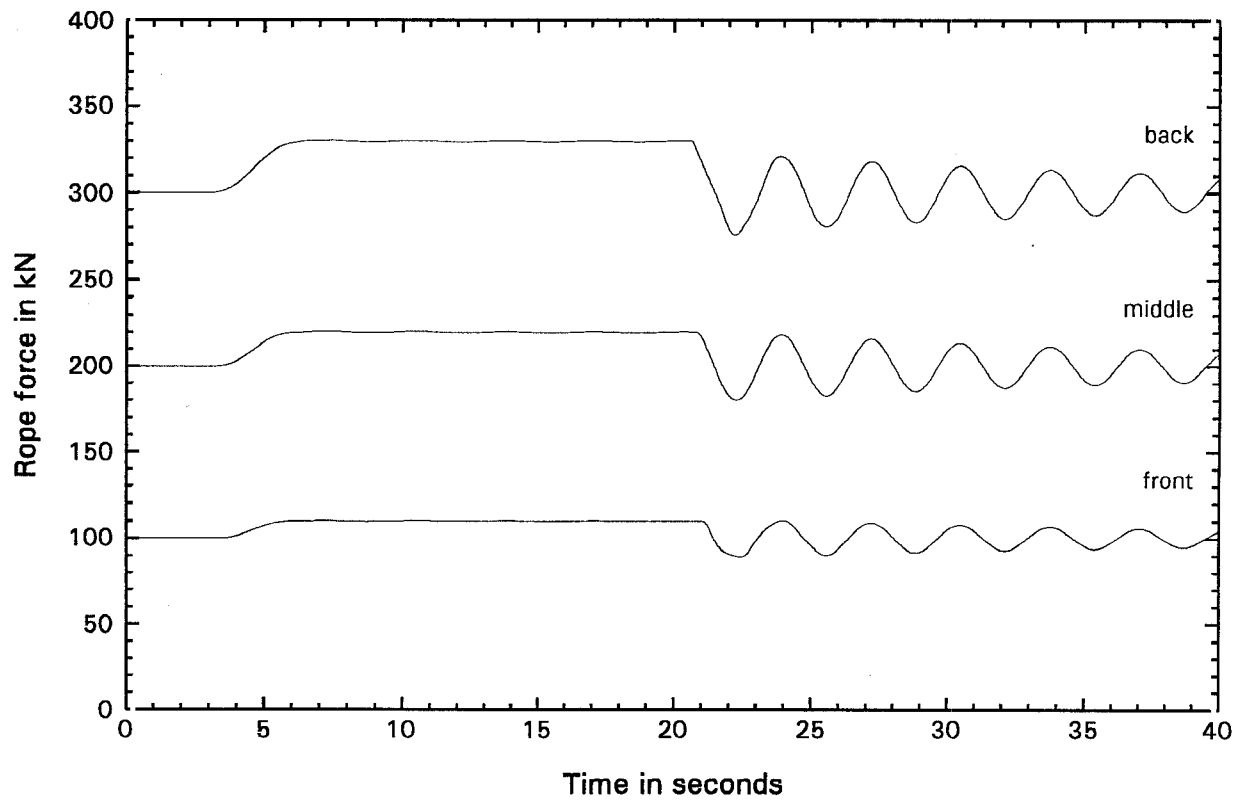

Figure B3: The winder acceleration is increased linearly, from zero to 1 m/s^2 , over a period equal to the natural period of the winder system, and later removed abruptly.

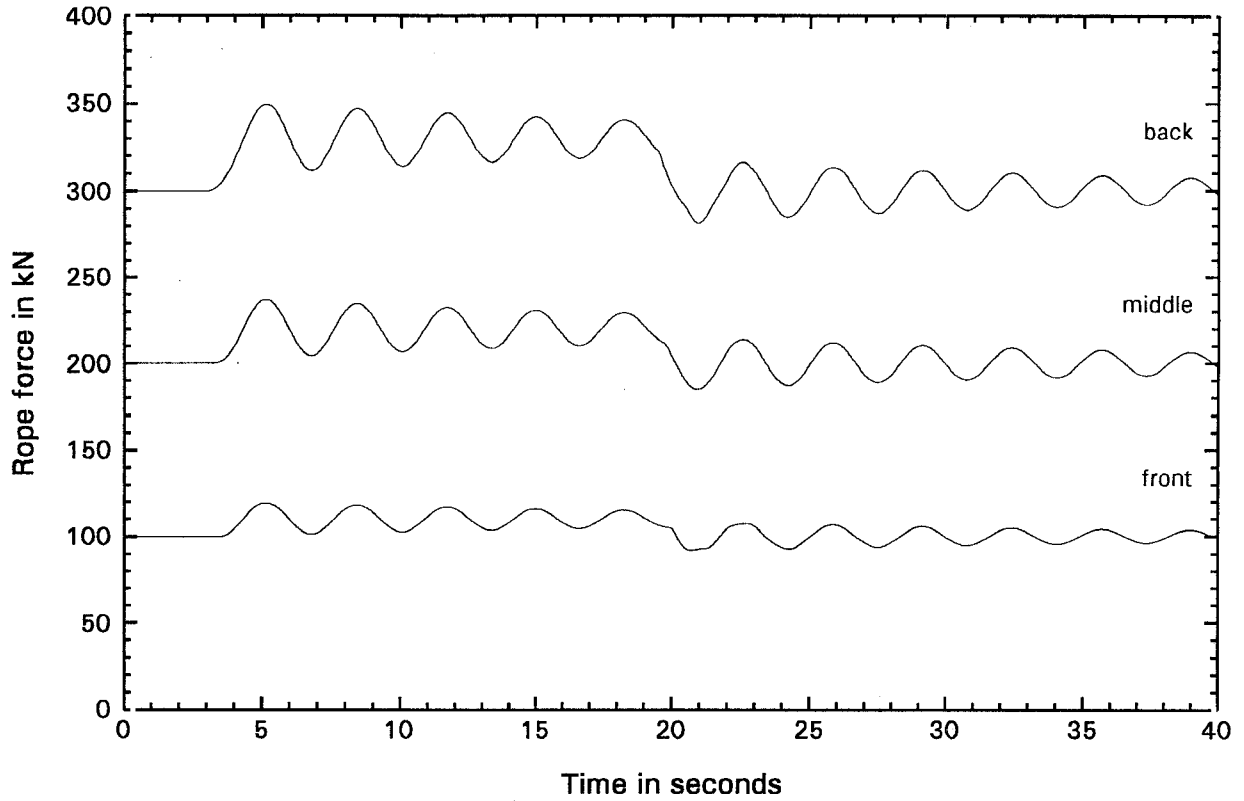

Figure B4: Acceleration increased linearly from zero to 1 m/s^2 over a 1 second period, and later removed abruptly.

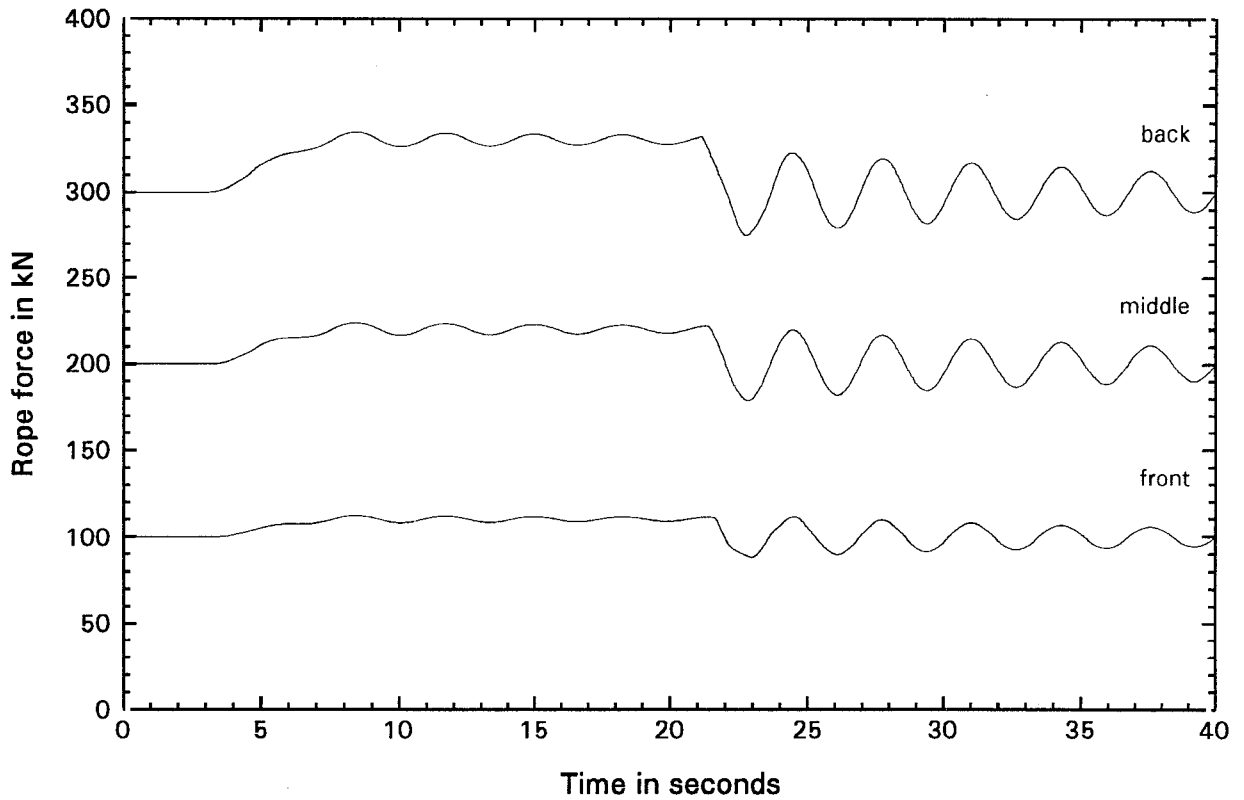

Figure B5: Acceleration increased linearly from zero to 1 m/s^2 over a 4,3 second period, and later removed abruptly.

The dynamic amplification factors for the two cases shown in the figures above are:

Acceleration increased linearly
from zero to the constant value
over a 1 second period:

$$\begin{aligned}\alpha_{\text{back}} &= 0,65 \\ \alpha_{\text{middle}} &= 0,84 \\ \alpha_{\text{front}} &= 0,93\end{aligned}$$

Acceleration increased linearly
from zero to the constant value
over a 4,3 second period:

$$\begin{aligned}\alpha_{\text{back}} &= 0,14 \\ \alpha_{\text{middle}} &= 0,19 \\ \alpha_{\text{front}} &= 0,21\end{aligned}$$

It should be kept in mind that ramping the acceleration, but maintaining the maximum (constant) value of the acceleration, will require a longer acceleration period to reach full winding speed than when the acceleration is applied instantaneously.

B4. SUMMARY

In this appendix it was shown that the maximum rope force in a drum winder rope, generated when an acceleration is applied at the drum end, is given by the following equation:

$$\text{Force} = \text{mass} [g + a(1 + \alpha)]$$

with: $mass$ = suspended mass
 g = gravitational acceleration
 a = acceleration at the drum end
 α = dynamic amplification factor

The "suspended mass" in the equation above is the total of the masses suspended below the point on the rope at which the rope forces are calculated.

If the acceleration at the drum end is applied instantaneously, the following dynamic amplification factors are applicable:

$$\begin{aligned}\alpha_{\text{back}} &= 0,85 \\ \alpha_{\text{middle}} &= 1,00 \\ \alpha_{\text{front}} &= 1,15\end{aligned}$$

In real life the drum acceleration would not be applied instantaneously, but it is more likely that at least 1 second would elapse before the acceleration would reach its constant value. The results of the complete analysis of the rope forces generated when the acceleration at the drum end increases linearly over a 1 second period and then kept constant are not shown in this appendix, but the following conservative values for the dynamic factors were obtained:

$$\begin{aligned}\alpha_{\text{back}} &= 0,80 \\ \alpha_{\text{middle}} &= 0,95 \\ \alpha_{\text{front}} &= 1,05\end{aligned}$$

These dynamic factors will yield more realistic rope forces than the dynamic amplification factors for instantaneously applied accelerations.

APPENDIX C: MASS AND STRENGTH OF NON-SPIN ROPES

Rope strength and rope mass are the critical parameters when rope safety factors are calculated for a winder installation, because, apart from the mass suspended at the rope end, a rope has to support its own weight.

Formulae for rope strength and rope mass are given in this appendix with which the values listed in the *Haggie Rand Rope Catalogue* (November 1987) can be approximated.

Kibble winders at shaft sinking installations have to use non-spin ropes because the front end of a kibble rope is free to rotate. The information in this appendix therefore concerns non-spin ropes only.

C1. CROSS-SECTIONAL STEEL AREA

According to the *Haggie Rand Rope Catalogue*, the cross-sectional steel area of a non-spin ropes is given by the following equation:

$$A = 0,5 d^2$$

with: A = cross-sectional steel area of the rope
 d = diameter of the rope

The cross-sectional steel area is the sum of the cross-sectional areas of all the wires in a rope.

C2. ROPE MASS

The rope mass (per metre) of all 15 strand non-spin ropes (ribbon and fishback) and all 18 strand non-spin ropes (fishback) in the Haggie Catalogue were analysed.

The following equation for the rope mass per unit rope length was obtained:

$$m_m = \rho A$$

with: m_m = rope mass per unit length
 ρ = 9 100 kg/m³: the bulk density
 A = cross-sectional steel area of the rope

The rope mass values for some of the 15 strand non-spin ropes with ribbon strands could be under-estimated by one to two percent. The mass of the other rope construction could be over-estimated by one to two percent.

The mass of a length, L , of rope, m_{rope} , is obtained by multiplying the rope mass per unit length by the length of rope. This gives:

$$m_{rope} = \rho A L$$

C3. ROPE STRENGTH

The listed rope strength of all 15 strand non-spin ropes (ribbon and fishback) and all 18 strand non-spin ropes (fishback) in the Haggie Catalogue were analysed.

The following formula for rope strength was obtained:

$$F_b = \eta \sigma A$$

with: F_b = rope breaking strength
 η = 0,85: the rope efficiency
 σ = tensile grade of the rope
 A = cross-sectional steel area of the rope

The *rope efficiency* of 85% corresponds to a *rope spinning loss* of 15%.

Haggie Rand ropes are always at least as strong as the catalogued values. The average *rope efficiencies* that were obtained from the analyses of the different rope constructions were increased by one to two percent to arrive at the 0,85 in the formula above.

C4. EXAMPLE CALCULATIONS

42 mm diameter 15 strand non-spin rope (9x8/6x29), 1 900 MPa:

Catalogued: 7,981 kg/m and 1 393 kN

Calculated: 8,026 kg/m and 1 424 kN

55 mm diameter 18 strand non-spin rope (12x10/6x29), 2 100 MPa:

Catalogued: 13,67 kg/m and 2 644 kN

Calculated: 13,76 kg/m and 2 700 kN

APPENDIX D: SAFETY FACTOR AND EMERGENCY BRAKING

Appendix B, p. 28 gave the following equation for the maximum rope force generated when a winder with a rope and attached mass is decelerated while descending:

$$F_{max} = m_{total} [g + a(1 + \alpha)]$$

with:

F_{max}	=	maximum rope force
m_{total}	=	rope mass plus suspended mass
g	=	gravitational acceleration
a	=	constant deceleration at the drum end
α	=	dynamic amplification factor

For the same deceleration rate, the maximum rope force will have its largest value when the total mass is the largest, i.e. near the bottom of the shaft. In the calculations that follow, the largest mass will be based on the maximum length of suspended rope in the shaft.

Limiting the maximum rope force to a certain fraction of the rope breaking strength gives:

$$F_{max} = \Delta F_{break}$$

with:

F_{break}	=	the breaking strength of the rope
Δ	=	allowable fraction

The (static) rope safety factor (f_{SF}) is by definition:

$$f_{SF} = \frac{F_{break}}{m_{total} g}$$

Substituting the two equations above into the first equation, and rearranging, gives the maximum rope force as a fraction of the rope breaking strength and in terms of the (static) safety factor and the winder dynamics during emergency braking:

$$\Delta = \frac{1}{f_{SF}} \left[1 + \frac{a}{g} (1 + \alpha) \right]$$

For a given, or allowable fraction, the equation can be rearranged to give a required rope safety factor:

$$f_{SF} = \frac{1}{\Delta} \left[1 + \frac{a}{g} (1 + \alpha) \right]$$

The permissible winder deceleration rate can also be expressed in terms of the winder dynamics behaviour, rope safety factor, and allowable fraction:

$$a = \frac{g}{1 + \alpha} (f_{SF} \Delta - 1)$$

If the winder deceleration shape is such that $\alpha = 0,85$ (the maximum value for when the brakes are applied instantaneously), then with a deceleration rate of 4 m/s^2 and a safety factor of 4,5 the maximum rope force will be 39% of the breaking strength of the rope.

The drum winder code of practice allows 40% of the breaking strength of the rope.

For both permanent drum winder installations and kibble winders that do not have to comply with a code of practice, the upper limit of the deceleration of 4 m/s^2 during emergency braking is a reasonable assumption. The safety factor limit of 4,5 is therefore adequate to prevent winder rope overloads.

APPENDIX E: FURTHER APPROXIMATIONS OF THE SHAPE OF KIBBLE WINDER SAFETY FACTORS

Three cases of the approximation of the *required shape* of the safety factor by constant capacity factors of 8 and 9 are shown in Figs 7, 8, and 9, pages ? to ?. The other six combinations of winder acceleration and rope tensile grades are shown here.

Figures E1 and E2: 1 800 MPa ropes for winder accelerations of 0,6 m/s² and 0,8 m/s².

Figures E3 and E4: 2 000 MPa ropes for winder accelerations of 0,6 m/s² and 1,0 m/s².

Figures E5 and E6: 2 200 MPa ropes for winder accelerations of 0,8 m/s² and 1,0 m/s².

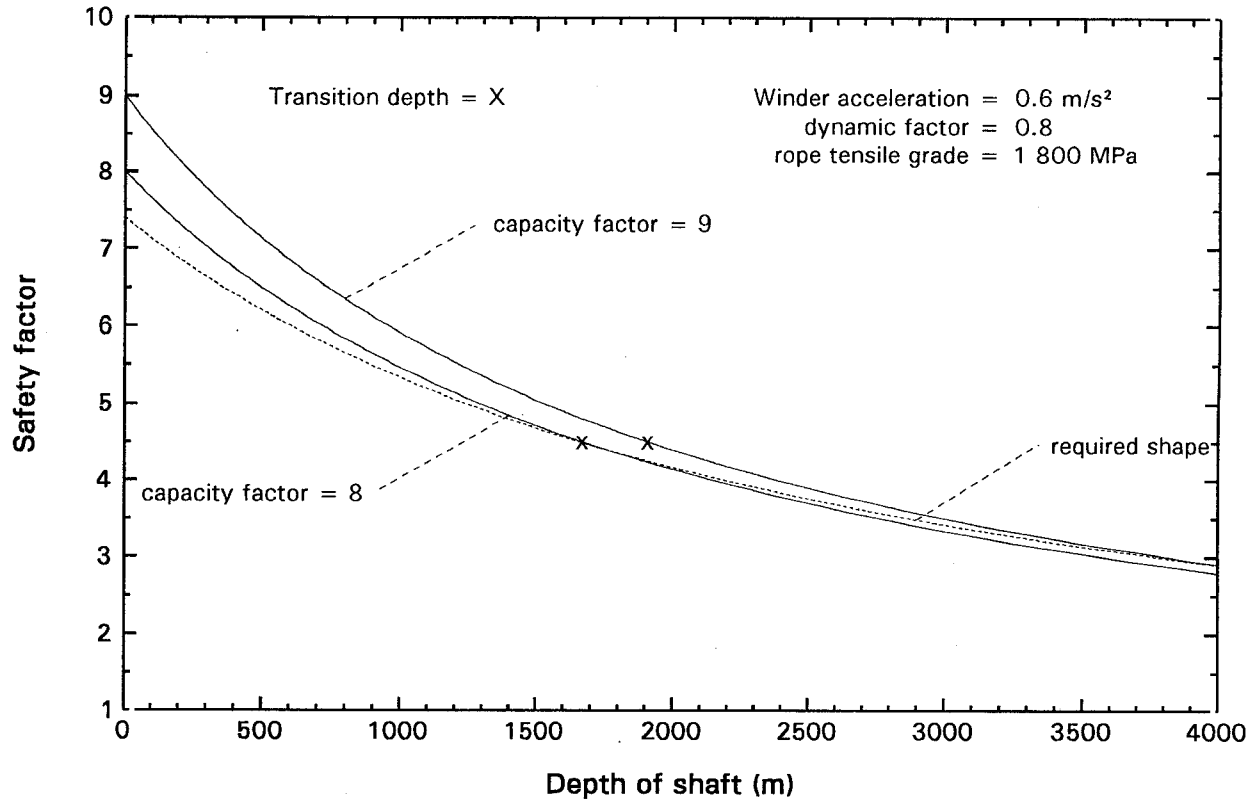

Figure E1: Comparison of the capacity factor approach and the required shape of the safety factor for kibble winders, 1 800 MPa ropes.

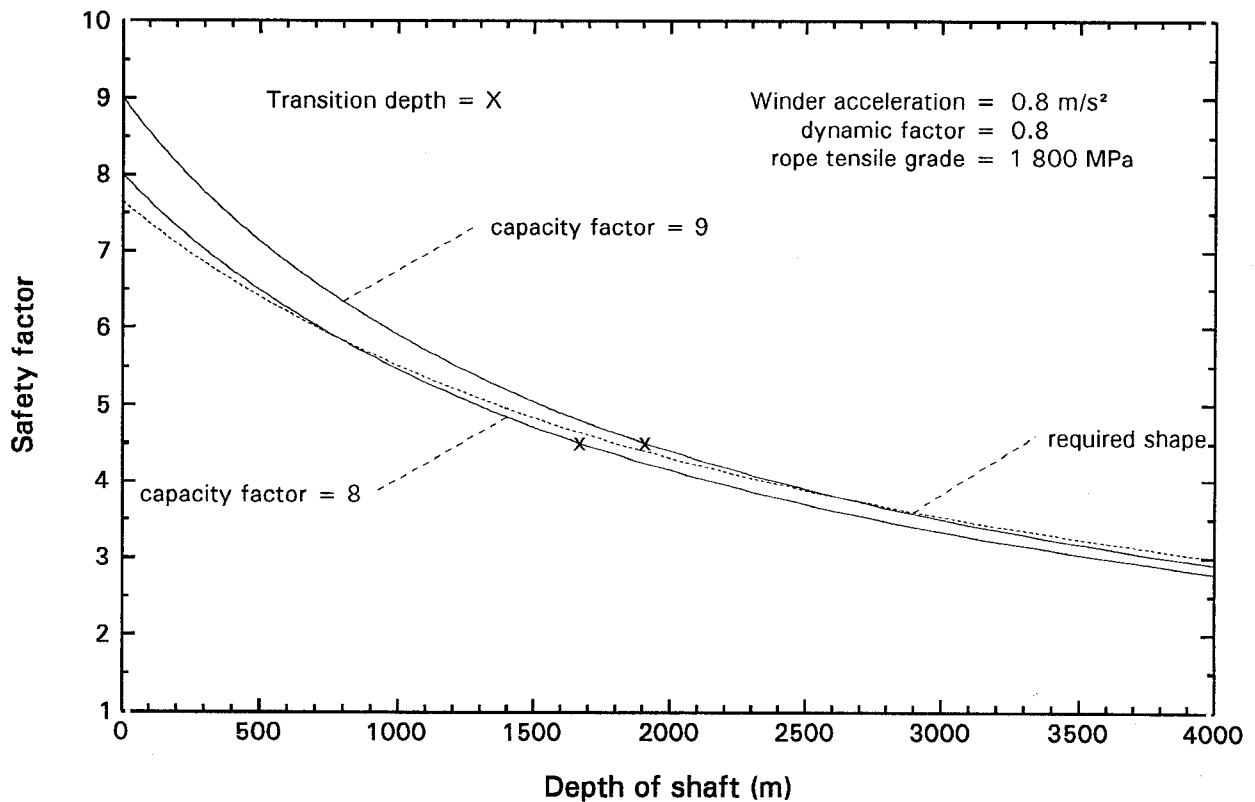

Figure E2: Comparison of the capacity factor approach and the required shape of the safety factor for kibble winders, 1 800 MPa ropes.

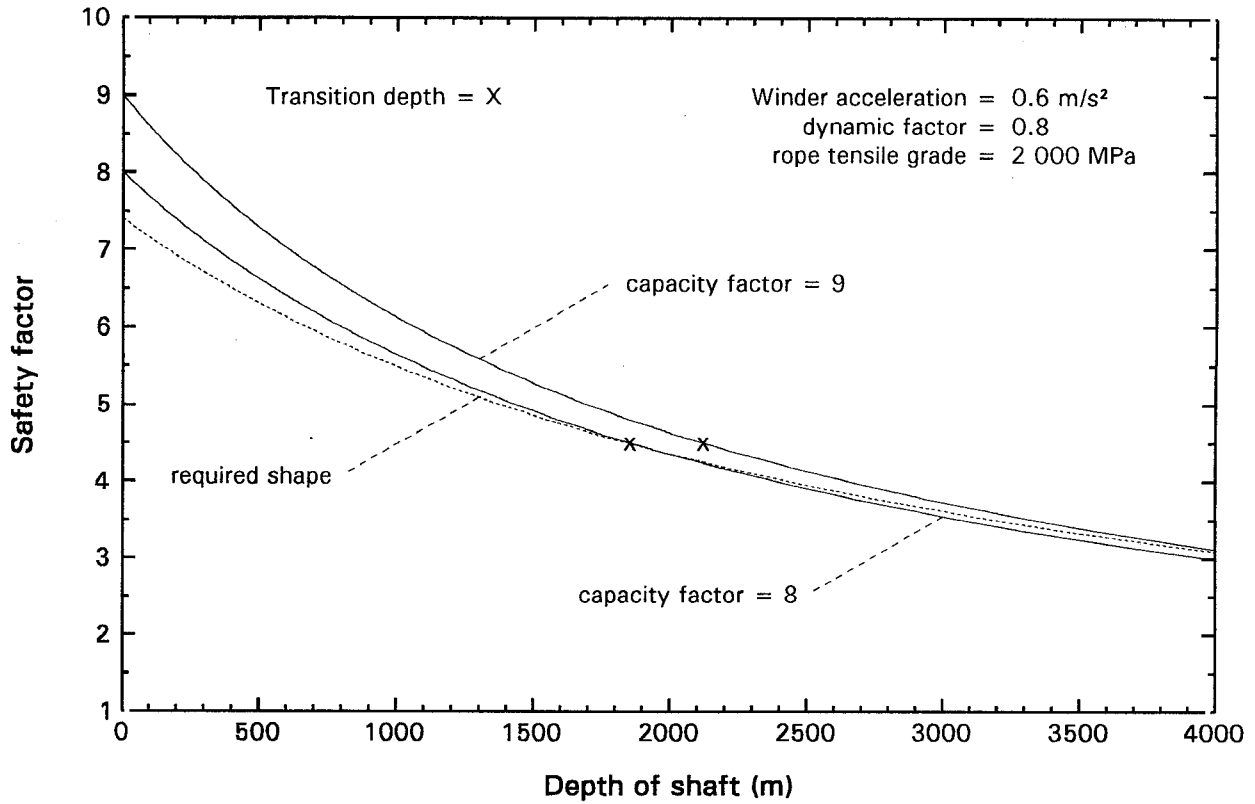

Figure E3: Comparison of the capacity factor approach and the required shape of the safety factor for kibble winders, 2 000 MPa ropes.

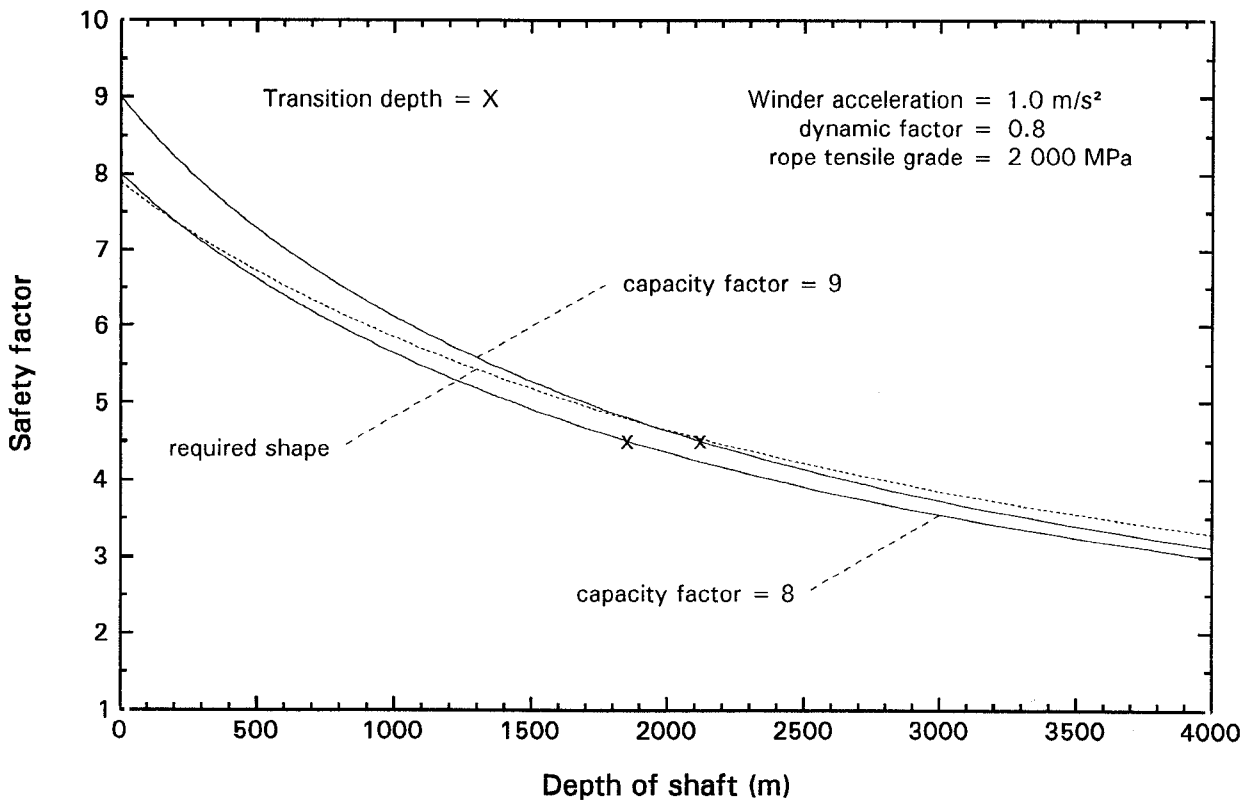

Figure E4: Comparison of the capacity factor approach and the required shape of the safety factor for kibble winders, 2 000 MPa ropes.

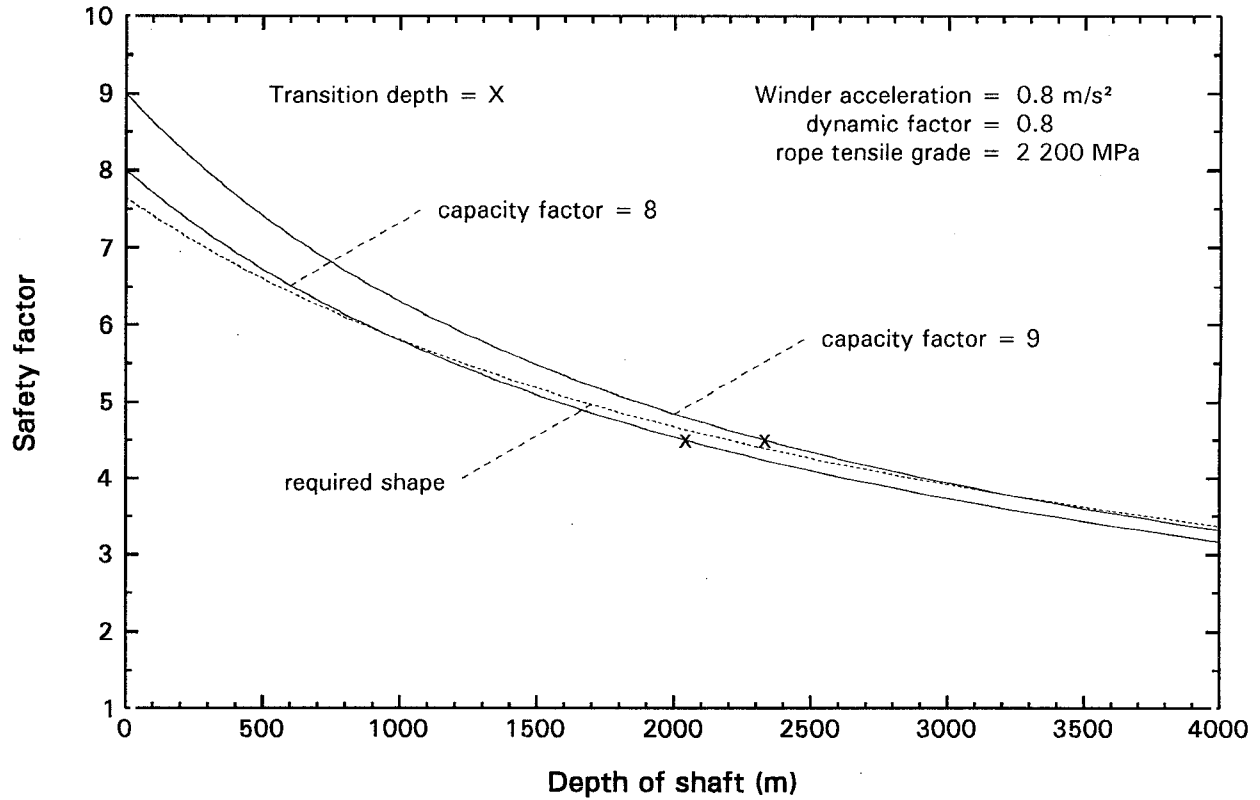

Figure E5: Comparison of the capacity factor approach and the required shape of the safety factor for kibble winders, 2 200 MPa ropes.

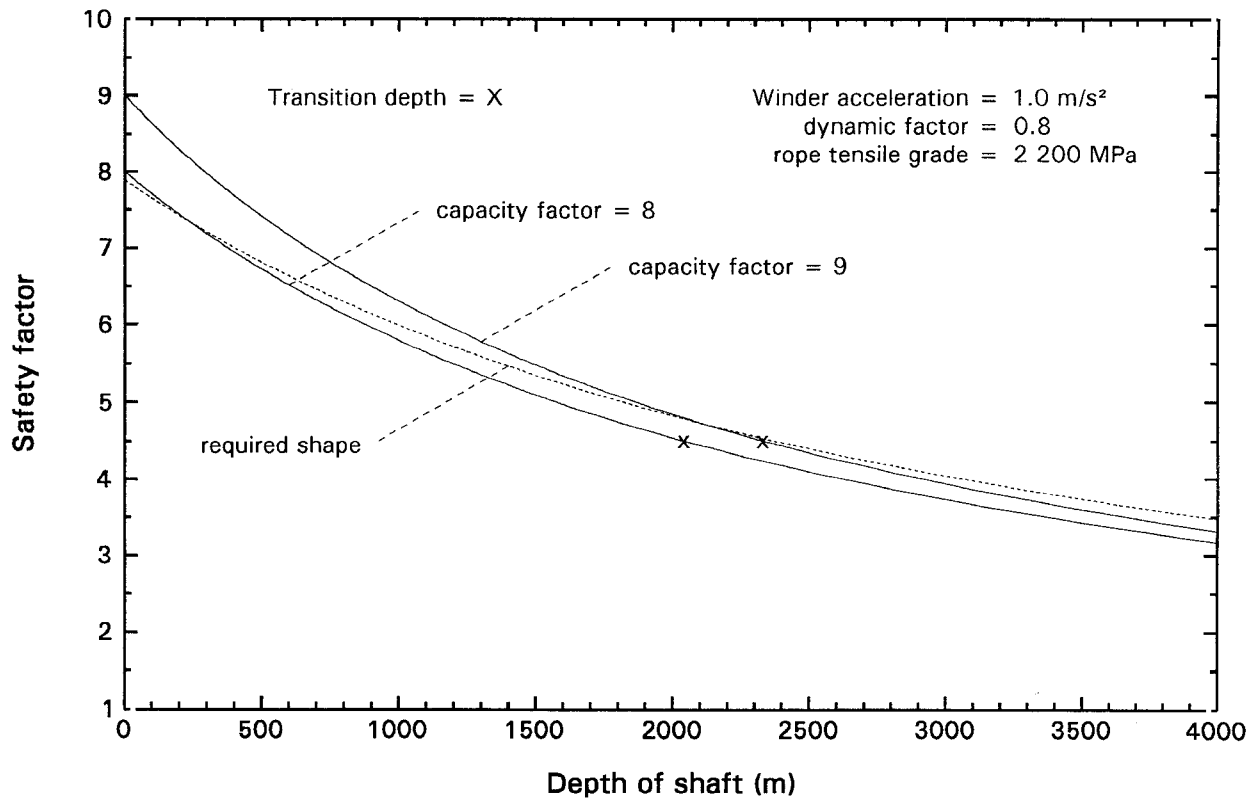

Figure E6: Comparison of the capacity factor approach and the required shape of the safety factor for kibble winders, 2 200 MPa ropes.

APPENDIX F: LOAD RANGE FROM MEASURED ROPE FORCES

The measurement of kibble winder ropes forces and the results of these measurements are discussed in detail in the three reports.^{4,5,6}

F1. WINDER AND ROPE DATA

Winder and rope data for the three sinking installations are given in Table F1. The maximum length of suspended rope in the table is as it was at the time of the rope force measurements. The safety factor in the table was calculated using this value.

The Vaal Reefs shaft had two kibble winder, designated "rock winder" and "man winder".

Table F1: Winder and rope data

	Vaal Reefs 11 Shaft		West Driefontein 10 Shaft	West Driefontein 11 Shaft
	Rock winder	Man winder		
Maximum length of suspended rope	2 388 m	2 378 m	1 426 m	1 899 m
Loads: kibble and x-head rock	5 740 kg 13 000 kg	5 740 kg 14 000 kg	4 400 kg 10 800 kg	5 260 kg 18 000 kg
Rope: diameter	54 mm	54 mm	49 mm	54 mm
tensile grade	1 900 MPa	1 900 MPa	1 800 MPa	1 800 MPa
mass per metre	13,07 kg/m	13,07 kg/m	10,9 kg/m	13,20 kg/m
breaking strength	2 410 kN	2 430 kN	1 890 kN	2 340 kN
Safety factor	4,92	4,88	6,27	4,94
Capacity factor	13,12	12,56	12,69	10,27
Normal winding acceleration rate	0,75 m/s ²	0,55 m/s ²	0,80 m/s ²	0,70 m/s ²

F2. RESULTS OF LOAD RANGE RATIO CALCULATIONS

The method for calculating load range ratios is given in section 7.2, p. 24.

A winding cycle was selected to be completed every time that the overlay rope of the kibble winder passed a point 20 m below the bank while ascending. (Any other point in the shaft could also have been selected.)

F2.1 Vaal Reefs 11 Shaft

The load range ratios for the two Vaal Reefs winders are shown in Figs F1 and F2. The small ellipses show the load range ratio for every winding cycle, and are positioned at the time that that specific load range ratio occurred.

When the measurements were carried out at Vaal Reefs, they were busy with station development and no rock hoisting took place. Men, material and water were conveyed. The largest load range on the underlay rope on the "rock" winder occurred when emergency braking was done while a kibble filled with water descended on that rope. This was also the case for the underlay rope of the "man" winder.

F2.2 West Driefontein 10 Shaft

The load range ratios for the West Driefontein 10 Shaft kibble winder are shown in Fig. F3. Rock was hoisted on both ropes during the first 6 hours and again during the period 14 hr to 23 hr. The largest load range ratio on the overlay rope occurred when emergency braking was done while a kibble filled with rock descended on that rope.

The load range ratios during rock hoisting generally varied between 10% and 12%.

The theoretical load range ratio for this winder calculated with Eqn 22, p. 17, is 10,2%. This calculation assumed that the "correct" amount of rock was loaded. The accuracy of the rope force measurements were estimated to be around 1% of the breaking strength of the rope. The load range ratios calculated from the recorded rope forces are therefore of an expected order.

F2.3 West Driefontein 9 Shaft

The load range ratios for the West Driefontein 9 Shaft kibble winder are shown in Fig. F4. Rock was hoisted on both ropes during the period 14 hr to 22½ hr. The largest load range ratio on the underlay rope, as before, also occurred when emergency braking was done while a kibble filled with rock descended on that rope.

The load range ratios during rock hoisting varied between 10% and 12% for the underlay rope, and were always around 10% for the overlay rope.

The theoretical load range ratio for this winder calculated with Eqn 22 is 12,3%. The accuracy of the rope force measurements at West Driefontein 9 Shaft were estimated to be around 1,3% of the breaking strength of the rope. The load range ratios calculated from the recorded rope forces again of an expected order.

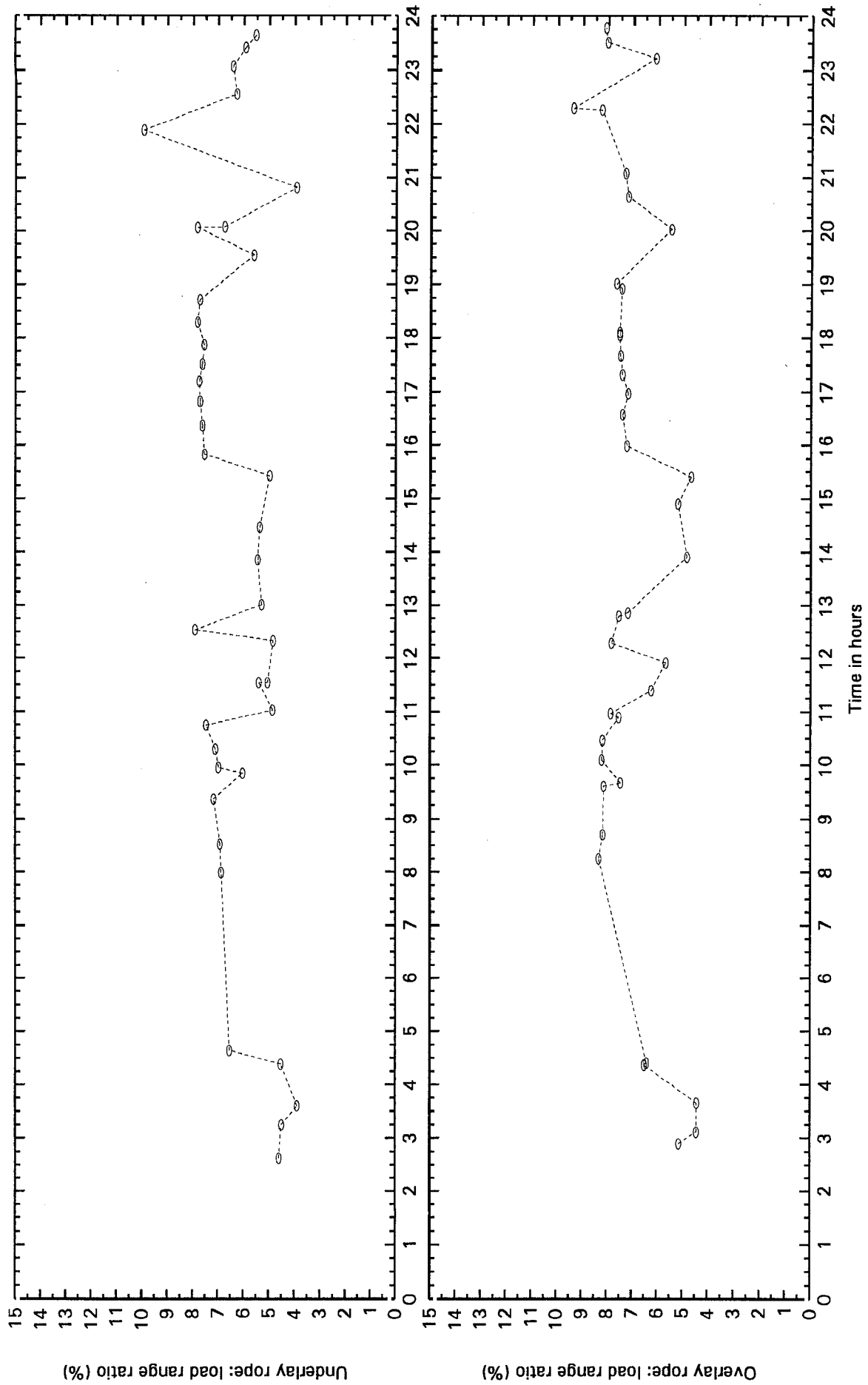

Figure F1: Load range ratios for the "rock" winder at Vaal Reefs 11 Shaft.

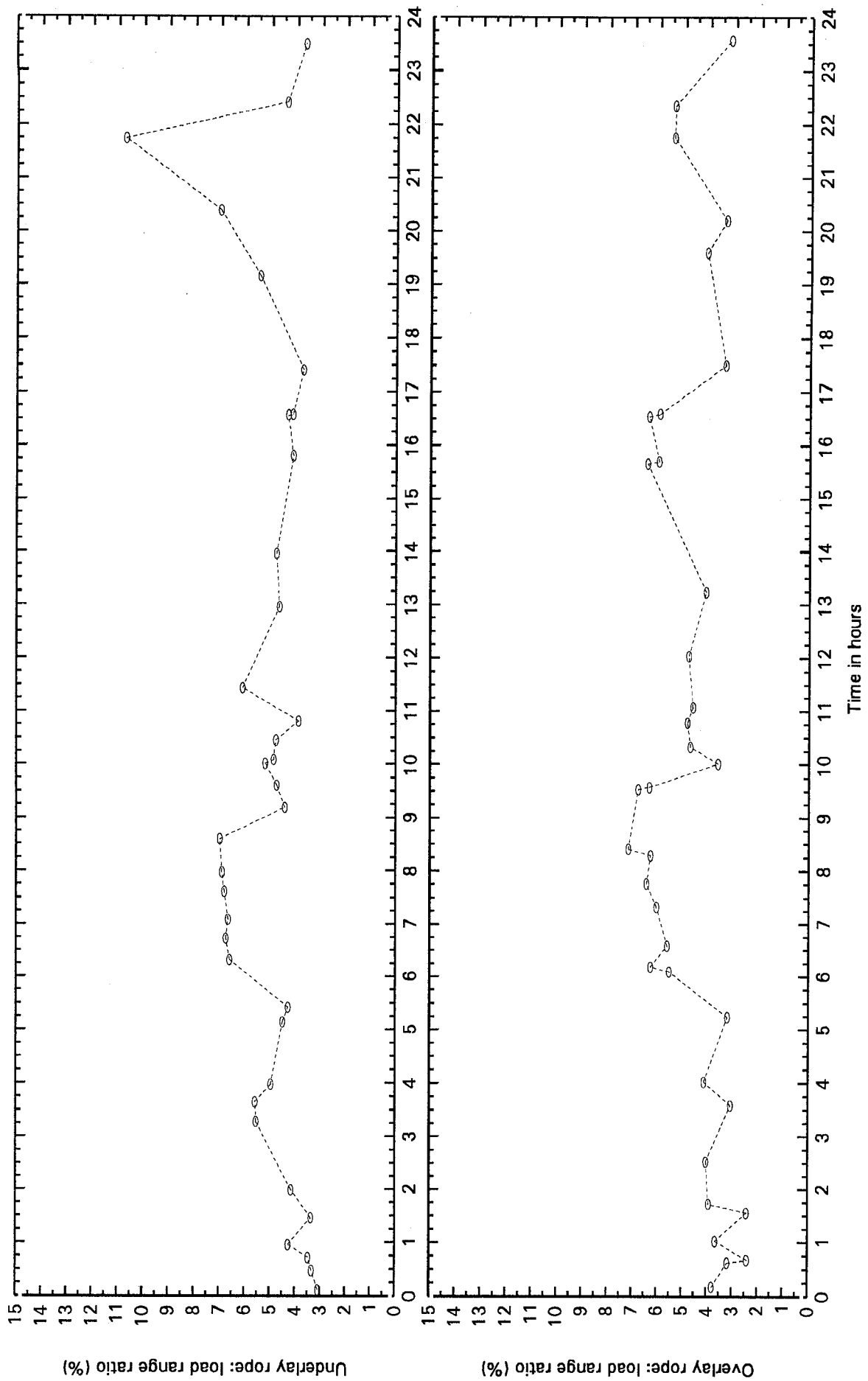

Figure F2: Load range ratios for the "man" winder at Vaal Reefs 11 Shaft.

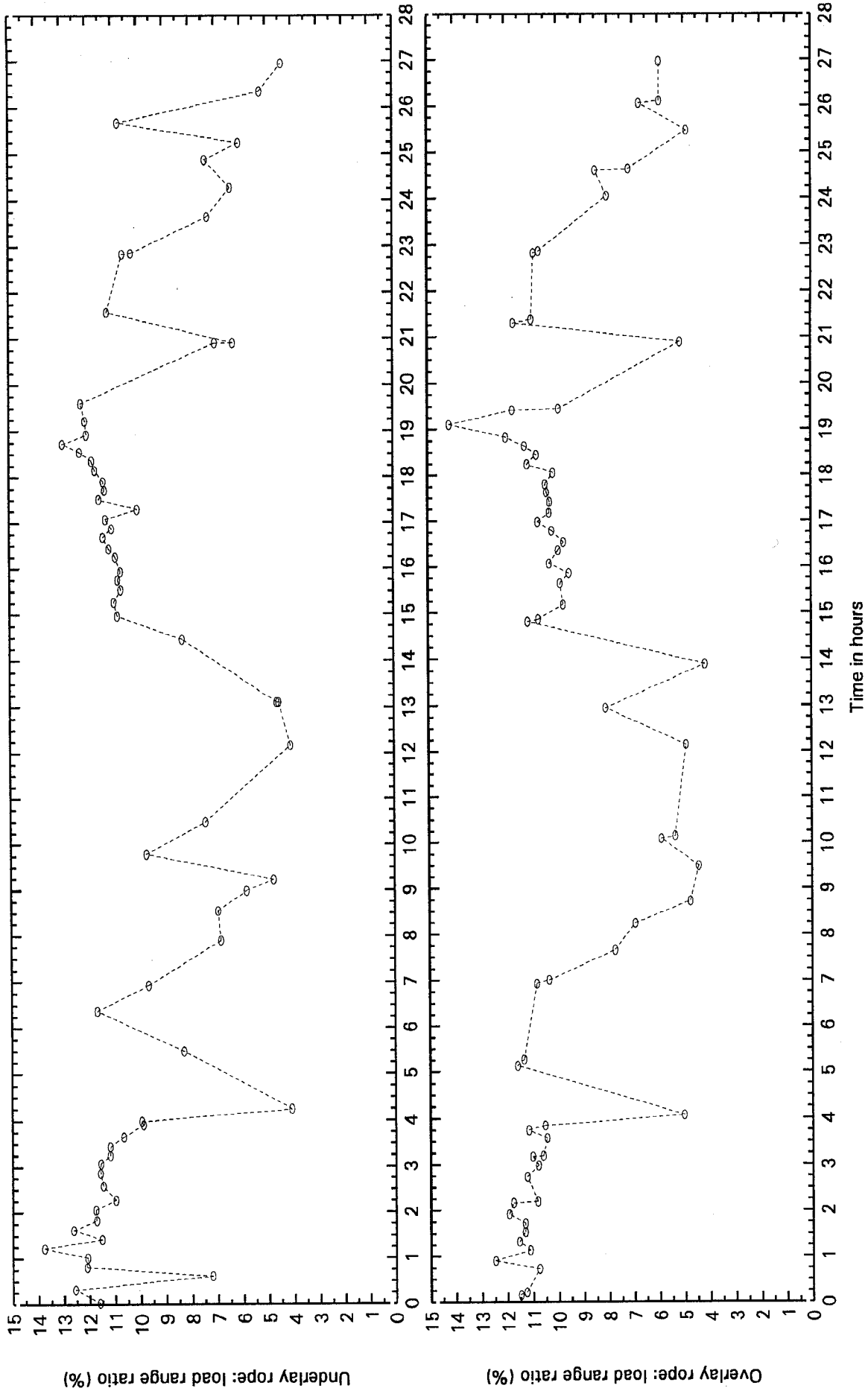

Figure F3: Load range ratios for the kibble winder at West Driefontein 10 Shaft.

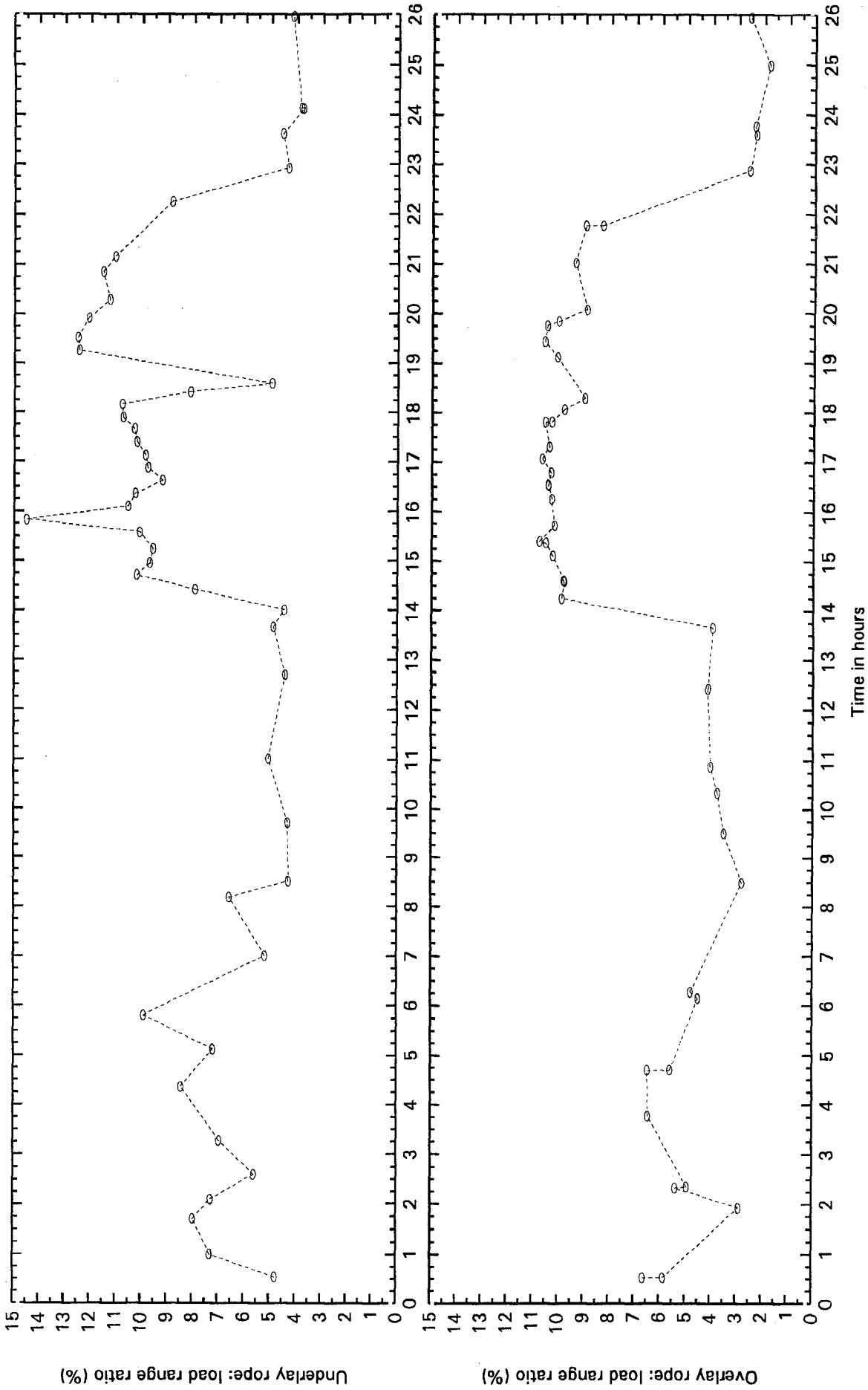

Figure F4: Load range ratios for the kibble winder at West Driefontein 9 Shaft.

Appendix DD: Rope forces generated after brake control failure on kibble winders

CONTENTS

	Page
1. INTRODUCTION	1
2. DEFINITIONS	2
3. ROPE SAFETY CRITERIA DURING BRAKING	3
4. CRITICAL WINDER DECELERATIONS	4
4.1 BRAKING WHILE ASCENDING	4
4.1.1 A selected case	4
4.1.2 The general case	5
4.1.3 The effect of winder speed	6
4.1.4 The effect of winder acceleration before braking	7
4.2 BRAKING WHILE DESCENDING	9
4.2.1 Maximum rope force	9
4.2.2 Slack rope during descending	10
4.2.3 The effect of normal winder deceleration before braking ..	11
4.2.4 The effect of normal winder acceleration before braking ..	13
4.3 SUMMARY OF CRITICAL BRAKING DECELERATIONS	14
5. WINDER DECELERATION AFTER BRAKE CONTROL FAILURE	15
5.1 WINDER BRAKES AND BRAKE CONTROL	15
5.2 WINDER PARAMETERS	15
5.3 BRAKING	16
5.4 DISCUSSION OF THE REQUIRED BRAKE EFFORTS	18
5.5 CASE STUDIES	19
6. CONCLUSIONS AND RECOMMENDATIONS	22
7. REFERENCES	23

APPENDIX A: ROPE FORCE CALCULATIONS	30
A1. THE MODEL	30
A2. ROPE STIFFNESS	30
A3. ROPE DAMPING	31
A4. GENERAL	31
APPENDIX B: MAXIMUM ROPE FORCES DURING EMERGENCY BRAKING	32
APPENDIX C: WINDER BRAKES	34
C1. THE REGULATIONS	34
C2. WINDER BRAKE CAPACITIES	34
C3. WINDER BRAKE CONTROL	35
C4. UNCONTROLLED BRAKING	37
C5. MULTIPLE BRAKE SYSTEMS	38
APPENDIX D: WINDER DRUM INERTIAS	40
APPENDIX E: WINDER MOTOR INERTIAS	43
E1. MOTOR INERTIAS	43
E2. MOTOR POWER AND TORQUE	44

1. INTRODUCTION

The regulations governing the strength of ropes for stage and kibble winders are being investigated under the auspices of a SIMGAP Engineering Advisory Group. The objective of the investigation is to draft regulations and codes of practice that will allow safe sinking operations with stages and kibbles to depths of 4 000 m.

Winder ropes, winder drum sizes, the motors and the capacity of the winder brakes are designed and selected according to the shaft depth and the specific duty that the winder will perform at a shaft. In many cases these permanent winders are also used as kibble winders for the sinking of the shaft. Sinking duties (rock and kibble mass, and rope length) are usually different from the permanent winder duty. During shaft sinking the shaft depth also increases progressively.

Permanent drum winders that will make use of the rope safety factor ($= 25\,000/(4\,000 + L)$) of proposed regulation 16.29.2 will have to comply with the requirements of a code of practice¹. That code requires that the winding rope force during controlled braking will not exceed 40% of the strength of the rope, and that the winder brakes be designed such that the rope force will not exceed 60% of the rope strength during uncontrolled braking. Uncontrolled braking is the result of the failure of any **one** component in the brake system.

The 60% of breaking strength rope force limit was chosen such that, although it will permanently deform the rope at the back end, rope failure will not occur, provided that the rope strength is assessed properly and at appropriate intervals.

The brake capacity of a permanent winder could be greater than that required when the winder performs kibble winding duties. The analyses in this report were carried out primarily to determine how a winder and its ropes will behave when the winder is used for kibble winding duties. The analyses are also applicable to permanent winders, because the brake performance for the permanent duty have to be analysed first, before the behaviour of the same winder for kibble winding duties can be established. Apart from the maximum rope forces that could be generated during brake control failure, this report also investigates what is required to produce slack at the front end of a winder rope.

A further objective of this report was to determine what winder brake requirements have to be included in the code of practice for sinking winders other than those in the winder code of practice¹.

Only the brake torque capacity of the winder brakes are considered in this report. It was assumed that winder brakes could be designed to have adequate thermal capacity.

2. DEFINITIONS

Some of the terms used in this report are defined as follows:

Front end: That end of the rope attached to the kibble, or the section of rope near the kibble end of the rope.

Back end: That end of the rope at or near the drum when the kibble is at its lowest position in the shaft. As a shaft gets deeper, the back end position on the rope changes.

Initial breaking strength: The actual breaking strength of a rope when new. Also called the new rope breaking strength.

Capacity factor: The initial strength of the rope divided by the maximum static load it has to support at its front end.

Safety factor: The initial strength of the rope divided by the maximum static load it has to carry (i.e. the maximum weight that it has to support at its front end plus the weight of the maximum length of the suspended rope). This factor decreases for kibble winder ropes as the depth of the shaft increases.

Permanent installations: Permanent installations refer to those winding systems that operate in shafts after sinking and equipping of a shaft have been completed.

Permanent winder: The drum winder of a permanent installation.

Sinking installations: This term refers to those winding systems used for shaft sinking.

Kibble winder: The drum winder used for kibble winding during shaft sinking operations. Although this winder is often the permanent winder, the term "kibble winder" is used to distinguish between the operations of a winder and its ropes during shaft sinking operations and their use at a permanent installation.

Out-of-balance: The out-of-balance of a double drum winder is the net result of the rope forces acting on either side of the drum. Normally, the maximum out-of-balance will occur when the one conveyance is at the lowest point in a shaft and fully loaded while the other end of the rope is at its highest position and carries no load. The maximum out-of-balance will be greater when a winder is unclutched.

3. ROPE SAFETY CRITERIA DURING BRAKING

Only rope safety and therefore rope forces are considered in this report. Stopping distances, successive braking, and brake thermal capacity fall outside the scope of this report.

In the proposals for new drum winder rope regulations² a dynamic factor of 2,5 was included to limit the maximum rope forces that can be generated during emergency braking. This limit, which is 40% of the breaking strength of a winding rope, is now part of the winder code of practice.¹

During a tensile test on a rope sample, permanent elongation of a rope generally starts at between 40% and 50% of the new breaking strength of a rope. The limit of 40% was therefore selected so that a winding rope will not be permanently damaged by normal emergency braking.

Winders that do not have to comply with the requirements of the winder code of practice¹ have a minimum safety factor limit of 4,5 (according to the proposed regulations). For these winders, the rope force will not exceed 40% of the breaking strength of the rope as long as the winder deceleration during braking remains less than 4 m/s² (see Appendix B).

Winder brakes normally have more available power than that required to stop the winder at a given retardation rate. If controlled braking results in rope forces close to 40% of the breaking strength of a rope, then uncontrolled braking will result in higher rope forces. For this reason, the winder code of practice¹ includes the requirement that the failure of any one component of the brake system will not result in rope forces greater than 60% of the breaking strength of the rope.

During shaft sinking, men, material and rock are transported in an open kibble slung by chains from the front end of the rope. The only guidance for the kibble is supplied through the crosshead at the end of the rope. Slack at the front end of the kibble winder rope is therefore potentially dangerous, and should be avoided.

4. CRITICAL WINDER DECELERATIONS

A brief description of the computer program used for the calculation of the rope forces is given in Appendix A. Rope mass per unit length and the rope breaking strength were selected according to average values for non-spin ropes given in the Haggie Rand Rope Catalogue, November 1987. The mass and strength of triangular strand ropes (generally used on permanent drum winders) do not differ largely from non-spin ropes. This section will show that it would not have made a significant difference to the results if the properties of triangular strand ropes were used in stead of that of non-spin ropes.

Only the winder rope with a mass attached at the front end was considered for the calculation of the winder decelerations that will generate either slack at the front end of the rope or excessive forces at the back end of the rope.

4.1 BRAKING WHILE ASCENDING

4.1.1 A selected case

Figure 1 shows the behaviour of a winder rope when decelerated at a constant rate of 4 m/s^2 from an ascending winding speed of 16 m/s . An $18\,000 \text{ kg}$ mass was attached at the front end of the rope and the length of suspended rope was $2\,000 \text{ m}$. The rope had a mass of 10 kg/m . For this select case, the rope would have had a strength of around $1\,870 \text{ kN}$, and the capacity and safety factors would have been $10,5$ and $5,0$ respectively. The deceleration of the rope was applied at the back end in the period 1 s to 5 s .

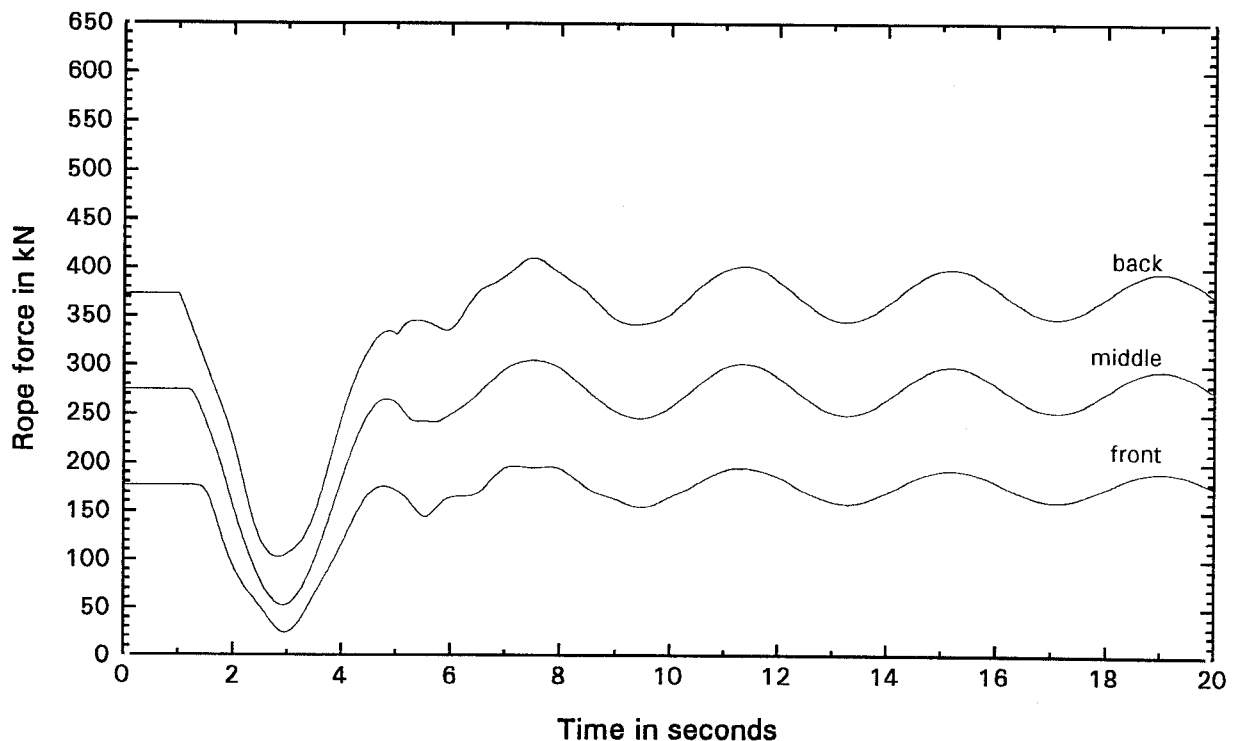

Figure 1: The behaviour of a winder rope when decelerated while ascending.

If the deceleration of the selected case shown in Fig. 1 is increased, a condition will be reached where the front end of the rope becomes slack. In this specific case the front end rope force

reached zero when a constant deceleration of $4,6 \text{ m/s}^2$ was applied.

4.1.2 The general case

A large number of cases were analysed to establish the influence of various attached loads on the deceleration required to produce zero load at the front end of the rope while ascending. A 10 kg/m rope with a strength of $1\,870 \text{ kN}$ was used ($2\,000 \text{ MPa}$ tensile grade). The length of suspended rope was varied from 100 m to $4\,000 \text{ m}$. A capacity factor of 8 represented a fully loaded kibble or a heavy load, while the capacity factors of 32 and 50 represented empty or lightly loaded kibbles. For these analyses, it was assumed that the winder was moving fast enough so that it would only stop after the first trough in the rope force curve had developed fully. The decelerations required to generate zero front end rope load during the first rope force trough after the deceleration occurred are shown in Fig. 2.

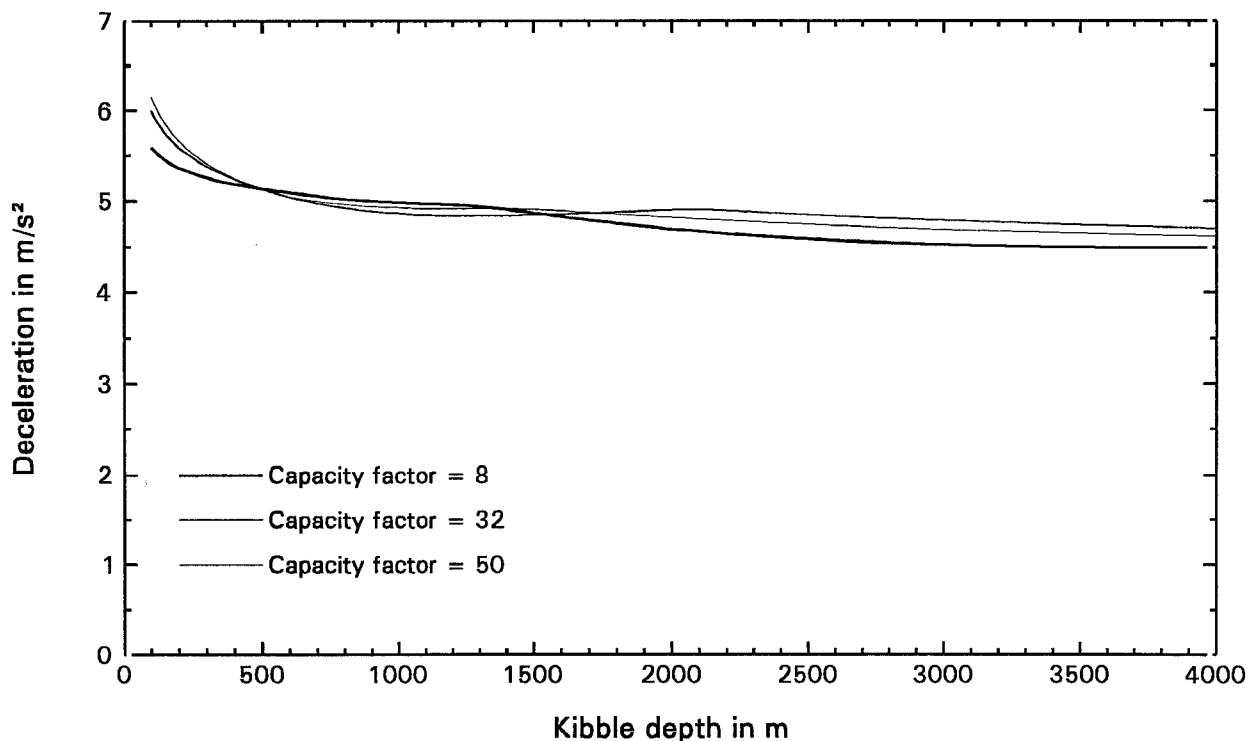

Figure 2: Deceleration required to produce slack at the rope front end while ascending.

Figure 2 shows that a deceleration of at least $4,5 \text{ m/s}^2$ is required to generate zero load at the front end of a rope. Increasing the front end load from $23\,850 \text{ kg}$ (capacity factor of 8) to $30\,000 \text{ kg}$ (capacity factor of 6,3) will only reduce the required deceleration by $0,02 \text{ m/s}^2$. It is unlikely that any $4\,000 \text{ m}$ winder will have a capacity factor of less than 8. A $4,5 \text{ m/s}^2$ limit to the retardation rate of any drum winder configuration will therefore prevent the generation of slack rope during the first rope force trough after the deceleration occurred.

It is of interest to note that the capacity factor 50 curve is lower than the capacity factor 32 curve at depths greater than $1\,500 \text{ m}$. Reducing the front end load from a capacity factor of 8 initially increases the deceleration required to obtain slack rope, but from a capacity factor of around 32, the required deceleration reduces again. The rope behaviour was checked with front end loads of as low as 200 kg , but slack was not generated at decelerations of $4,5 \text{ m/s}^2$.

The attached front end load does not have a very significant influence on the deceleration required to produce zero load in a rope. The reason is the following: The kibble rope load range report³ showed that the maximum (or minimum) rope force at the front end of the rope, generated by a constant acceleration (or deceleration), can be written as:

$$Force = mass [g + a(1 + \alpha)] \quad (1)$$

with: $mass$ = attached mass
 g = gravitational acceleration
 a = value of a constant acceleration at the drum end
 α = dynamic (amplification) factor

The dynamic factor for the front end of the rope was found to be less than 1,15 except for very deep winds with very heavy loads, which have slightly larger dynamic factors. For zero force at the front end of the rope, Eqn. 1 can be rewritten as:

$$a = \frac{-g}{1 + \alpha} \quad (2)$$

Equation 2 does not contain any mass elements, with the only variable being the dynamic factor, which is independent of the winder acceleration. The dynamic factor does not vary much for different winder combinations and this is reflected by constant nature and the closeness of the curves in Fig. 2. A dynamic factor of 1,15 gives a deceleration of 4,56 m/s², and a deceleration of 4,5 m/s² (for the deep winds with heavy loads) requires $\alpha = 1,18$.

4.1.3 The effect of winder speed

Figure 3 shows the rope behaviour of a winder with a 10 kg/m rope with an attached mass of 23 850 kg at a depth of 4 000 m, decelerated at 4,5 m/s² while ascending at a constant speed of 13,7 m/s. The deceleration was applied after 1 second. Just more than 3 seconds was required to bring the winder drum to a halt. On the graph this is then just after 4 seconds. The rope strength is 1 870 kN for a 2 000 MPa rope.

The first dynamic event is the application of the constant deceleration. If the winder drum stops, the deceleration drops to zero, which is another dynamic event. Timing this second event so that it occurs when the minimum rope forces are present, maximizes the rope dynamics that follow. This can lead to slack rope during the second rope force trough as shown in Fig. 3. The maximum rope force was 57% of the breaking strength of the rope.

The rope force behaviour shown in Fig. 3 is not a general pattern. It can only happen for specific timing of the events, i.e. the deceleration and the initial winder speed have to be matched to bring the winder drum to a halt at a given moment. The required duration of the deceleration to maximize the rope dynamics that follow after the winder was brought to a halt, was found to one half of the first natural period of oscillation of the rope-mass system. Deviating by plus and minus 5% from this duration produces the same results. The occurrence and timing of the above were analysed for a number of cases. It was found that, for any timing of events, slack during the second rope force trough cannot occur at depths less than 3 000 m, if slack did not occur during the first rope force trough. For depths greater than 3 000 m, slack rope will not occur for any timing of the events if the deceleration is less than 4,35 m/s².

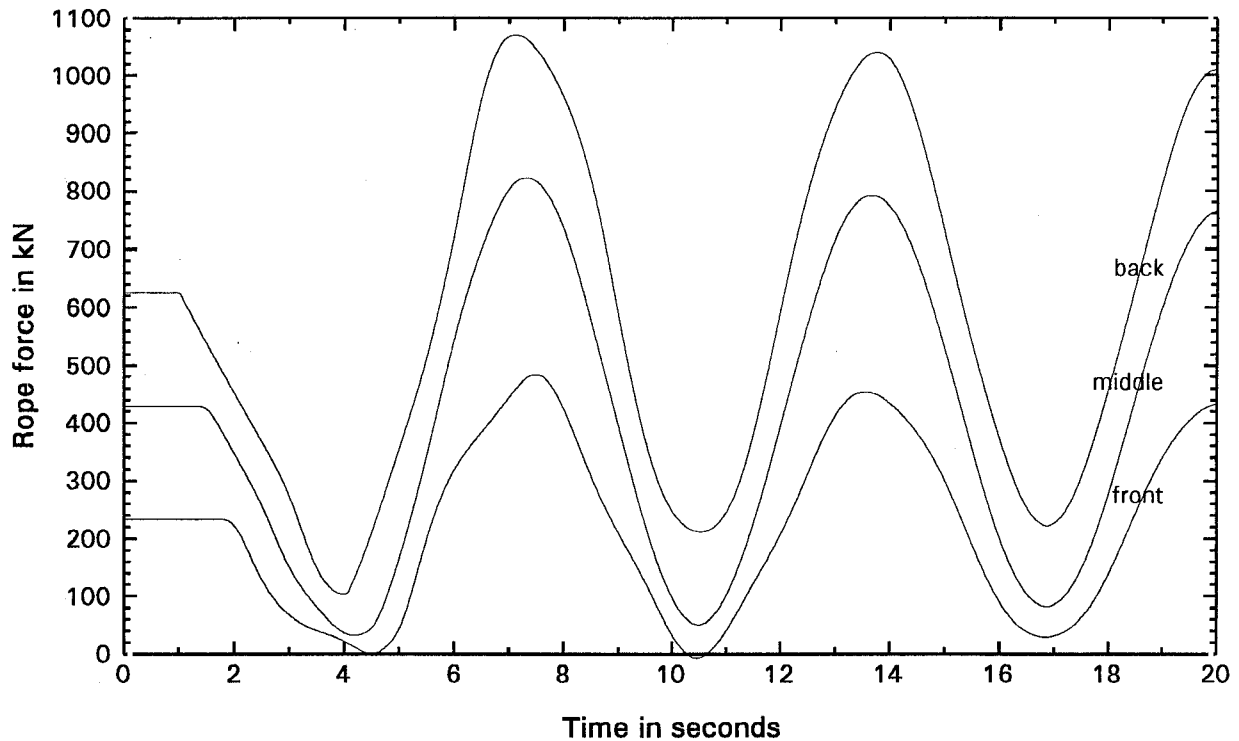

Figure 3: The behaviour of a winder rope with a 23 830 kg attached mass at 4 000 m decelerated at $4,5 \text{ m/s}^2$ while ascending at $13,7 \text{ m/s}$.

If the winder deceleration is greater than $4,5 \text{ m/s}^2$ and the static rope safety factor is on the lower side, the positive rope forces that are generated after slack rope occurred could be greater than 60% of the breaking strength of the rope.

4.1.4 The effect of winder acceleration before braking

The analyses described in the preceding sections were based on the assumption that no rope force oscillations or any forces other than the static rope forces were present at the start of the braking deceleration. If braking takes place during winder acceleration or shortly after full winding speed was reached, rope forces from the acceleration of the winder and/or rope force oscillations could still be present.

Figure 4 shows a winder that is accelerated smoothly at 1 m/s^2 . Emergency braking takes place while the winder is still being accelerated. The winder and rope parameters and the deceleration rate of 4 m/s^2 is the same as those of Fig. 1. The winder speed was $11,1 \text{ m/s}$ and the conveyance was at 2 000 m when braking took place. In this case, zero front end load would occur with a deceleration of $4,1 \text{ m/s}^2$ as opposed to $4,6 \text{ m/s}^2$ for the case shown in Fig. 1.

Figure 5 shows what can happen if the acceleration of the winder generates rope force oscillations. In this case the winder was decelerated from $9,6 \text{ m/s}$ at 4 m/s^2 . The front end of the rope became slack in this case. Zero front end load would occur with a deceleration of $3,75 \text{ m/s}^2$.

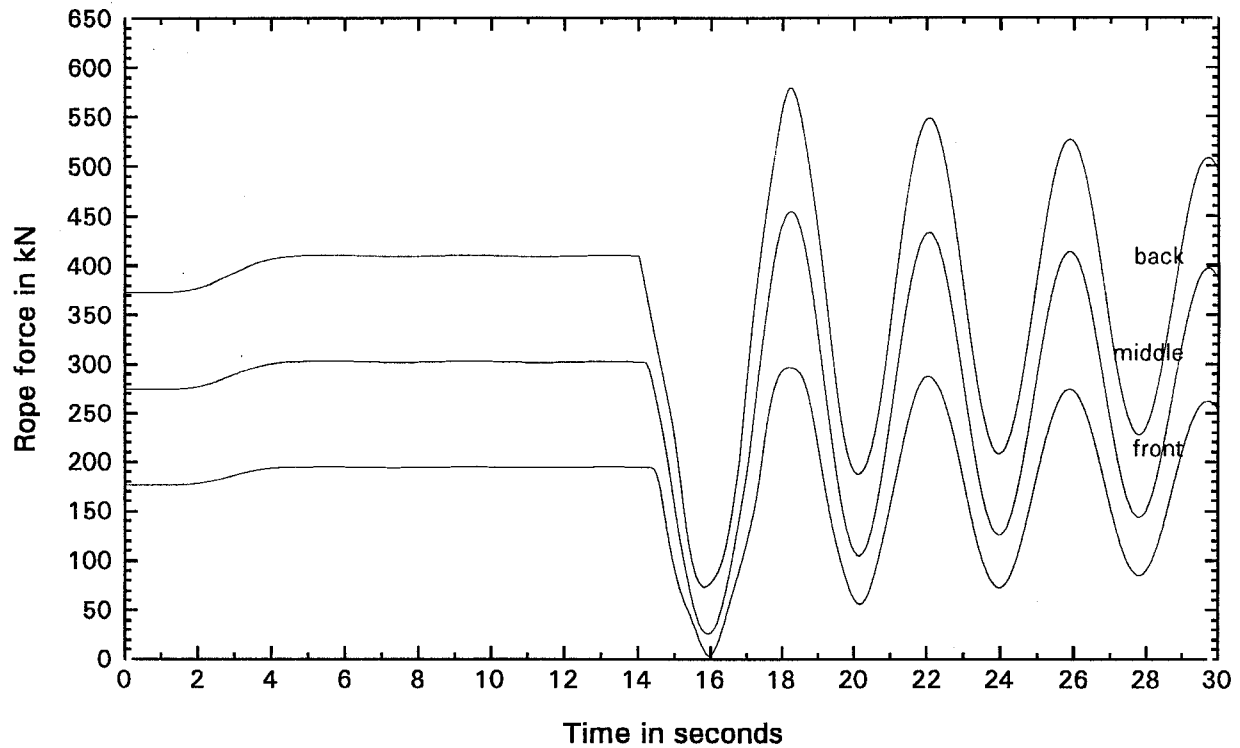

Figure 4: Braking during the acceleration period of a winder: 18 000 kg attached mass at 2 000 m decelerated at 4 m/s^2 while ascending at $11,1 \text{ m/s}$.

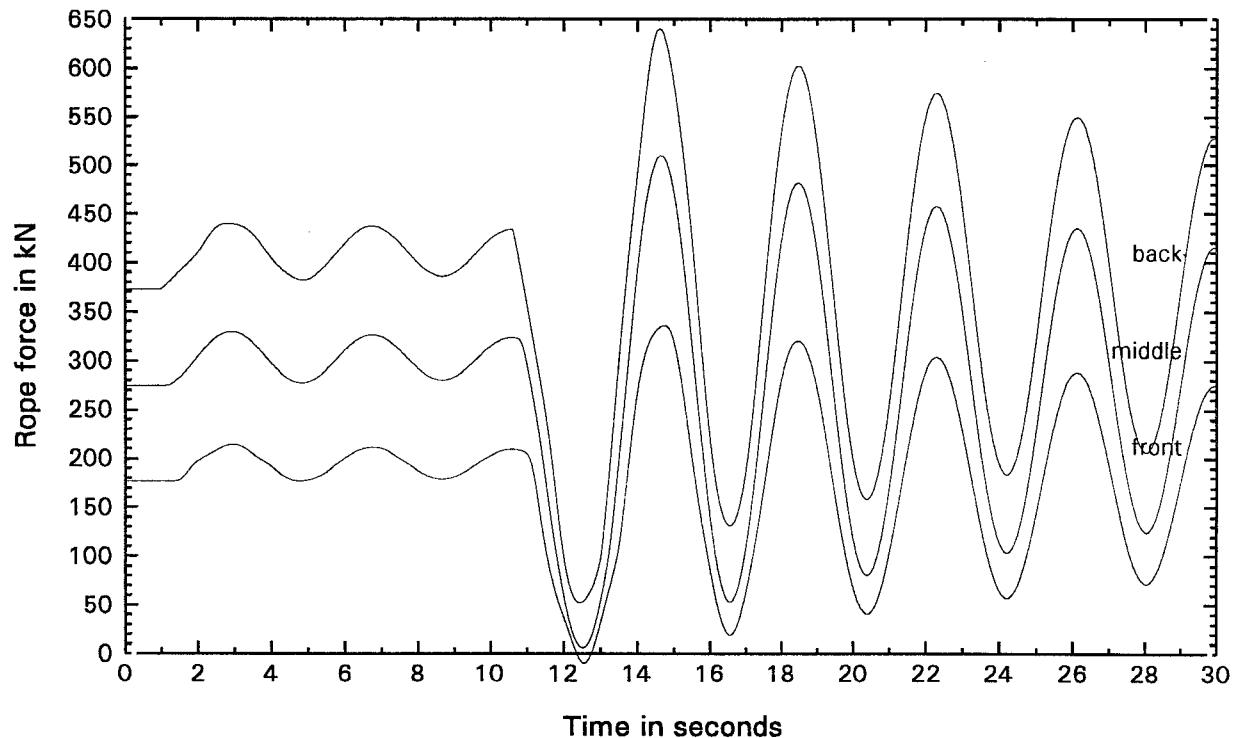

Figure 5: Braking during the acceleration period of a winder: 18 000 kg attached mass at 2 000 m decelerated at 4 m/s^2 while ascending at $9,6 \text{ m/s}$.

Winder trip-outs while accelerating is not uncommon. During acceleration, high winder motor currents are drawn which could lead to an over-current trip-out. Slack at the front end of the rope

could occur with winder decelerations of as low as $3,6 \text{ m/s}^2$ for lower safety factor winders if the "right" rope dynamics are present at the start of the braking deceleration. This is considerably lower than the $4,5 \text{ m/s}^2$ shown in Fig. 2 for the case where the winder travels at a constant speed with no rope force oscillations present at the start of braking deceleration. This also means that deep low safety factor winders could generate rope forces in excess of 60% of rope breaking strength at decelerations (while ascending) lower than the $4,5 \text{ m/s}^2$ (but not before slack rope occurred).

4.2 BRAKING WHILE DESCENDING

4.2.1 Maximum rope force

Figure 6 shows the behaviour of a winder rope when decelerated at a constant rate of 4 m/s^2 from an descending winding speed of 16 m/s . As for the ascending case (Fig. 1, p. 4), an $18\,000 \text{ kg}$ mass was attached at the front end of the rope and the length of suspended rope was $2\,000 \text{ m}$. The rope had a mass of 10 kg/m and a strength of $1\,870 \text{ kN}$. The deceleration of the rope was applied at the back end in the period 1 s to 5 s to bring the winder drum to a standstill. For the general case it was assumed that the only rope forces present, at the start of the deceleration while the winder descended at a constant speed, were the static rope forces.

The maximum rope force (at the back end of the rope) is directly proportional to the total mass of the system (and therefore inversely proportional to the safety factor) and the value of the deceleration. The maximum rope force during braking while descending is calculated in Appendix B. It is shown that as long as the winder deceleration during emergency braking is not greater than $4,5 \text{ m/s}^2$, the maximum rope force for any realistic drum winder configuration will be less than 60% of the breaking strength of the winder rope. This is, of course, assuming that the only rope forces present at the start of the deceleration is the static rope forces.

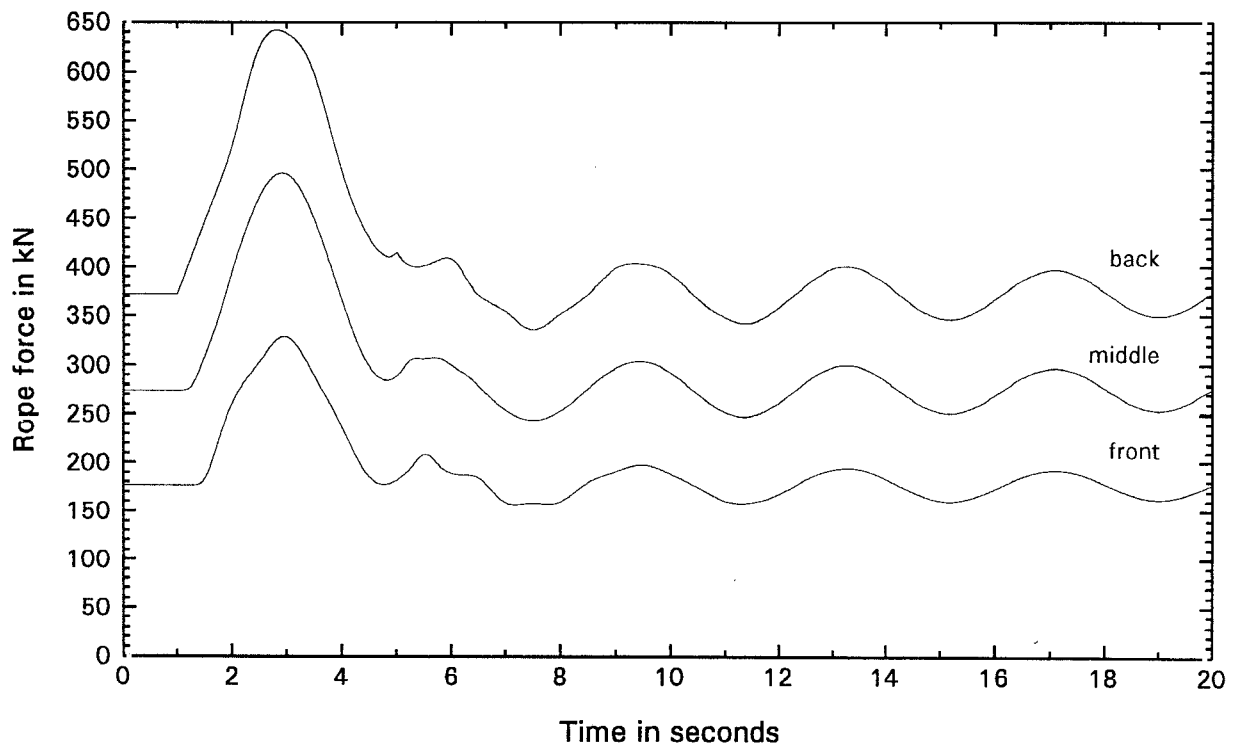

Figure 6: The behaviour of a winder rope when decelerated while descending.

4.2.2 Slack rope during descending

In the analysis of the rope forces for an ascending winder in section 4.1.3, it was shown that the timing of events has an influence on the rope behaviour. In this section the possibility of generating slack at the front end of the rope after decelerating a descending winder is investigated.

The lowest rope forces are generated when the winder comes to a standstill exactly at the time that the rope forces during deceleration are at their peak values. As before, the peaks occur approximately after the deceleration was applied for one half of the first natural period of the rope-attached-mass combination.

Figure 7 shows this behaviour for the winder system of Fig. 6. Here the winder was again decelerated at 4 m/s^2 , but only from a constant winder speed of $7,36 \text{ m/s}$.

If the winder speed and deceleration of the case shown in Fig. 7 are increased, a situation could be created that will lead to slack rope at the rope front end during the first trough of the rope forces.

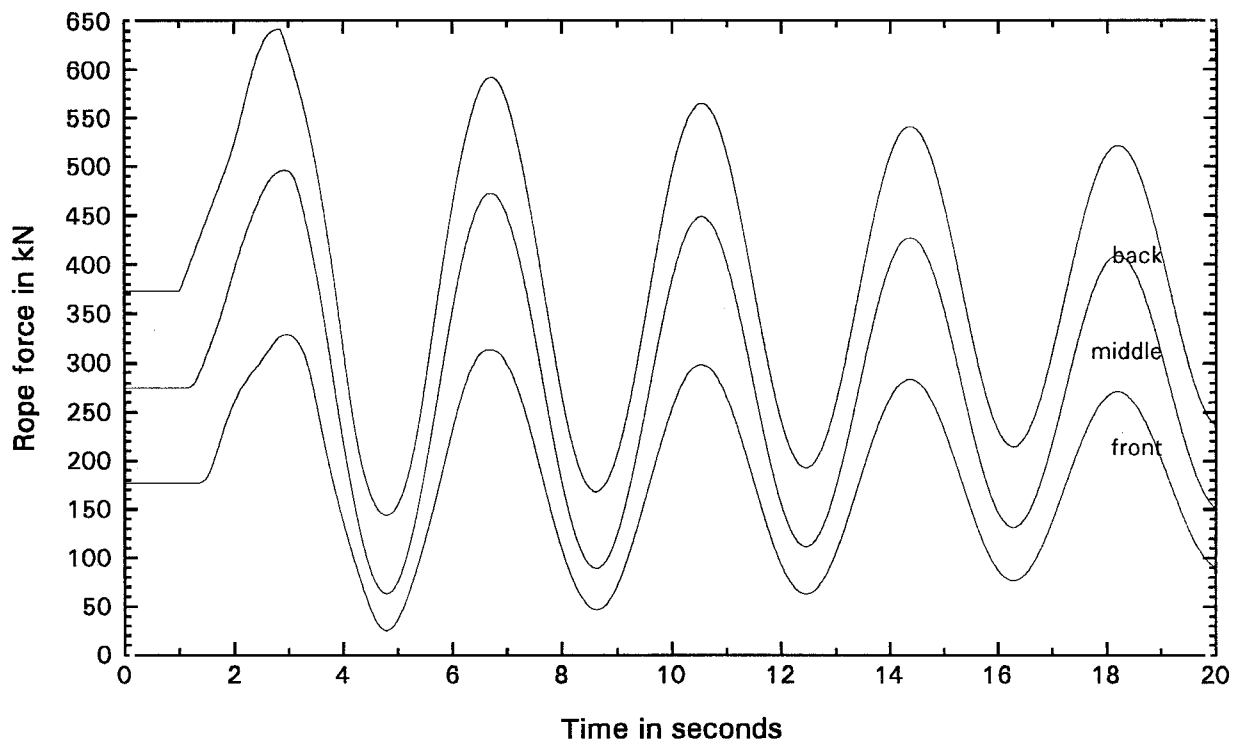

Figure 7: Decelerating a winder at 4 m/s^2 from a descending speed of $7,36 \text{ m/s}$. The winder came to a standstill at the point where the rope forces peaked.

A large number of cases was analysed to establish the influence of various attached loads on the deceleration required to produce zero load at the front end of the rope after braking from a constant speed during descending. A 10 kg/m rope with a strength of $1\,870 \text{ kN}$ was used ($2\,000 \text{ MPa}$ tensile grade). The length of suspended rope was varied from 100 m to $4\,000 \text{ m}$. The front end loads were varied from $2\,000 \text{ kg}$ to approximately $24\,000 \text{ kg}$. A capacity factor of 8 represented a fully loaded kibble or a heavy load, while the capacity factors of 32 and 50 represented empty or lightly loaded kibbles, and a capacity factor of 100 represented a very light load. For these analyses, it was assumed that the winder was moving fast enough so that it would

only stop after the first peak in the rope force curve was fully developed. The decelerations required to generate zero front end rope load during the first rope force trough are shown in Fig. 8.

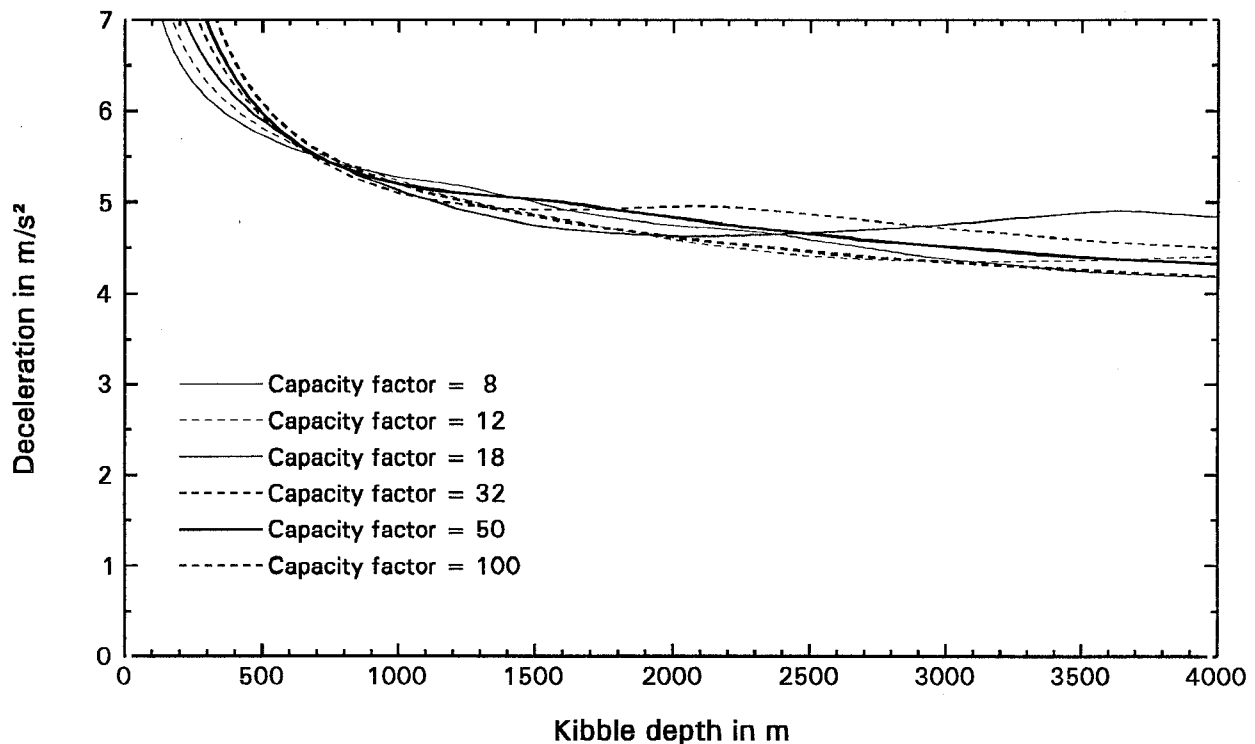

Figure 8: Drum deceleration required while descending to produce slack at the rope front end. The winder speed and deceleration was matched to produce minimum rope forces.

According to Fig. 8, the generation of slack rope while descending and braking is not greatly dependent on the mass attached at the rope front end, and does not vary much with depth. If the deceleration is less than 4.1 m/s^2 , it is not possible to generate slack rope at the rope front end for the situation when a winder is decelerated while moving at a constant speed.

4.2.3 The effect of normal winder deceleration before braking

In the preceding section the rope forces generated when braking a winder moving at a constant speed were analysed. It is also possible that emergency braking could take place while the winder is in the process of decelerating at the end of the wind after descending.

Figure 9 shows the rope behaviour for a winder of which the normal deceleration does not produce rope force oscillations. As before, a 10 kg/m rope with an attached mass of $18\,000 \text{ kg}$ was used. The winder travelled at 16 m/s before it started decelerating at 1 m/s^2 . The brakes were activated when the conveyance was at a depth of $2\,000 \text{ m}$. A deceleration of 4 m/s^2 was applied, and the timing of events was such that the lowest rope forces were produced. For this case the rope forces were not as low as for when the winder was braked while moving at a constant speed (see Fig. 7).

The normal deceleration of the winder could also be such that rope force oscillations are present before the brakes are applied. This is shown in Fig. 10. The rest of the winder parameters are as before, and the timing of the events was again selected to produce the lowest rope forces. The

rope forces were again not as low as for when the winder was braked while moving at a constant speed.

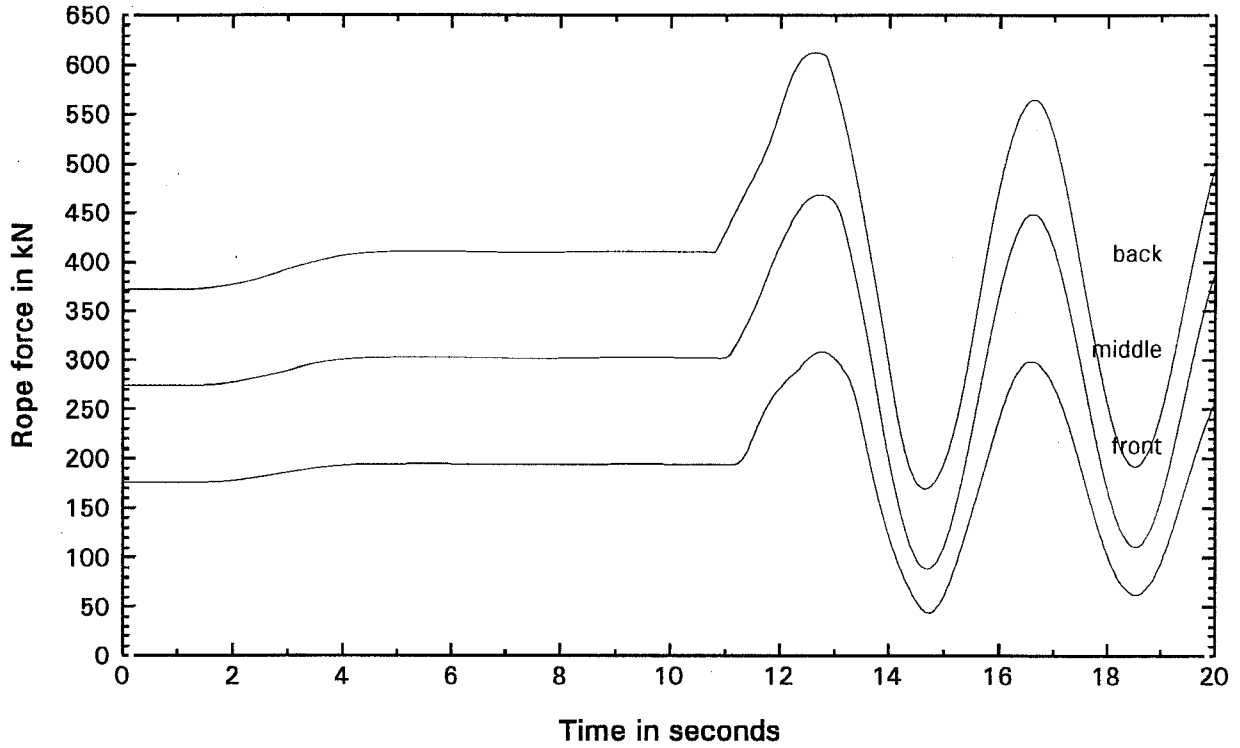

Figure 9: Braking a winder during normal deceleration while descending. Braking deceleration of 4 m/s^2 applied. Events were timed to produce the lowest rope forces possible.

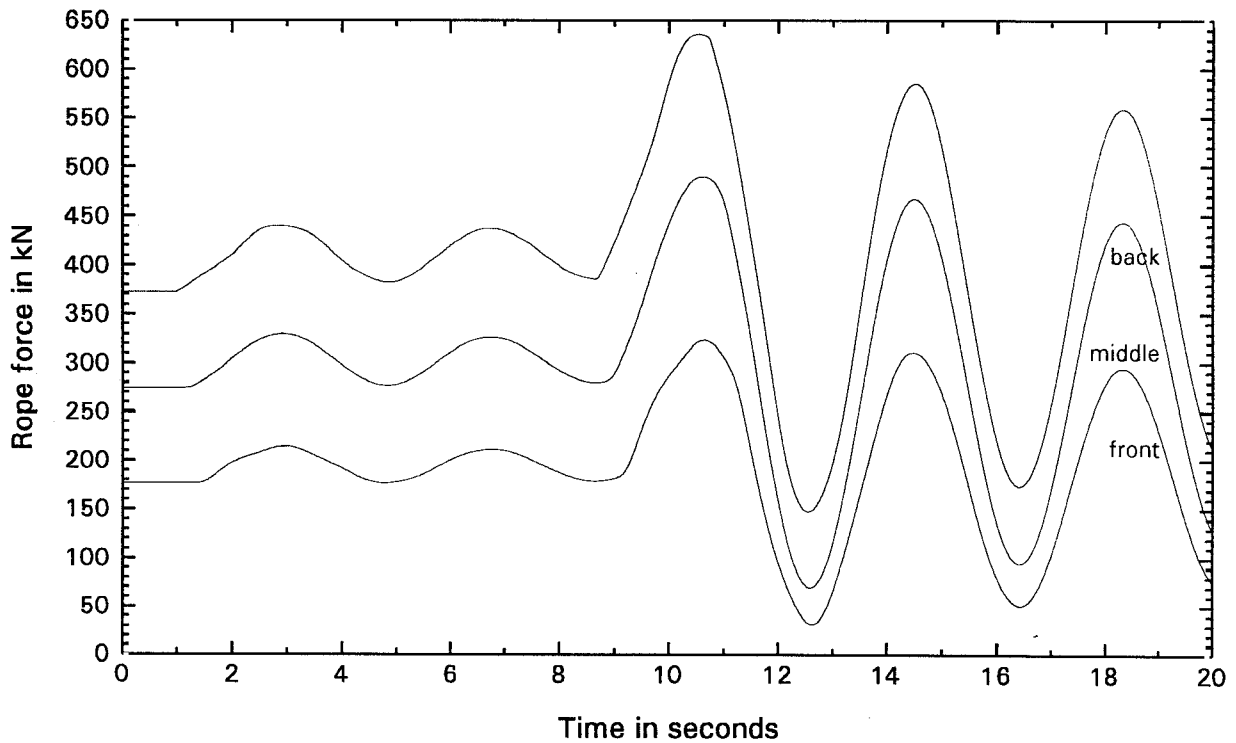

Figure 10: Braking a winder during normal deceleration while descending. Braking deceleration of 4 m/s^2 applied. Events were timed to produce the lowest rope forces possible.

4.2.4 The effect of normal winder acceleration before braking

Figure 8, p. 11, showed that relatively high decelerations are required to generate slack rope with short ropes. Slack at the front end of the descending rope will therefore not develop if braking takes place while the winder is accelerated at the beginning of the descending trip.

It is possible that a winder can be accelerated to descend further if the descending winding trip was interrupted. Emergency braking could therefore take place at depth while the winder is in the process of being accelerated while descending. The same winder parameters (10 kg/m, 18 000 kg attached) were selected to illustrate the rope force behaviour in such a case. The only difference being that the winder is accelerated from standstill.

Figure 11 shows the rope behaviour for a winder of which the normal acceleration does not produce rope force oscillations. The normal acceleration was 1 m/s^2 . When the appropriate speed was reached to produce the lowest rope forces at a deceleration of 4 m/s^2 , the brakes were applied. At that time the conveyance was at a depth of 2 000 m. In this case the front end rope force reached a lower value than when the winder was braked while moving at a constant speed (see Fig. 7), but not quite as low as for the comparable case when the winder was ascending (see Fig. 4).

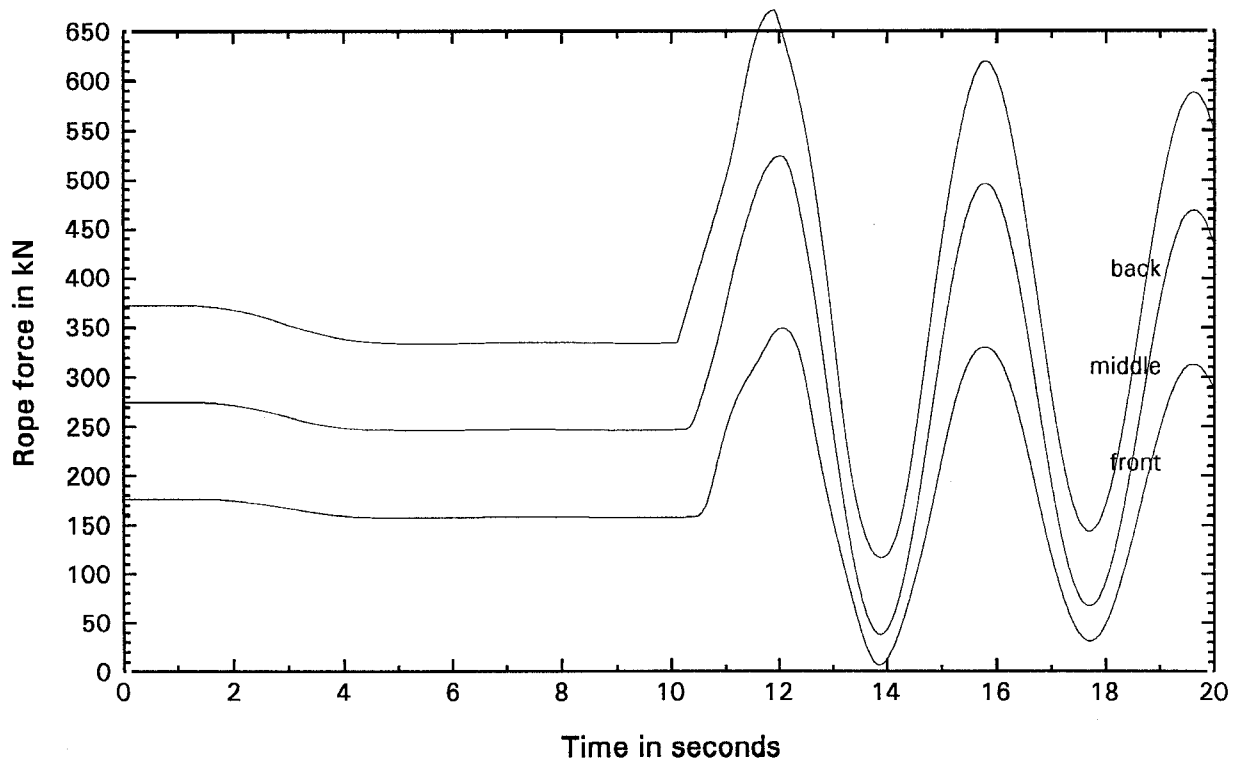

Figure 11: Braking a winder being normally accelerated at depth while descending. Braking deceleration of 4 m/s^2 applied. Events were timed to produce the lowest rope forces possible.

As before, the normal acceleration of the winder could also be such that rope force oscillations are present before the brakes are applied. This is shown in Fig. 12. The rest of the winder parameters are as before, and the timing of the events was again selected to produce the lowest rope forces. The rope forces were again lower as for when the winder was braked while moving at a constant speed, but not as low as for the comparable case when the winder was ascending (see Fig. 5, in which slack was produced).

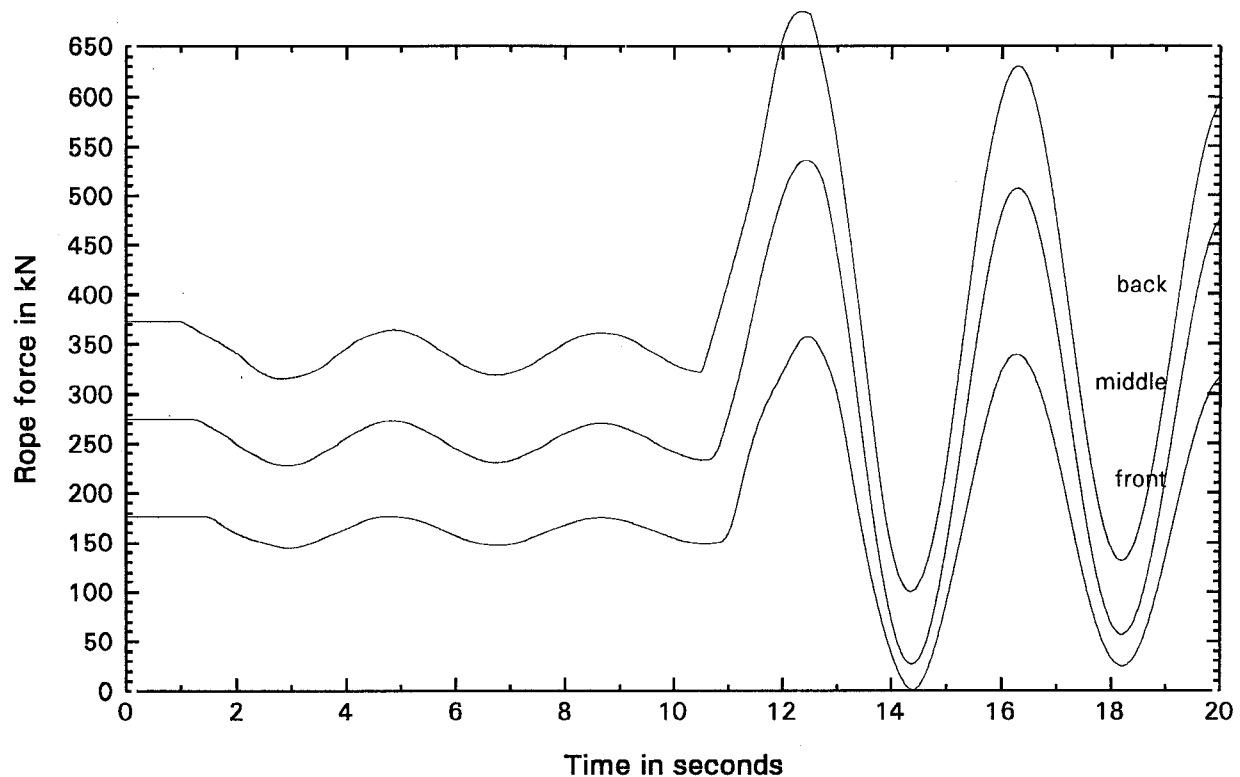

Figure 12: Braking a winder being normally accelerated at depth while descending. Braking deceleration of 4 m/s^2 applied. Events were timed to produce the lowest rope forces possible.

4.3 SUMMARY OF CRITICAL BRAKING DECELERATIONS

Under the same circumstances, slack at the rope front end can be generated at lower decelerations on the ascending side of a winder than on the descending side. If a conveyance and rope is ascending at a constant speed, slack rope can be generated at decelerations of 5 m/s^2 at 500 m depth, $4,8 \text{ m/s}^2$ at 1 000 m and $4,5 \text{ m/s}^2$ from 3 000 m to 4 000 m.

When an ascending conveyance is accelerated from shaft bottom, matching the winding speed and deceleration can generate slack rope at rates of as low as $3,6 \text{ m/s}^2$ for long suspended ropes. Under these circumstances shorter suspended ropes will require around 4 m/s^2 .

As long as the winder deceleration during emergency braking is not greater than $4,5 \text{ m/s}^2$, the maximum rope force for any realistic drum winder configuration will be less than 60% of the breaking strength of the winder rope on the descending side. At this deceleration, a winder with a safety factor of 3,125 will get close to 60%.

Although the analysis of the maximum rope forces generated after slack rope occurred at an ascending conveyance was not carried out in detail, matching of the speed and the deceleration generated maximum rope forces close to that calculated for a descending conveyance at the same depth and deceleration.

5. WINDER DECELERATION AFTER BRAKE CONTROL FAILURE

5.1 WINDER BRAKES AND BRAKE CONTROL

The layout and design of drum winder brakes and their control systems, together with a brief analysis of effects of brake control failure, are given in Appendix C. It is shown that the brakes of a drum winder are normally designed to have a braking torque capacity equal to some multiple of the maximum unclutched out-of-balance torque of the winder, for example:

A double drum winder with one brake per drum will normally have a brake design torque capacity of two times maximum unclutched out-of-balance plus 10% for each of the two brakes; i.e. 2,2 times out-of-balance per brake. During emergency braking, such a winder will be able to stop normally on one of the brakes only. The actual friction coefficient of the brake lining material is usually greater than the design value, which further increases the capacity of the brakes. It is shown that each brake of a double drum winder could have a capacity of 2,5 times the maximum unclutched out-of-balance torque.

In the rest of this report, the maximum unclutched out-of-balance torque of a winder will be referred to as the "Brake OoB torque", and the rope force value that produces this torque will be referred to as "Brake OoB".

In Appendix C it is further shown that the brake efforts that can be applied after brake control failure are as follows in terms of "Brake OoB":

- 2,5 times for a double drum with two brakes and two (independent) control systems.
- 2,5 times for a BMR or double drum with four brakes and two control systems.
- 1,67 times for a double drum with three brakes and three control systems.
- 1,25 times for a BMR or double drum with four brakes and four control systems.

For the above, it was assumed that the total design braking capacity of each of the above winder configurations was 4,4 times "Brake OoB". The actual (maximum) total brake capacity would then be 5 times "Brake OoB".

5.2 WINDER PARAMETERS

Eighteen different double drum winder configurations were investigated to determine the brake effort required to produce the critical winder decelerations of the preceding section. The winders were designated "No. 1" to "No. 18" and are listed in Tables 1 and 2 (pages 24 to 27). These winders cover a wide range of possible winder configurations. The winder parameters, listed in the top halves of the tables, were selected and calculated as follows:

The winders were designed for permanent hoisting duties. It was assumed that all the winders could be used as kibble winders. All the winder motors were directly coupled to the drum shafts.

A rope diameter and shaft depth was selected for each winder. A rope tensile grade of 2 000 MPa was used for all the ropes. Rope mass per unit length and the rope breaking strength were selected according to average values for non-spin ropes given in the Haggie Rand Rope Catalogue.

A realistic safety factor was selected for each winder. The total (maximum) attached mass could

then be calculated. The conveyance mass was selected as 30% of the attached mass. The payload mass was therefore 70% of the attached mass.

The drum diameters were calculated using a drum diameter to rope diameter (D/d) ratio of 100, although this value was increased for some of the winders. Small drums have lower moments of inertias than larger drums. For the same brake effort, the deceleration of smaller drums will be greater than that of larger drums. Most drum winders have D/d -ratios of 100 and greater. The D/d -ratio of 100 was selected to give relatively small drum diameters.

The drum width was selected as one third of the drum diameter with a minimum value of 1,3 m. Fifteen dead rope coils were added in each case. 2 mm was added to the rope diameter to determine the number of turns per rope layer on the drum. If more than 4,5 layers of rope on the drum was required, the drum width was increased. On some of the deep shafts, the number of rope layers had to be increased to 5 to prevent the drums becoming unrealistically wide. It was assumed that all coiling took place at drum diameter. The increase in coiling diameter from one rope layer to the next was ignored.

The moment of inertia of a winder drum was calculated according to the information in Appendix D. Kimberley Engineering Works gave the inertia of a headgear sheave as $100 d^{3,25}$ with the sheave diameter, d , in metres and the inertia in $\text{kg}\cdot\text{m}^2$. It was assumed that the sheave diameters were the same as the drum diameters.

The "Brake OoB" refers to the maximum unclutched out-of-balance weight, i.e. the sum of the weights of one rope, one conveyance and one payload. Multiplying this value with the drum radius gave "Brake OoB torque". The "Normal OoB" is the maximum out-of-balance weight under permanent winding circumstances, i.e. the weight of one rope plus a full payload.

The "Normal OoB" torque was used to calculate the inertia of the winder motor according to the information in Appendix E.

All rotating masses were "linearised" by dividing the inertia by the square of the drum radius. These are presented as "kg"-values for the drum, motor and headsheave.

The listed "Total mass" of a winder is the sum of the masses of the drum, a motor, two sheaves, two ropes, two conveyances, and one payload. Some values were calculated for the sake of interest: The "Rotating" mass is the sum of the masses of the drum, the motor, and one rope. One length (shaft depth) of rope is always present on the drum. The rotating parts make up 73% to 85% of the "Total mass". The percentages for a payload and one rope are also given.

5.3 BRAKING

The rotating part of the total winder "mass" is so much greater than the suspended masses, that the rope dynamics during deceleration of a winder will only have a small effect on the dynamics of the drum. Average deceleration of the complete system will however not be affected.

The values listed in the bottom halves of Tables 1 and 2 are the brake efforts required to produce given (constant) winder decelerations under different winding and loaded conditions. The winder deceleration of $2,25 \text{ m/s}^2$ was selected as the normal deceleration of the winder during emergency braking. The winder decelerations of $3,6 \text{ m/s}^2$, 4 m/s^2 and $4,5 \text{ m/s}^2$ are some of the critical winder decelerations according to section 4.3, p. 14. The different winding and loaded conditions and the "Revised Brake OoB" values are explained below.

The "Normal, down full" condition is for the permanent winder configuration, descending with a full load at shaft depth and an empty conveyance on the other rope. For this condition, the "Total mass" of the system is as listed in the table. The force required to decelerate a winder was obtained by multiplying the total mass with the (linear) winder deceleration. In this case of a full load descending, the brakes must also provide for the out-of-balance force. Dividing this total braking force by the "Brake OoB" value gives the required brake effort as a multiple or fraction of the "Brake OoB" value. For example: At $2,25 \text{ m/s}^2$, winder "No. 2" requires 2,16 times "Brake OoB". For this situation, this winder will therefore (just) be able to stop normally on one brake during emergency braking. In this case, approximately 60% of the brake effort was required to decelerate the mass of the system, while the remaining 40% was required to counter the out-of-balance.

Some of the eighteen winder configurations required more than 2,2 times "Brake OoB" for "Normal, down full". Winder "No. 1" is such an example. The brake capacity of these winders were increased to the "Revised Brake OoB" values so that only 2,2 times "Revised Brake OoB" would be required to stop a full load going down at $2,25 \text{ m/s}^2$.

When geared motors are used (normally the case for small drum winders), the inertia of the winder motor referred to the winder drum speed approaches the inertia value of the drum itself. Such configurations will require even more braking effort than that shown by the calculations for motors coupled directly to the drums.

The "Normal, full and balanced" values reflect the braking effort when one conveyance is fully loaded, but with the two sides of the winder in a balanced position. "Normal, down full" was discussed above. "Normal, up full" refers to a fully loaded conveyance at shaft depth and ascending, and an empty conveyance descending. Here the out-of-balance load assisted the brakes, and less braking effort was required.

The rest of the values in the tables are for when the winders are used for kibble winding duties. It was assumed that the maximum attached mass for kibble duties were the same as for the permanent hoisting duty. A empty kibble mass of 20% of the attached mass was assumed.

Full loads descending at final shaft depth during kibble winding will require approximately the same braking efforts as full loads descending during normal winding (see "Normal, down full").

During shaft sinking the shaft depth progressively increases form zero to the maximum shaft depth. "Light kibble, short rope" represents a very short starting rope and no out-of-balance loads. "Light kibble, full rope, up" represents the situation at final shaft depth with a lightly loaded or empty kibble at shaft depth ascending and only the crosshead on the descending rope. "Full kibble, full rope, up" represents the situation at final shaft depth with a fully loaded kibble at shaft depth ascending and only the crosshead on the descending rope.

The brake efforts required to give a certain winder deceleration for a given situation have all been expressed in terms of the "Brake OoB" or the "Revised Brake OoB" values. From here and onwards, "Revised Brake OoB" will simply be referred to as "Brake OoB". If brake control failure could lead to, for example, the application of a brake effort of 2,5 times the "Brake OoB" value, then all the situations with listed values of less than 2,5 are possible. If the brake configuration on a winder is such that only one times "Brake OoB" could be applied after brake control failure, then only the situations with listed values less than one would be possible.

A specific example: Winder "No. 13", Table 2: For a full kibble ascending from final shaft

depth, a brake effort of only 0,05 times "Brake OoB" is required to stop the winder at 2,25 m/s². This means that the natural retardation of the winder in that situation is nearly enough to stop the winder at the required rate. To decelerate the winder in the same condition at 4,5 m/s² requires a brake effort of 1,09 times "Brake OoB".

The double drum winders in Tables 1 and 2 also represent half BMR winders.

5.4 DISCUSSION OF THE REQUIRED BRAKE EFFORTS

The brake efforts that can be applied during brake control failure were discussed in section 5.1 above. The winder decelerations required to generate excessive rope forces at the back end of the rope and slack at the front end of the rope were summarised in section 4.3, p. 14.

The worst brake control failure case will give 2,5 times "Brake OoB". Inspection of the "Normal, down full" values in Tables 1 and 2 shows that all eighteen winders will decelerate at less than 3,6 m/s² during such a brake application. If the ascending conveyance is loaded as well, the out-of-balance will be less but the total system mass will be greater, and the situation would be much the same. It was shown that for a conveyance descending near shaft bottom, a rope safety factor of as low as 3,125 and a winder deceleration as high as 4,5 m/s² are required to generate rope forces near 60% of the breaking strength of the rope. Brake control failure will therefore never lead to rope forces in excess of 60% of the breaking strength of a winding rope on the descending conveyance side.

For "Light kibble, short rope", nearly all the braking effort goes into retarding the rotating masses. This condition also represents a very large winder performing a very light hoisting duty. Brake control failure which results in 2,5 times "Brake OoB" will give winder decelerations of more than 4,5 m/s² in all cases, and could generate slack rope on some of the winders configurations if the kibble is ascending. The rest of this section will consider ascending conveyances.

The differences between "Normal, up full", "Light kibble, full rope, up" and "Full kibble, full rope, up" are not that great, especially for the higher winder decelerations. This is so because most of the brake effort goes into decelerating the rotating parts of a winder. Payload only makes up a small part of the total system mass, but contributes more to the out-of-balance of a winder.

The winder decelerations required to give slack at the front end of the rope for a conveyance and rope ascending at a constant speed are 5 m/s² at 500 m depth, 4,8 m/s² at 1 000 m and 4,5 m/s² from 3 000 m to 4 000 m (see section 4.3, p. 14). It was also shown that when an ascending conveyance is accelerated from shaft bottom, matching the winding speed and deceleration can generate slack rope at rates of as low as 3,6 m/s² for long suspended ropes. Under these circumstances shorter suspended ropes will require around 4 m/s².

Most of the winders of Tables 1 and 2 require less than 2 times "Brake OoB" to decelerate at 4,5 m/s² for the "Normal, up full" and "Full kibble, full rope, up" conditions, as well as for the "Light kibble, full rope, up" condition. For brake control failures that result in 2,5 times "Brake OoB", slack rope on the ascending conveyance side of a drum winder is therefore very possible on any of the winder configurations.

Winder decelerations of as high as 4 m/s² are still possible on some of the winders even if brake control failure results in the application of only 1,25 times "Brake OoB".

When the out-of-balance of a winder assists braking, the occurrence of slack rope after brake control failure cannot be prevented on a double drum winder with two brakes only. With three and four separate brake systems, designed according to current criteria, the occurrence of slack rope after brake control failure cannot be prevented under all circumstances.

In Fig. 3, p. 7, it was shown that high rope forces could be generated on the rebound after slack rope occurred at the front end of the rope. Winder "No. 14" was designed for 4 000 m and a safety factor of 3,125. This winder requires a value of only 1,26 times "Brake OoB" under permanent winding conditions to give a deceleration of 4,5 m/s² when a fully loaded conveyance is ascending from shaft bottom. A full kibble ascending from shaft bottom (final depth) requires 1,10 times "Brake OoB" for a winder deceleration of 4,5 m/s². If 2,5 times "Brake OoB" is applied when a full kibble is ascending from shaft bottom, the winder will decelerate at around 7 m/s². This will generate a severe slack rope condition. The model with which the rope forces were calculated only provided for slack rope by letting the rope go into compression. However, the indications are that for winding speeds greater than 13 m/s when brake control failure occurs, the maximum rope forces on the rebound will be greater than 60% of the breaking strength of the rope.

Slack rope on future winders can be prevented by employing a brake design strategy as explained in section C5, p. 38, and then only if four separate brake systems are present. Brake control failure will then result in the application of only 0,83 times "Brake OoB". The regulations governing winder brakes will have to be revised before such systems can be employed.

Apart from disregarding brake control failure, there does not seem to be an obvious solution to prevent the occurrence of slack rope after brake control failure on current drum winder designs.

This analysis of the effects of brake control failure shows, quite ironically, that the "safest" situation for brake control failure to occur is while descending with a full load near the bottom of the shaft.

5.5 CASE STUDIES

Four permanent drum winder installations that were used for kibble winding duties are analysed in this section. They are: Vaal Reefs 11 Shaft "man" winder, Vaal Reefs 11 Shaft "rock" winder, West Driefontein 9 Shaft man/material/rock winder, and Western Areas South Deep man winder, a BMR. The South Deep shaft is still in the process of being sunk.

The winder parameters of these four winders are given in Table 3, p 28, together with the rope sizes, conveyance masses and payloads for both permanent and kibble winding duties. The information is listed in the same order and has the same meaning as that of the eighteen winder configurations of Tables 1 and 2, described in section 5.2. The rope constructions for the permanent duties were in all cases triangular strand ropes, and non-spin for the kibble winding duties.

Most of the winder information could be obtained, but a few values had to be estimated in the same way as for the winders of Tables 1 and 2.

The BMR of South Deep uses only the one side of each of the drums for kibble winding. Four sheaves will be used in the headgear for permanent winding, while kibble winding requires only two sheaves. For the sake of interest: The two drums of this winder is coupled through a very large universal joint.

The Vaal Reefs 11 "man" winder and the West Driefontein winder each have two calliper brakes. The South Deep BMR has four calliper brakes. The Vaal Reefs 11 "rock" winder has two brake discs with twelve disc brake units divided into three separate brake systems. The layout of this system is described in detail in section C5, p. 38.

The total design brake capacities of the four winders were all assumed to be 4,4 times "Brake OoB". This was confirmed for the Vaal Reefs 11 "rock" winder. The maximum total brake capacity will therefore be 5 times "Brake OoB" in each case.

Brake control failure will lead to the application of 2,5 times "Brake OoB" for the Vaal Reefs 11 "man" winder and for the West Driefontein 9 winder. The Vaal Reefs 11 "rock" winder will apply one third of the total braking effort, i.e. 1,67 times "Brake OoB", after brake control failure. The final configuration of the brake control system of the South Deep BMR winder still has to be installed. If the system consists of two separate brake systems, as is done for most BMR's, brake control failure will result in the application of 2,5 times "Brake OoB". If the system is to consist of four independent and separate brake systems, failure of one control system will only result in the application of 1,25 times "Brake OoB".

The brake efforts listed in the second part of Table 3 were calculated in the same way as described in section 5.3, p. 16, and are:

- "Normal, full and balanced": One conveyance full and the other empty, and the winder in a balanced position. For the values in the kibble duty columns, nothing was attached to one of the ropes.
- "Normal, down full": One conveyance full and the other empty, and the full conveyance descending near the bottom of the shaft. For the values in the kibble duty columns, nothing was attached to the short rope side.
- "Normal, up full": One conveyance full and the other empty, and the full conveyance ascending from the bottom of the shaft. For the values in the kibble duty columns, nothing was attached to the short rope side.

For the "kibble" values, the following: The values in the permanent duty columns are for estimated kibble duties, estimated in the same way as that of the eighteen winder configurations of Tables 1 and 2. The values in the sinking duty columns were based on the actual kibble duties. Estimated kibble duty values were not calculated for the permanent configuration of the BMR winder, because two ropes per kibble are not used (yet).

- "Light kibble, short rope": Empty kibble on the one rope side and nothing on the other side with no out-of-balance and a very short starting rope.
- "Light kibble, full rope, up": An empty or lightly loaded kibble ascending from shaft bottom (final shaft depth) and nothing attached to the short rope side.
- "Full kibble, full rope, up": A full kibble ascending from shaft bottom and nothing attached to the short rope side.

In the kibble duty columns, the "Full kibble, full rope, up" values have to be the same as the "Normal, up full" values.

The estimated kibble duty values compare very well with the actual kibble duty values that were calculated for the three double drum winders. Note that the "Normal, down full" values for the permanent duties are between 2,02 and 2,23 times "Brake OoB". A maximum value of 2,2 times "Brake OoB" was selected for the eighteen winders configurations of Tables 1 and 2.

The rest of the brake effort values in Table 3 are all of the same order as that of Tables 1 and 2. The same conclusions as given in section 5.4, p. 18, are therefore applicable.

The Vaal Reefs 11 "man" winder and the West Driefontein winder will both apply 2,5 times "Brake OoB" during brake control failure. When the out-of-balance assists the brakes, winder decelerations well in excess of $4,5 \text{ m/s}^2$ will be possible after brake control failure on both these winders, and slack rope will occur.

The Vaal Reefs 11 "rock" winder with its disc brakes and current capacity will only generate 1,67 times "Brake OoB" after brake control failure. However, this will not prevent the occurrence of slack rope after brake control failure under all circumstances.

The occurrence of slack rope after brake control failure can be prevented under all circumstances on the South Deep BMR winder if four independent and separate brake systems were to be employed. Brake control failure will then only lead to the application of 1,25 times "Brake OoB". The behaviour of this winder after brake control failure does not differ much between its permanent configuration and the lighter kibble winding duty. This is because of the dominant influence of the rotating masses on the deceleration of a winder.

6. CONCLUSIONS AND RECOMMENDATIONS

Employing current drum winder brake design criteria, a drum winder, with a fully loaded conveyance descending near shaft bottom, will not be able to generate rope forces in excess of 60% of the breaking strength of its ropes after brake control failure. This applies to both permanent drum winders and using these winders for kibble winding during shaft sinking.

If a winder has a (static) safety factor of 3,125 and its fully loaded conveyance ascends from a depth of 4 000 m, rope forces in excess of 60% of the breaking strength of the rope could be generated after brake control failure, but only after slack at the front end of the rope occurred first.

Slack rope can occur after brake control failure at all drum winders currently in operation, whether they are used for permanent winding duties or for shaft sinking. Double drum winders with two brakes are the most susceptible.

The behaviour of large winders after brake control failure do not differ much between performing their rated duties and performing much lighter kibble winding duties. This is because of the dominant influence of the rotating masses on the deceleration of a winder.

It has to be noted that the occurrence of slack rope after brake control failure is possible on all drum winders, and not just on those (future) winders that will have to comply with the requirements of some code of practice. If nothing is to be done to prevent this on winders that do **not** have to comply with the requirements of a code of practice, then, by the same token, the winder codes of practice do not have to specify anything to that extent.

Other than disregarding brake control failures completely or reducing the brake capacity of a two-brake double drum winder to the extent that the winder will not be able to stop on one brake only, there does not seem to be an obvious solution to prevent the occurrence of slack rope after brake control failure. If brake control failures can occur, and if slack at the front end of kibble winder ropes is undesirable, this matter should be investigated further.

The occurrence of slack rope after brake control failure can be prevented on future winders by employing a disc brake design strategy as explained in section C5, p. 38. The regulations governing winder brakes will have to be revised before such systems can be employed.

The analysis of drum winder brake capacities and designs of Appendix C further shows that the regulations governing drum winder brakes are vague. Such regulations cannot contribute to the safety of winding systems. This is a further reason why these regulations should be revised.

The requirement on brake control failures of the winder code of practice¹ may also have to be revised.

7. REFERENCES

1. SABS xxxx:199x: South African Standard: *Code of practice: Mine winding ropes and plant*. (Draft safety standard for the performance, operation, maintenance and testing of mine winding plant.)
2. Hecker, G F K: *Motivation for proposed changes to Chapter 16 of the Minerals Act; Rope safety regulations for drum winders*.
CSIR Contract Report MST(92)MC1674, June 1993.
3. Van Zyl, Mike: *Load ranges acting in kibble winder ropes and proposals for new kibble winder rope regulations*.
CSIR Contract Report MC3127, No. 960348, November 1996.

Table 1: Winder configurations, and braking efforts required for different winder decelerations for normal and kibble winding duties.

	No. 1	No. 2	No. 3	No. 4	No. 5	No. 6	No. 7	No. 8	No. 9
Design depth (m)	1 000	1 000	1 000	2 000	2 000	2 000	3 000	3 000	3 000
Rope diameter (mm)	30	45	60	30	45	60	30	45	60
D/d ratio	100	100	100	100	100	100	100	100	100
Rope tensile grade (MPa)	2 000	2 000	2 000	2 000	2 000	2 000	2 000	2 000	2 000
Rope mass/m (kg/m)	4.095	9.214	16.38	4.095	9.214	16.38	4.095	9.214	16.38
Rope strength (kN)	765	1 721	3 060	765	1 721	3 060	765	1 721	3 060
Mass one rope (kg)	4 095	9 214	16 380	8 190	18 428	32 760	12 285	27 641	49 140
Attached mass (kg)	7 914	17 807	31 658	7 422	16 700	29 689	8 531	19 195	34 125
Conveyance mass (kg)	2 374	5 342	9 497	2 227	5 010	8 907	2 559	5 759	10 238
Payload mass (kg)	5 540	12 465	22 160	5 196	11 690	20 782	5 972	13 437	23 888
Safety factor	6.50	6.50	6.50	5.00	5.00	5.00	3.75	3.75	3.75
Capacity factor	9.86	9.86	9.86	10.52	10.52	10.52	9.15	9.15	9.15
Drum diameter (m)	3.0	4.5	6.0	3.0	4.5	6.0	3.0	4.5	6.0
Drum width (m)	1.3	1.5	2.0	1.6	1.6	2.0	2.4	2.4	2.4
Rope layers	3.0	2.7	2.1	4.5	4.5	3.8	4.5	4.5	4.5
Brake OoB (kN)	118	265	471	153	344	612	204	459	816
Brake OoB torque (kNm)	177	596	1 412	230	775	1 836	306	1 033	2 448
Normal OoB (kN)	94	212	378	131	295	525	179	403	716
Drum inertia (kg m ²)	140 400	546 750	1 728 000	174 474	595 616	1 728 000	255 950	864 871	2 072 895
Sheave inertia (kg m ²)	3 553	13 272	33 806	3 553	13 272	33 806	3 553	13 272	33 806
Motor inertia (kg m ²)	7 082	23 901	56 654	9 838	33 205	78 707	13 419	45 289	107 351
Drum (kg)	62 400	108 000	192 000	77 544	117 652	192 000	113 756	170 839	230 322
Motor (kg)	3 147	4 721	6 295	4 373	6 559	8 745	5 964	8 946	11 928
Sheave (kg)	1 579	2 622	3 756	1 579	2 622	3 756	1 579	2 622	3 756
Total (kg)	87 185	159 542	279 722	111 104	188 020	312 373	158 539	265 265	392 405
Rotating (kg)	69 642	121 935	214 675	90 106	142 639	233 505	132 005	207 426	291 390
% rotating	80	76	77	81	76	75	83	78	74
% payload	6	8	8	5	6	7	4	5	6
% one rope	5	6	6	7	10	10	8	10	13

		118	265	471	153	344	612	204	459	816
Brake OoB (kN)		118	265	471	153	344	612	204	459	816
Revised Brake OoB (kN)		132	265	471	173	344	612	244	459	816
Required braking effort as a multiple of the "Revised Brake OoB" value										
Condition and deceleration										
Normal, full and balanced										
2.25 m/s ²		1.49	1.36	1.34	1.44	1.23	1.15	1.47	1.30	1.08
3.6 m/s ²		2.38	2.17	2.14	2.31	1.97	1.84	2.34	2.08	1.73
4.0 m/s ²		2.64	2.41	2.38	2.57	2.18	2.04	2.60	2.31	1.92
4.5 m/s ²		2.97	2.71	2.67	2.89	2.46	2.30	2.93	2.60	2.16
Normal, down full										
2.25 m/s ²		2.20	2.16	2.14	2.20	2.09	2.01	2.20	2.18	1.96
3.6 m/s ²		3.09	2.97	2.94	3.07	2.82	2.69	3.08	2.96	2.61
4.0 m/s ²		3.36	3.21	3.18	3.32	3.04	2.90	3.34	3.19	2.80
4.5 m/s ²		3.69	3.51	3.48	3.64	3.32	3.15	3.67	3.48	3.04
Normal, up full										
2.25 m/s ²		0.77	0.55	0.53	0.69	0.37	0.29	0.73	0.42	0.20
3.6 m/s ²		1.66	1.37	1.34	1.55	1.11	0.98	1.61	1.20	0.85
4.0 m/s ²		1.93	1.61	1.57	1.81	1.33	1.18	1.87	1.43	1.05
4.5 m/s ²		2.26	1.91	1.87	2.13	1.60	1.44	2.20	1.72	1.29
Light kibble, short rope										
2.25 m/s ²		1.20	1.03	1.01	1.12	0.87	0.79	1.15	0.93	0.71
3.6 m/s ²		1.92	1.65	1.62	1.80	1.39	1.26	1.84	1.48	1.13
4.0 m/s ²		2.13	1.84	1.80	2.00	1.54	1.40	2.05	1.65	1.26
4.5 m/s ²		2.39	2.07	2.03	2.25	1.74	1.57	2.30	1.85	1.42
Light kibble, full rope, up										
2.25 m/s ²		0.92	0.72	0.70	0.79	0.49	0.41	0.82	0.52	0.31
3.6 m/s ²		1.72	1.43	1.40	1.59	1.15	1.03	1.64	1.24	0.89
4.0 m/s ²		1.96	1.64	1.61	1.83	1.35	1.21	1.89	1.46	1.07
4.5 m/s ²		2.25	1.91	1.87	2.13	1.60	1.44	2.19	1.72	1.28
Full kibble, full rope, up										
2.25 m/s ²		0.55	0.31	0.29	0.53	0.20	0.12	0.60	0.27	0.05
3.6 m/s ²		1.42	1.10	1.07	1.38	0.91	0.79	1.47	1.04	0.69
4.0 m/s ²		1.68	1.33	1.30	1.63	1.13	0.98	1.72	1.26	0.87
4.5 m/s ²		2.00	1.62	1.58	1.94	1.39	1.23	2.05	1.54	1.11

Table 2: Winder configurations, braking efforts required for different winder decelerations for normal and kibble winding duties.

	No. 10	No. 11	No. 12	No. 13	No. 14	No. 15	No. 16	No. 17	No. 18
Design depth (m)	4 000	4 000	4 000	2 000	4 000	3 000	3 000	2 000	2 000
Rope diameter (mm)	30	45	60	45	60	45	55	54	43
D/d ratio	100	100	100	100	100	110	110	100	140
Rope tensile grade (MPa)	2 000	2 000	2 000	2 000	2 000	2 000	2 000	2 000	2 000
Rope mass/m (kg/m)	4.095	9.214	16.38	9.214	16.38	9.214	13.76	13.27	8.413
Rope strength (kN)	765	1 721	3 060	1 721	3 060	1 721	2 571	2 479	1 572
Mass one rope (kg)	16 380	36 855	65 520	18 428	65 520	27 641	41 291	26 536	16 826
Attached mass (kg)	5 923	13 327	23 693	20 603	34 398	19 195	28 675	24 048	23 267
Conveyance mass (kg)	1 777	3 998	7 108	6 181	10 320	57 59	8 602	7 214	6 980
Payload mass (kg)	4 146	9 329	16 585	14 422	24 079	13 437	20 072	16 834	16 287
Safety factor	3.50	3.50	3.50	4.50	3.125	3.75	3.75	5.00	4.00
Capacity factor	13.18	13.18	13.18	8.53	9.08	9.15	9.15	10.52	6.89
Drum diameter (m)	3.0	4.5	6.0	4.5	6.0	4.95	6.05	5.4	6.0
Drum width (m)	2.8	2.8	2.8	1.5	2.8	2.2	2.2	1.8	2.0
Rope layers	5.0	5.0	5.0	4.4	5.0	4.5	4.5	4.1	2.7
Brake OoB (kN)	219	492	874	383	979	459	686	496	393
Brake OoB torque (kNm)	328	1 107	2 623	861	2 938	1 136	2 074	1 338	1 183
Normal OoB (kN)	201	453	805	322	878	403	601	425	325
Drum inertia (kg m ²)	303 684	1 020 713	2 433 906	546 750	2 433 906	1 053 403	1 939 012	1 133 741	1 751 155
Sheave inertia (kg m ²)	3 553	13 272	33 806	13 272	33 806	18 091	34 730	24 004	34 173
Motor inertia (kg m ²)	15 087	50 918	120 694	36 217	131 710	49 817	90 956	57 378	48 838
Drum (kg)	134 971	201 622	270 434	108 000	270 434	171 967	211 899	155 520	193 282
Motor (kg)	6 705	10 058	13 410	7 154	14 634	8 133	9 940	7 871	5 390
Sheave (kg)	1 579	2 622	3 756	2 622	3 756	2 953	3 795	3 293	3 772
Total (kg)	185 295	307 959	453 198	184 036	468 339	266 243	349 290	254 310	270 116
Rotating (kg)	158 056	248 535	349 364	133 581	350 588	207 741	263 130	189 926	215 499
% rotating	85	81	77	73	75	78	75	75	80
% payload	2	3	4	8	5	5	6	7	6
% one rope	9	12	14	10	14	10	12	10	6

Table 3: Case studies. * denotes an estimated value.

	V/Reefs #11 Man	V/Reef #11 Rock	West Drie #9	South Deep BMR
Depth (m)	2 340	2 358	1 987	2 760
Rope diameter (mm)	54	54	54	2 x 44
D/d ratio	103	113	102	116
Rope tensile grade (MPa)	2 050	1 900	1 900	1 950
Rope mass/m (kg/m)	12.26	13.07	12.47	2 x 8.42
Rope strength (kN)	2 292	2 430	2 182	2 x 1 520
Mass one rope (kg)	28 688	30 584	24 778	46 478
Attached mass (kg)	23 200	18 240	22 800	29 200
Conveyance mass (kg)	9 200	4 240	10 800	* 12 000
Payload mass (kg)	14 000	14 000	12 000	17 200
Safety factor	4.51	5.08	4.68	4.10
Capacity factor	10.08	13.59	9.77	10.62
Drum diameter (m)	5.55	6.1	5.5	5.1
Drum width (m)	2.0	2.2	1.8	2 x 1.9
Rope layers	4.2	3.5	4.0	4.5
Brake OoB (kN)	509	549	466	742
Brake OoB torque (kNm)	1 411	1 674	1 282	1 891
Normal OoB (kN)	418	474	360	624
Drum inertia (kg m ²)	1 427 366	1 750 000	* 1 217 865	1 914 000
Sheave inertia (kg m ²)	35 260	42 312	* 25 479	* 50 958
Motor inertia (kg m ²)	47 300	56 760	* 49 558	90 000
Drum (kg)	185 357	188 121	161 040	294 348
Motor (kg)	6 142	6 102	6 553	13 841
Sheave (kg)	4 579	4 548	3 369	7 837
Total (kg)	290 434	284 305	257 487	458 019
Rotating (kg)	220 188	222 083	192 371	354 668
% rotating	76	78	75	77
% payload	5	5	5	4
% rope	10	11	10	10
				394 994
				335 113
				85
				4
				7
				10
				10
				466
				* 25 000
				3 845

Brake OoB (kN)	509	549	466	742
Required braking effort as a multiple of the "Brake OoB" value				
Condition and deceleration				
Normal, full and balanced				
2.25 m/s ²	1.29	1.26	1.24	1.23
3.6 m/s ²	2.06	2.01	1.99	1.97
4.0 m/s ²	2.28	2.24	2.21	2.19
4.5 m/s ²	2.57	2.53	2.49	2.46
Normal, down full				
2.25 m/s ²	2.11	2.18	2.02	2.25
3.6 m/s ²	2.88	2.92	2.76	2.97
4.0 m/s ²	3.11	3.14	2.98	3.19
4.5 m/s ²	3.39	3.42	3.26	3.45
Normal, up full				
2.25 m/s ²	0.46	0.30	0.47	0.17
3.6 m/s ²	1.23	1.04	1.22	0.89
4.0 m/s ²	1.46	1.26	1.44	1.10
4.5 m/s ²	1.75	1.54	1.71	1.37
Light kibble, short rope				
2.25 m/s ²	0.91	0.91	0.86	0.87
3.6 m/s ²	1.45	1.45	1.38	1.39
4.0 m/s ²	1.61	1.61	1.53	1.54
4.5 m/s ²	1.82	1.81	1.73	1.73
Light kibble, full rope, up				
2.25 m/s ²	0.52	0.51	0.48	0.46
3.6 m/s ²	1.22	1.21	1.14	1.13
4.0 m/s ²	1.42	1.42	1.34	1.33
4.5 m/s ²	1.68	1.68	1.58	1.58
Full kibble, full rope, up				
2.25 m/s ²	0.24	0.30	0.19	0.17
3.6 m/s ²	0.99	1.04	0.90	0.89
4.0 m/s ²	1.21	1.26	1.12	1.10
4.5 m/s ²	1.49	1.54	1.38	1.37

APPENDIX A: ROPE FORCE CALCULATIONS

The behaviour of winder ropes when accelerations are applied to the winder drum was calculated with the same method used for the kibble winder rope load range report.³ The description of the method is repeated here for the sake of completeness.

A1. THE MODEL

The winding rope, with an attached mass at its end, was approximated as a series of lumped masses and springs. The response of this system to a given input was then calculated at successive time intervals.

A catenary between the winder drum and the headgear sheave was not included for the calculations in this report. The inclusion of a length of rope as a catenary would influence the overall rope stiffness, but does not affect the calculated rope forces significantly (see ref. 3).

Just more than 35 m of travel will be required to stop a winder from 15 m/s at a deceleration of 3 m/s². For this reason the rope length was not adjusted during the calculation of the rope forces. The depth of the conveyance at which braking took place can therefore be interpreted at the average depth during the deceleration of the winder.

A2. ROPE STIFFNESS

The stiffness of the spring elements representing the rope was derived from the elastic modulus of the rope. A *general rope elastic modulus* was derived by Van Zyl* from load-elongation measurements on a large number of rope samples. This elastic modulus was found to be a function of rope stress only, and is given by the following formula:

$$E = k_1 - \frac{k_2}{\sigma + k_3}$$

with: σ	=	rope stress based on the cross sectional steel area of a rope (GPa)
k_1	=	173 GPa
k_2	=	22,7 GPa ²
k_3	=	0,197 GPa

According to the Haggie Rand rope catalogue, the cross sectional steel area of a winder rope is given by the following formula:

$$A = c_a d^2$$

with: A	=	cross-sectional steel area of the rope
c_a	=	0,5 for non-spin ropes
	=	0,454 for triangular strand ropes
d	=	diameter of the rope

* Van Zyl, Mike: *Load ranges experienced by drum winder ropes*. CSIR Contract Report MST(92)MC996, November 1992: Page 6.

The stiffness of a section of rope was calculated using the static rope stress.

A3. ROPE DAMPING

A winder rope has internal damping characteristics. This can be verified by inspection of the data from any set of rope force measurements carried out on a mine winder. Although the exact nature of the internal rope damping has not yet been established, it is essential to include some type of damping for force calculations to obtain realistic results.

A viscous type of damping, represented by the following stress-strain relationship, was included in the model used for the rope force calculations:

$$\sigma = E \left(\varepsilon + \beta \frac{\partial \varepsilon}{\partial t} \right)$$

with: σ	=	Rope stress based on the cross sectional steel area of the rope
E	=	elastic modulus of the rope
ε	=	rope strain
β	=	damping constant
t	=	time

The oscillations (force, displacement) in a rope of a stationary drum winder reduces by half in around five full oscillations. A $\beta = 0,025$ s in the stress-strain relationship above, produces such behaviour. Rope internal damping was provided to the model by incorporating a damper in parallel with each spring.

A4. GENERAL

The accuracy of the numerical model used for the rope force calculations was verified by comparing the results with an analytical method that was developed for the calculation of rope forces generated after the occurrence of slack rope**.

The rope properties (mass, elasticity and damping) are related to the rope cross-sectional area and rope length. This means that if the rope size (area) and attached mass of a winder system are both doubled (or both halved), the dynamic behaviour (period of oscillation and dynamic factors) will remain the same.

** Van Zyl, Mike: *Drum winder rope forces generated by the occurrence of slack rope - a mathematical model*. CSIR Contract Report MST(91)MC867, September 1991.

APPENDIX B: MAXIMUM ROPE FORCES DURING EMERGENCY BRAKING

The kibble winder rope load range report³ gave the following equation for the maximum rope force generated when a winder with a rope and attached mass is decelerated while descending:

$$F_{max} = m_{total} [g + a(1 + \alpha)]$$

with:

F_{max}	=	maximum rope force
m_{total}	=	rope mass plus suspended mass
g	=	gravitational acceleration
a	=	constant deceleration at the drum end
α	=	dynamic amplification factor

For the same deceleration rate, the maximum rope force will have its largest value when the total mass is the largest, i.e. near the bottom of the shaft. In the calculations that follow, the largest mass will be based on the maximum length of suspended rope in the shaft.

Limiting the maximum rope force to a certain fraction of the rope breaking strength gives:

$$F_{max} = \Delta F_{break}$$

with:

F_{break}	=	the breaking strength of the rope
Δ	=	allowable fraction

The (static) rope safety factor (f_{SF}) is by definition:

$$f_{SF} = \frac{F_{break}}{m_{total} g}$$

Substituting the two equations above into the first equation, and rearranging, gives the maximum rope force as a fraction of the rope breaking strength and in terms of the (static) safety factor and the winder dynamics during emergency braking:

$$\Delta = \frac{1}{f_{SF}} \left[1 + \frac{a}{g} (1 + \alpha) \right]$$

For a given, or allowable fraction, the equation can be rearranged to give a required rope safety factor:

$$f_{SF} = \frac{1}{\Delta} \left[1 + \frac{a}{g} (1 + \alpha) \right]$$

The permissible winder deceleration rate can also be expressed in terms of the winder dynamic behaviour, rope safety factor, and allowable fraction:

$$a = \frac{g}{1 + \alpha} (f_{SF} \Delta - 1)$$

In the kibble winder load range report³ it was also shown that a conservative value for the dynamic factor (α) at the back end of the rope was 0,85 for instantaneously applied constant accelerations. Rope forces calculated with this conservative value will not be less than the values calculated with more elaborate methods.

The lowest rope safety factor possible at a depth of 4 000 m is 3,125 as given by the safety factor formula of $25\ 000/(4\ 000 + L)$ of the proposed new drum winder rope regulations.

With the above equations, a deceleration of 4,5 m/s², a safety factor of 3,125 and $\alpha = 0,85$ gives a maximum rope force of 59% of the breaking strength of the rope.

This means that, for braking from a constant descending winding speed, the maximum rope force for any realistic drum winder configuration will be less than 60% of the breaking strength of the winder rope as long as the winder deceleration remains less than 4,5 m/s².

APPENDIX C: WINDER BRAKES

The torque that can be applied by winder brakes is assessed in this appendix. The thermal capacity of the brakes is not considered. Brakes have to have adequate thermal capacity so that the winder can be stopped a number of times in a given period without brake fade.

C1. THE REGULATIONS

The proposed (new) regulations include the following requirements:

- 16.6.1 *Each winding drum or winding sheave shall be provided with an adequate brake(s) which shall be kept in proper working order and shall be capable of-*
- (a) *holding without slipping the conveyance loaded with the maximum load in the maximum out-of-balance position as allowed in the prescribed permit together with an applied torque in the direction of gravity equivalent to the torque required to lift the maximum allowable out-of-balance load; and*
 - (b) *stopping the winder from its permitted speed with its maximum allowable load descending, at a rate such that in conjunction with the safety devices, required in terms of regulation 16.9.1, an approved degree of protection can be maintained.*

"a" above determines the braking power that has to be available, and "b" the controlled rate of deceleration. "a" requires a brake holding power of twice maximum out-of-balance.

A double drum winder has two drums, so does a BMR. Each drum should have at least one brake according to the regulations. The total capacity of the brake(s) on a drum, according to Regulation 16.6.1(a), should be such that two times out-of-balance can be held.

The winder brake regulations above are not clear on what is required for single drum winders and for electrically coupled BMR's (the latter can operate as single drum winders). Should a single drum winder have one or two brakes? If it has two brakes, should the combined capacity be two times out-of-balance, or should each brake have a capacity of two times out-of-balance?

The regulations also do not recognise the benefits of multiple brake units as used on disc brake systems. More about this at the end of this appendix.

C2. WINDER BRAKE CAPACITIES

The brake capacities (or also referred as brake efforts) of this section is based on current practice followed by the designers of winder brakes.

All larger drum winders are equipped with drum-calliper type brakes, except the "rock winder" at Vaal Reefs 11 Shaft, which has disc brakes.

The brake layouts generally used are shown in Table C1. A double drum winder has two brakes, one per drum. BMR winders normally have two brakes per drum, therefore four in total. Single drum winders have two brakes per drum. The maximum torque that winder brakes can generate



(the design brake effort) is normally based on the maximum unclutched out-of-balance of a winder. This value is designated B in Table C1, and is also referred to as the "Brake OoB" value in the rest of this report.

Brakes are normally designed to give slightly more torque (plus 10%) than the two times out-of-balance of the Regulations. The friction coefficient of brake lining materials used in calculating the minimum requirements of the brakes is generally also less than the actual friction coefficients (0,37 compared to 0,43). The actual or maximum braking torque of winder brakes could be up to 15% greater than the design value. These values are also given in Table C1.

As mentioned before, the regulations are not quite clear on what brake capacity is required for single drum winders. To be able to stop the single drum winder when one brake accidentally does not come on, designers normally add more braking; therefore the three times out of balance in Table C1 for the actual total braking power of a single drum winder.

Because the Regulations do not cater for multiple brake units, the disc brakes of the double drum "rock winder" at Vaal Reefs 11 Shaft were designed to have the same total brake capacity of a double drum winder shown in Table C1.

Table C1: Number of brakes and braking power: B = maximum out-of-balance

Winder type	Number of brakes	Capacity of each brake as per Regulations	Design brake effort of each brake	Total design braking effort	Maximum (actual) total brake effort
 Double drum	2	$2B$	$2,2B$	$4,4B$	$5B$
 BMR	4	B	$1,1B$	$4,4B$	$5B$
 Single drum	2	B	$1,3B$	$2,6B$	$3B$

If a winder has two brakes it will be able to stop normally on one brake only. If a winder has four brakes it will be able to stop on two brakes only. This is to provide for the situation where the brake(s) on one drum accidentally do not come on when required.

An electrically coupled BMR will have the same brake capacity on each drum as a single drum winder because it could be operated in single drum configuration.

C3. WINDER BRAKE CONTROL

The actual braking effort required to stop a winder at a given deceleration rate depends on the positions of and loads in the conveyances at the time that the winder has to be stopped. Under certain circumstances the winder could be stopped at the required deceleration rate by the out-of-balance of the winder. A brake control system is required on a winder to ensure that the combination of out-of-balance and brake effort do not produce too high a deceleration rate.

ESCORT brake control and closed-loop brake control will be discussed in this section. The ESCORT system was developed some thirty years ago to overcome the problems experienced

with the old fast-slow brake "control" system. The fast-slow brake "control" system is considered as outdated and will not be discussed.

Schematic layouts of the hydraulics of the ESCORT brake control system and a closed-loop brake control system are shown in Figs C1 and C2, p. 39. A double drum winder, with two calliper brakes, will have two control systems. Normally a BMR also has two control systems, one for each drum, but four control systems can also be employed.

When emergency braking is required, the ESCORT brake control system functions as follows:

- When the brakes are activated, either through the safety circuit or the manual application of the brakes, the pressure, which holds the brakes open, is dumped.
- The "quick drop" takes up all play in the brake system. The "quick drop" is normally set such that zero brake torque is applied. Some mines require that some braking torque be applied through the quick drop, but this is not advisable if a control system is present. The quick drop is achieved within 100 to 200 ms. The quick drop can be achieved through a valve that is normally open when the brakes are off and is closed mechanically by the dropping of the brakes. The quick drop is more often incorporated into the brake cylinder, as is shown schematically in Figs C1 and C2. This system is more robust than a separate quick drop valve.
- The actual braking torque is applied through the ESCORT valves and their orifices. The retardation rate of the winder is measured by the signals obtained from tacho-generators or from any other equivalent system. The ESCORT valves are normally open and will only close once the required winder retardation rate is reached. If the retardation rate of the winder remains greater than the required or set value, the ESCORT valves remain closed, otherwise they will open again to increase the braking effort.
- When the winder stops, the ESCORT valves open and full braking torque is applied.

With all brakes operational, a double drum or BMR winder will at most require 45% of the available braking power to decelerate the winder at $2,25 \text{ m/s}^2$. The ESCORT system will take about 1 second from the time that the brakes are applied until the required deceleration is reached. The two ESCORT orifices of one controller can bleed off the total brake pressure in around 2,5 s, and one orifice will require around 3,5 s.

The brakes will always be applied with an ESCORT system, because the valves are open with the brakes off.

A closed-loop control system operates basically as the ESCORT system, except that the brakes can be opened again if the winder retardation rate is greater than the required or set value. This allows for ramped and "shaped" winder deceleration. Closed-loop systems have proportional valves in place of the ESCORT orifices and valves. The response times of the proportional valves are in the order of 100 ms for normal braking torque, and 200 ms for full braking torque. Currently closed-loop systems have ESCORT systems as back-ups.

The configuration of the hydraulic layouts shown in Figs C1 and C2 are the ones normally used. Other configurations are possible, e.g. coupling the hydraulics of the two control systems between the brake cylinders and the ESCORT valves. If such configurations have advantages over the conventional systems on the electronic control failure side, it inevitably will have

disadvantages on the mechanical control failure side.

C4. UNCONTROLLED BRAKING

For the analysis of the events that could lead to uncontrolled braking, a winder is considered to have independent and separate brake control systems, each consisting of:

- A tacho-generator or equivalent that will supply the signals from which the retardation rate of the winder can be determined.
- An electronic control system that determines the retardation rate and controls the applications of the brakes to obtain the desired winder deceleration.
- A hydraulic system that applies the brake(s).

The hydraulic systems are separate, except for the couplings as shown in Figs C1 and C2.

If a brake fails to come on for some reason or component failure, the other brake system(s) of the winder will still stop the winder in a controlled way. Only the failures that will lead to uncontrolled braking is considered in this appendix.

The failure of only one brake component at a time is considered. Winder brake systems are normally constructed such that it would not be possible during emergency braking for all the winder brakes to be applied in full at the same time.

The possible brake control failures that follow are not exhaustive, but should give a fair indication of the effects of brake control failures.

Hydraulic pipe failures have occurred in the past and can therefore not be excluded from a list of possible failures. If a pipe failure is on the down-side from the control valves, it will have the same effect as a normal trip-out. If the pipe failure occurs between the brake cylinder and the control valve, the brake(s) controlled by that system will come on fully and immediately. The following brake efforts, expressed in terms of brake design parameter "Brake OoB", will be applied for different brake configurations. The maximum brake capacities are as given in Table C1:

- 2,5 times for a double drum winder with two brakes and two control systems.
- 2,5 times for a BMR or double drum with four brakes and two control systems.
- 1,25 times for a BMR or double drum with four brakes and four control systems.
- 1,67 times for a double drum with three brakes and three control systems.
- 1,5 times for a single drum or electrically coupled BMR with two brakes and two control systems per drum.

A single drum winder will have an inertia of approximately half of a double drum winder. The effect of the 1,5 times "Brake OoB" could therefore be just as severe as 2,5 times for a double drum winder. The drums of single drum winders are normally "beefed up" to increase the drum inertia to get the winder behaviour more in line of that of double drum winders.

A failure that will be more common than a hydraulic pipe failure, is a brake control valve failure or a controller failure (tacho or electronic) that will result in a control valve remaining open.

In the case of an ESCORT system, the following could be sequence of events: All the ESCORT valves are open and remain open after the brakes are activated. When the required retardation

rate is reached, the valves will close. If one valve remains open, full braking effort will be applied by the one brake, while the other brake(s) still apply the normal retardation effort. The sum total of the brake effort depends on the out-of-balance of the winder at the time of the application of the brakes. With maximum normal out-of-balance and the heavy side descending, the total effort could be of the order of 3,5 times "Brake OoB" for a double drum winder with two brakes. If the heavy side is ascending the normal retardation brake effort will be less, because the out-of-balance assists the brakes. The total brake effort could then be between 2,5 and 3 times "Brake OoB". In ESCORT systems, some time is required (2,5 to 3,5 s) for the brake pressure to drop off for full brake effort to be applied. The actual winder deceleration and resulting rope forces may therefore not be more severe than for the hydraulic pipe failure case.

With a closed-loop control system, failure of a control valve in the open position will result in that brake being applied fully almost immediately. The remaining control system(s) will sense that the winder deceleration is too high and will therefore open the other brake(s). The combined effect will therefore be the same as in the case of a hydraulic pipe failure where one brake is applied in full.

C5. MULTIPLE BRAKE SYSTEMS

With the disc brake units that are now available to the mining industry in South Africa, emergency brake systems can be configured that will have behaviours very different to the calliper brake systems currently employed. These configurations will, of course, only be available to new winder designs.

The disc brake winder at Vaal Reefs 11 Shaft has two discs on its double drum, and two brake "posts" per disc. Each brake post has three disc brake units, which gives twelve units in total. This winder has three separate brake control systems, with each of the three disc units at a brake post connected to a different brake control system. The result of this setup is that three brakes are always available on each side of the double drum winder.

The first advantage of this system is that thermal capacity of the brakes are not lost under any circumstance. If one brake on a double drum winder fails to be applied, the other brake has to do all the work and all the energy has to be dissipated in the one brake path. If the same happens with the Vaal Reefs system the other two brakes systems still apply the brake effort on both discs, thereby making full use of the available thermal capacity of the brake paths.

For a double drum winder in the unclutched position, the failure of the brake of the moving drum will result in no braking at all. With the three brake system, two brakes systems will still be available on that side of the drum. For this situation, the three brake system is infinitely more safe and reliable.

The regulations governing the capacities of winder brakes do not take the advantages of multiple brake units on disc brake systems into account. The total brake effort of the Vaal Reef 11 Shaft rock winder was therefore designed to have the same total brake effort as an ordinary drum winder.

The design brake effort of that system need only to be such that two brakes systems should be able to give 2,2 times "Brake OoB" to be in line with the design of the brakes for double drum winders with calliper brakes. The maximum brake effort of a single brake system will then only be 1,25 times "Brake OoB". The effect of failure of a control system, which results in the application of one brake in full, will then be less severe than with the current brake capacity.

Extending this to four independent brake systems will require that three brakes need to be able to apply 2,2 times "Brake OoB". Each brake system will then have a maximum capacity of 0,83 "Brake OoB". Failure of one brake control system will then be even less severe.

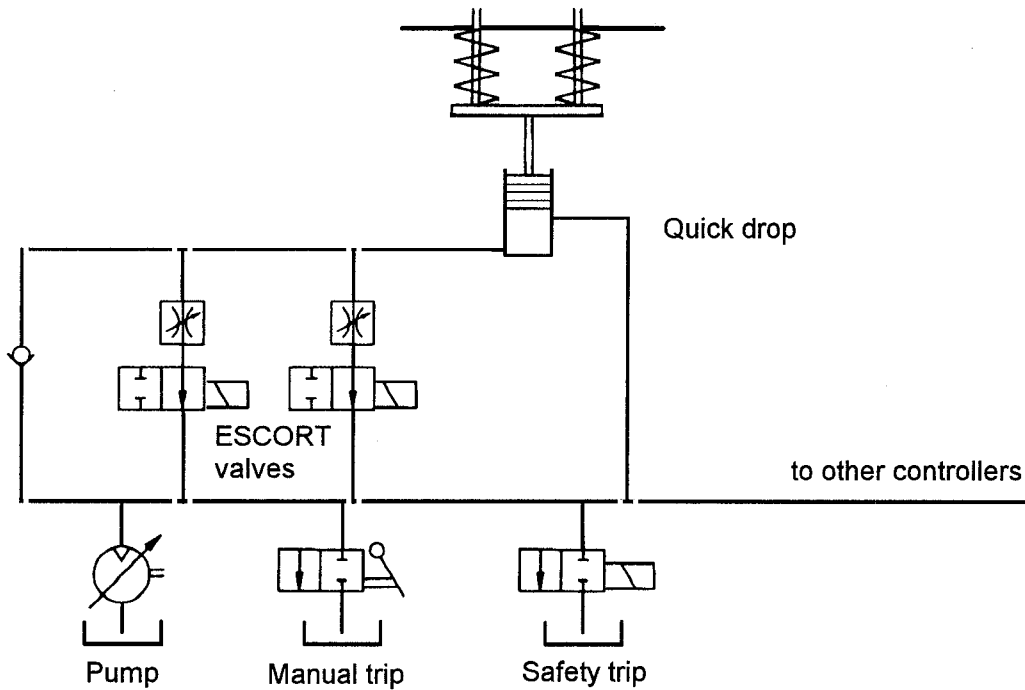

Figure C1: Schematic layout of the hydraulics of an ESCORT brake control system.

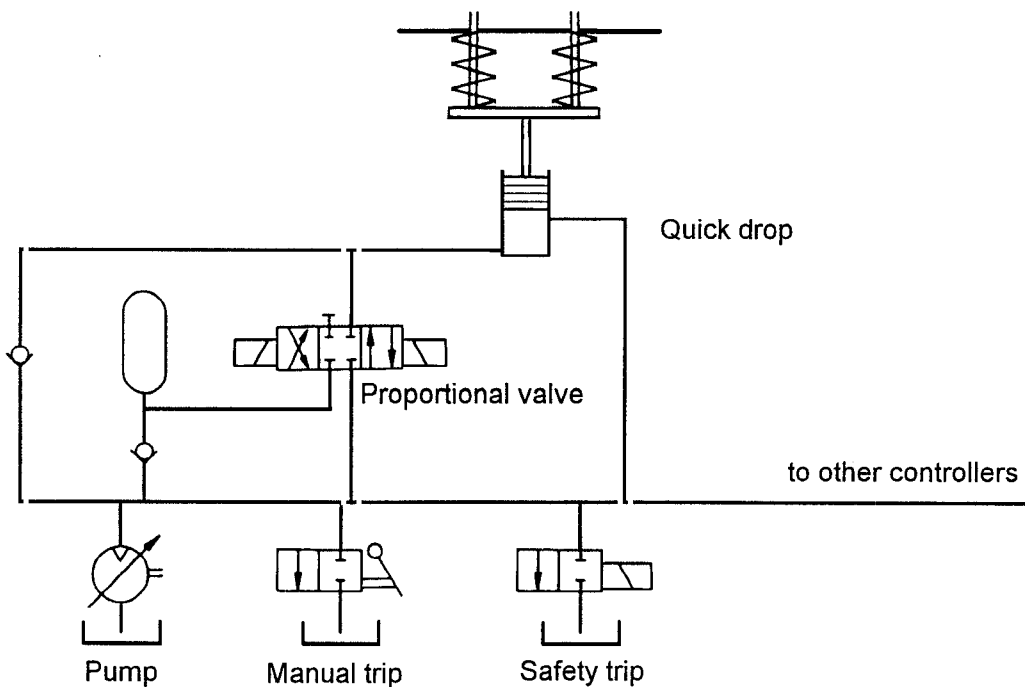

Figure C2: Schematic layout of the hydraulics of a closed-loop brake control system.

APPENDIX D: WINDER DRUM INERTIAS

Winder drum inertias, together with other relevant winder data, were obtained from various sources. The data are listed in Table D1.

The winders in Table D1 cover a wide range of winder sizes and shaft depths. The inertia listed for a BMR winder is for both drums. The listed "drum width" is the width of the coiling part of one rope. The total coiling width of the one drum of a BMR winder will therefore be twice the listed value.

Table D1: Winder sizes, drum inertias, and general winder data.

Source	Type	Drum diameter (m)	Drum width (m)	Drum inertia (10^6 kg m ²)	Depth (m)	Rope diameter (m)	Rope layers	Payload (kg)	Skip mass (kg)
a	DD	7,29	2,60	5,47	3 000	54	3,1	7 260	3 630
a	BMR	4,61	3,20	1,63	3 000	2 x 43	3,1	14 270	7 135
a	BMR	6,54	3,40	9,10	3 500	2 x 54	3,0	10 930	5 465
a	BMR	7,00	3,60	11,90	4 000	2 x 55	3,1	10 990	5 495
a	BMR	9,34	2,80	21,70	4 000	2 x 55	3,0	13 180	6 590
d	DD	4,88	1,83	0,92	1 800	50	3,7	-	-
d	DD	5,50	1,83	1,25	2 000	53	3,9	-	-
d	DD	5,50	2,00	1,43	2 500	53	4,3	-	-
d	DD	6,00	2,20	2,00	2 500	60	4,1	-	-
d	BMR	4,27	2,00	1,30	2 300	2 x 43	4,1	-	-
d	BMR	4,57	1,30	1,00	2 000	2 x 45	5,5	-	-
d	BMR	5,10	1,90	1,92	2 400	2 x 48	4,2	-	-
d	BMR	8,50	2,80	16,93	4 000	2 x 64	3,8	-	-
s	DD	5,54	2,00	1,06	2 220	48	3,5	12 500	8 800
s	DD	6,04	2,20	1,84	1 900	63	3,3	16 625	9 975
s	BMR	4,61	1,30	0,98	1 350	2 x 45	3,8	14 000	7 000
s	BMR	6,04	2,00	4,20	2 500	2 x 58	4,3	30 000	10 500
s	BMR	6,54	2,50	6,60	2 900	2 x 57	3,6	25 500	12 750
s	BMR	6,54	2,50	5,78	2 900	2 x 57	3,6	25 500	12 750
j	DD	4,97	1,83	0,88	2 800	35	3,9	5 000	6 500
j	BMR	5,10	1,90	1,91	2 800	2 x 44	4,6	17 200	8 100
v	DD	5,55	2,00	1,43	2 400	54	4,3	14 000	10 000
v	DD	6,10	2,20	1,75	2 400	54	3,6	19 000	8 000

The information in Table D1 was obtained from the following sources:

"a" - This data were obtained from a report by M E Greenway: *An engineering evaluation of the limits to hoisting from great depth*, Mechanical Engineering Department, Anglo American Corporation, June 1990. The inertia values listed are the total winder inertias and include the winder motor(s). None of these winders were built. They were evaluated for the purposes of that report.

"d" - The information of these winder were obtained from Dorbyl Heavy Engineering. Apart from the 8,5 m diameter winder, the data are from actual winders.

"s" - The information of these winders were obtained from Siemens, and were supplied to Siemens by their clients for the purposes of winder motor size calculations.

"j" - Actual winder data obtained from JCI.

"v" - Actual winder data obtained from Vaal Reefs 11 Shaft.

According to Errol Sparg of Dorbyl Heavy Engineering, the inertia of a winder drum is approximately proportional to the product of the drum width and the cube of the drum diameter. This can be written in equation form as follows:

$$I_d = n C_{id} w_d d_d^3$$

with: I_d = winder drum inertia
 n = 2 for the inertia of a double drum winder
 = 2 for one drum (or side) of a BMR winder
 = 4 for the total drum inertia of a BMR winder
 C_{id} = a constant for the calculation of winder drum inertias
 w_d = the coiling width of one rope on a drum
 d_d = the diameter of the winder drum, and is normally the diameter of the part on which the rope is coiled.

The value for the drum inertia constant (C_{id}) was calculated for each of the winders listed in Table D1. These values are given in Table D2 together with estimated values for the inertias calculated with $C_{id} = 2\ 000\ \text{kg/m}^2$.

The second winder in Table D2 has a low drum inertia. When the inertia of this winder was calculated, one half of the width was most probably used, or the wrong width was listed in the report from which that data was sourced.

The drum inertias of all actual winders are quite well approximated using $C_{id} = 2\ 000\ \text{kg/m}^2$, except for the last winder in Table D2. This winder is equipped with disc brakes, which is the most probable reason for the lower drum inertia.

Table D2: Drum inertia constants and estimated drum inertias with $C_{id} = 2\,000\text{ kg/m}^2$

Source	Type	Drum diameter (m)	Drum width (m)	Drum inertia (10^6 kg m^2)	C_{id} (kg/m^2)	Estimated inertia (10^6 kg m^2)
a	DD	7,29	2,60	5,47	2 720	4,03
a	BMR	4,61	3,20	1,63	1 300	2,51
a	BMR	6,54	3,40	9,10	2 390	8,06
a	BMR	7,00	3,60	11,90	2 410	9,88
a	BMR	9,34	2,80	21,70	2 380	18,25
d	DD	4,88	1,83	0,92	2 160	0,85
d	DD	5,50	1,83	1,25	2 050	1,22
d	DD	5,50	2,00	1,43	2 150	1,33
d	DD	6,00	2,20	2,00	2 100	1,90
d	BMR	4,27	2,00	1,30	2 090	1,25
d	BMR	4,57	1,30	1,00	2 010	0,99
d	BMR	5,10	1,90	1,92	1 900	2,02
d	BMR	8,50	2,80	16,93	2 460	13,76
s	DD	5,54	2,00	1,06	1 560	1,36
s	DD	6,04	2,20	1,84	1 900	1,94
s	BMR	4,61	1,30	0,98	1 910	1,02
s	BMR	6,04	2,00	4,20	2 380	3,53
s	BMR	6,54	2,50	6,60	2 360	5,59
s	BMR	6,54	2,50	5,78	2 070	5,59
j	DD	4,97	1,83	0,88	1 950	0,90
j	BMR	5,10	1,90	1,91	1 900	2,02
v	DD	5,55	2,00	1,43	2 090	1,37
v	DD	6,10	2,20	1,75	1 750	2,00

APPENDIX E: WINDER MOTOR INERTIAS

E1. MOTOR INERTIAS

Winder motor inertias were obtained from Siemens. The inertias are given in Tables E1, E2 and E3, together with other relevant data for synchronous, induction, and DC motors. The information in the tables are all for directly coupled motors.

According to Siemens, the inertia of a winder motor is approximately proportional to the rated torque of the motor. Therefore:

$$I_m = C_{im} T_m$$

with: I_m = winder motor inertia
 C_{im} = a constant for the calculation of winder motor inertias

The values of the constant, C_{im} , for each of the motors in Tables E1, E2 and E3 are also shown in the tables. The motor speeds are all of the same order of magnitude, and the motor inertia therefore appear to be proportional to the power as well.

Figure E1 shows a plot of the calculated values of the constant, C_{im} , against motor torque for all the listed motors. The values range from 10 to 90 $\text{kg}\cdot\text{m}^2/\text{kNm}$ for the smaller motors, and from 40 to 70 $\text{kg}\cdot\text{m}^2/\text{kNm}$ for the larger motors, and have an average of 50 $\text{kg}\cdot\text{m}^2/\text{kNm}$.

Motor inertias are far smaller than winder drum inertias. The largest motor listed in this appendix has an inertia of only 15% of the smallest drum inertia listed in Appendix D.

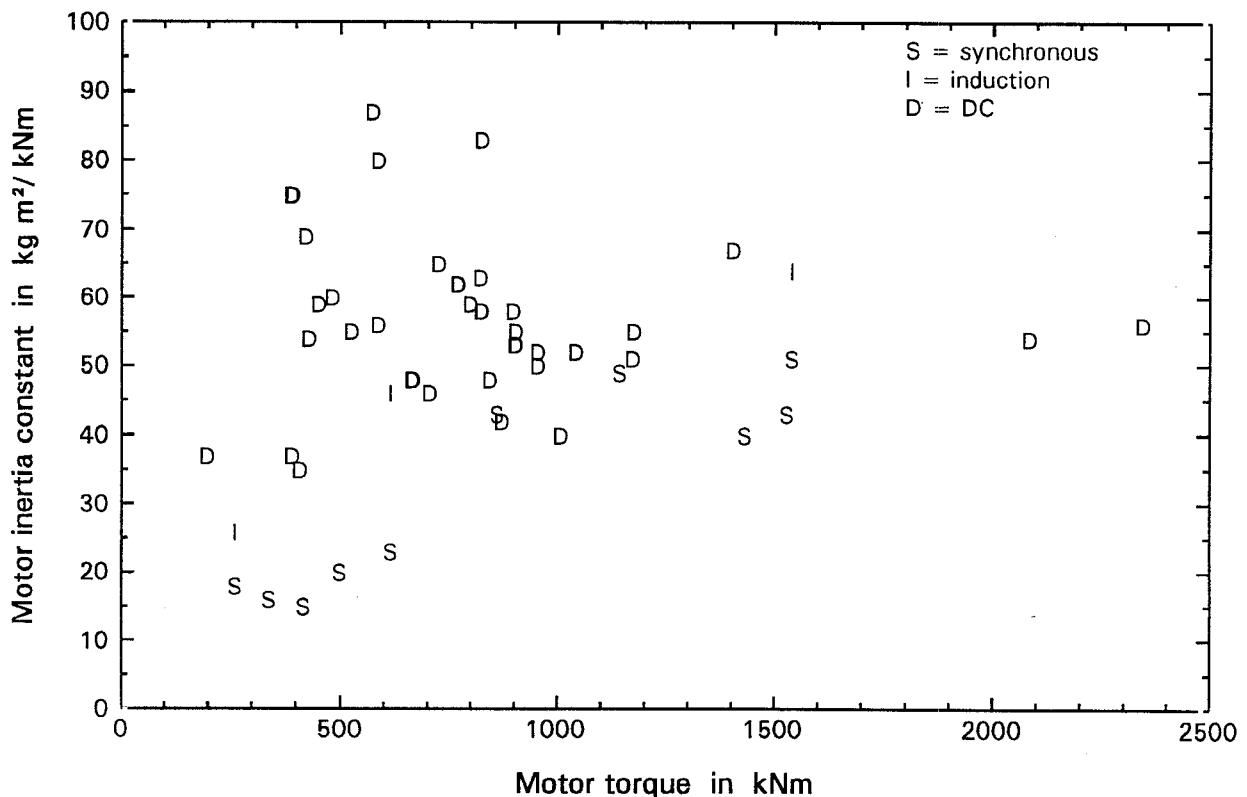

Figure E1: Winder motor inertia constant, C_{im} , plotted against motor torque.

E2. MOTOR POWER AND TORQUE

The inertia added to the winding system by the winder motor, is determined by the size of the motor. A simple method of estimating the winder motor size is described in this section.

The winder motors required for a number of shafts and operating conditions were calculated with a computer program made available by Siemens. The winder and shaft data, together with the calculated winder motor power and torque are given in Table E4.

The inertia of the winder drum was calculated with the method given in Appendix D. The total winder inertia is the sum of the drum inertia plus that of the motor(s) and the headgear sheaves. For the purposes of the calculations an inertia of 45 000 kg·m² was used for each sheave. A motor inertia of 50 000 kg·m² was used in all cases. This would be the inertia of a motor with a rated torque of approximately 1 000 kNm.

The RMS-power of a winder motor is generally determined by the duty cycle of the winder. The peak torque is determined by the total mass that has to be accelerated (inertias plus masses) and the out-of-balance torque of the winder. Peak values are normally in the range of 1,8 to 2,2 times the RMS values.

Winder motors are normally selected with slightly more power than the calculated RMS values so that the motor will have some reserve power, and for reasons of standardization. The over-rating factor is normally 15% to 30%.

The maximum (static) winder out-of-balance torque values in Table E1 are generally 15% to 40% greater than the RMS torque of the different motors. The maximum winder out-of-balance torque should therefore be much the same as the rated torque value of a winder motor. The rated motor power is obtained by multiplying the maximum out-of-balance force by the winding speed.

The rated torque of a winder motor can therefore be estimated by simply using the maximum out-of-balance of the winder system. The inertia of the winder motor can then be estimated using a value of 50 kg·m²/kNm for the winder motor inertia constant of section E1. The motor inertias so estimated range from 2,5% to 3,5% of the value of the total winder inertias given in Table E4.

Table E1: Synchronous motors

Rated power (kW)	Speed (rpm)	Rated torque (kNm)	Inertia (kg m ²)	C_{im} (kg m ² /kNm)
7 300	45.3	1 539	79 000	51
8 060	50.4	1 528	65 500	43
8 800	58.8	1 429	57 000	40
6 600	55.2	1 142	55 800	49
4 500	50.0	859	36 600	43
3 600	56.0	614	14 100	23
3 800	73.0	497	9 800	20
2 700	62.0	416	6 400	15
2 350	54.0	416	6 400	15
2 300	65.0	338	5 420	16
1 800	66.0	260	4 600	18

Table E2: Induction motors

Rated power (kW)	Speed (rpm)	Rated torque (kNm)	Inertia (kg m ²)	C_{im} (kg m ² /kNm)
7 300	45.3	1 539	98 000	64
3 600	56.0	614	28 300	46
1 800	66.0	260	6 850	26

Table E3: DC motors

Rated power (kW)	Speed (rpm)	Rated torque (kNm)	Inertia (kg m ²)	C_{im} (kg m ² /kNm)
13 500	55.0	2 344	131 650	56
12 000	55.0	2 084	111 900	54
9 500	64.7	1 403	94 500	67
5 400	62.5	825	68 100	83
5 975	48.5	1 176	65 260	55
6 750	55.0	1 172	60 050	51
6 000	55.0	1 042	54 040	52
5 586	59.5	897	51 800	58
4 000	46.5	822	51 800	63
3 600	60.0	573	49 900	87
4 975	49.8	955	49 400	52
4 710	49.8	904	49 400	55
6 440	64.4	955	47 610	50
6 100	64.6	902	47 610	53
5 570	64.7	823	47 610	58
5 400	62.5	825	47 610	58
5 200	64.6	769	47 610	62
5 200	64.4	771	47 610	62
4 710	49.8	904	47 610	53
2 988	48.5	587	47 000	80
4 493	53.8	798	46 800	59
4 085	53.8	725	46 800	65
5 380	51.0	1 007	40 700	40
4 500	51.0	843	40 700	48
5 020	55.0	872	36 710	42
2 988	48.5	587	32 910	56
4 130	56.0	705	32 100	46
3 910	56.0	667	32 100	48
4 060	58.4	664	31 600	48
3 000	73.0	392	29 400	75
3 280	65.0	482	29 150	60
2 650	65.0	389	29 150	75
4 015	73.0	525	29 100	55
3 176	72.0	421	29 100	69
2 357	50.1	450	26 700	59
1 760	39.1	429	23 000	54
3 150	73.7	408	14 400	35
2 500	61.2	390	14 400	37
1 800	87.0	198	7 272	37

Table E4: Winder data, required RMS torque and power, and maximum out-of-balance torque.

Winder no. and type	No. 1 Double drum	No. 2 Double drum	No. 3 Double drum	No. 4 Double drum	No. 5 Double drum	No. 6 Double drum	No. 7 BMR	No. 8 Double drum	No. 9 BMR	No. 10 Double drum
Depth (m)	1 000	1 000	2 000	2 000	2 500	3 000	3 000	3 000	4 000	4 000
Conveyance (kg)	5 500	10 000	5 500	9 000	7 000	4 000	11 000	8 000	8 000	7 000
Payload (kg)	8 500	16 000	8 500	17 000	13 000	7 000	20 000	16 000	16 000	12 000
Rope dia. (mm)	40	55	40	55	55	40	48	60	48	60
Rope mass (kg/m)	6,78	13,1	6,78	13,1	13,1	6,78	9,8	15,0	9,8	15,0
Strength (kN)	1 260	2 400	1 260	2 400	2 400	1 260	1 800	2 800	1 800	2 800
Ropes/conveyance	1	1	1	1	1	1	2	1	2	1
Capacity factor	9,2	9,4	9,2	9,4	12,2	11,7	11,8	11,9	15,3	15,0
Safety factor	6,2	6,3	4,7	4,7	4,6	4,1	4,1	4,1	3,6	3,6
Drum dia. (m)	4,5	6,0	4,5	6,0	6,0	5,0	6,0	6,0	6,0	6,0
Width (m)	1,3	1,3	1,8	2,0	2,4	2,5	2,5	3,0	3,0	4,0
Speed (m/s)	16,0	16,0	16,0	15,0	18,0	16,0	18,0	16,0	18,0	18,0
Acc. (m/s ²)	0,75	0,75	0,80	0,80	0,80	1,00	0,75	0,80	0,75	0,70
Total winder inertia (10 ⁶ kg m ²)	0,61	1,26	0,80	1,87	2,21	1,39	4,51	2,73	5,37	3,60
RMS torque (kNm)	327	746	405	956	1 061	547	915 x 2	1 289	1 057 x 2	1 574
RMS power (kW)	2 270	3 882	2 792	4 627	6 160	3 404	5 339 x 2	6 635	6 163 x 2	9 118
Peak torque (kNm)	620	1 404	883	2 095	2 251	1 390	1 974 x 2	2 943	2 338 x 2	3 378
Peak power (kW)	4 302	7 304	6 087	10 140	13 077	8 645	11 514 x 2	15 153	13 636 x 2	19 563
Peak/RMS	1,90	1,88	2,18	2,19	2,12	2,54	2,16	2,28	2,21	2,15
Out of balance:										
Max force (kN)	150	285	216	423	448	268	772	598	925	706
Max torque (kNm)	337	855	486	1 270	1 345	670	2 317	1 793	2 775	2 117
Out-of-balance greater than RMS torque	3%	15%	20%	33%	27%	22%	27%	39%	31%	34%

Appendix EE: Triangular strand ropes for deep shaft operations - an initial study

CONTENTS

	Page
1. INTRODUCTION	1
1.1 PRINCIPAL BEHAVIOUR OF A TRIANGULAR STRAND ROPE	1
1.2 ADVANTAGES OF TRIANGULAR STRAND ROPES	1
1.3 ANTICIPATED TRIANGULAR STRAND ROPE PROBLEMS	2
1.4 THE INVESTIGATION OF THIS REPORT	3
2. THE LORAINE EXPERIENCE	4
2.1 WINDER AND ROPE PARAMETERS	4
2.2 ROPE HISTORY	4
2.3 ROPE LAYLENGTH AND DIAMETER	5
2.4 PHYSICAL APPEARANCE OF THE ROPES	7
2.5 OTHER OBSERVATIONS	7
3. CALCULATION OF ROPE BEHAVIOUR	8
3.1 TORQUE-TENSION-TWIST CHARACTERISTICS	8
3.1.1 Torque-tension-twist relationship	8
3.1.2 Twist-elongation-laylength relationship	11
3.2 BEHAVIOUR OF A VERTICALLY SUSPENDED ROPE	13
3.2.1 Derivation of equations	13
3.2.2 An example calculation	15
3.3 LETTING OUT SPIN	16
4. COMPARISON WITH THE ACTUAL ROPE BEHAVIOUR	18
4.1 INITIAL COMPARISON	18
4.2 ADJUSTED ROPE CONSTANTS	19
4.3 RE-CALCULATION OF ROPE BEHAVIOUR	20
4.3.1 As installed	20
4.3.2 After letting out spin	21
4.4 COMPARISONS BASED ON THE ADJUSTED ROPE CONSTANTS	23

5.	PREDICTED DEEP SHAFT BEHAVIOUR	24
5.1	ROPE TWIST AND LAYLENGTH LIMITS	24
5.2	A 3 200 m DEEP SHAFT	24
5.3	A 4 000 m DEEP SHAFT	26
5.4	LARGER ROPE DIAMETERS	26
5.5	DEEP SHAFT ROPE LOADS	27
6.	MODIFIED TRIANGULAR STRAND ROPE DESIGNS	28
7.	CONCLUSIONS	30
8.	RECOMMENDATIONS	31
9.	REFERENCES	32

1. INTRODUCTION

Nearly all permanent drum winders in this country use triangular strand ropes. The greatest depth of a single lift shaft is currently just less than 2 500 m. The torque-tension characteristics of triangular strand ropes cause laylength changes in the rope when installed in a shaft, and cause torque to be generated at the fixed rope ends. The rope torque increases and the laylength changes become more severe with increasing shaft depths. The general belief of the mining industry is that the laylength changes and the generated torque will limit the depth at which triangular strand ropes can be used.

The investigation described in this report is part of the SIMRAC project, GAP 324 (1996). In this initial study, the possibility of using triangular strand ropes at depths greater than current experience is investigated. This report examines how a triangular strand rope could behave in ultra deep shafts, and analyses potential problems that could be experienced under such operating conditions.

1.1 PRINCIPAL BEHAVIOUR OF A TRIANGULAR STRAND ROPE

The torque-tension-twist characteristics of a triangular strand rope and its actions when installed in a vertical shaft are discussed in detail later in this report. What follows is an introduction to the behaviour of these ropes.

A triangular strand rope generates substantial torque when loaded. If an end of a triangular strand rope section is free to rotate when loaded, the rope will unlay to reduce the torque to zero.

When a triangular strand rope is installed in a shaft, the drum end of the rope will be subjected to a higher load than the conveyance end, because of the mass of the rope. The drum end (back end) of the rope will therefore generate a greater torque than the conveyance end (front end). However, the torque throughout the length of rope in a shaft has to have the same value, because the rope is only restrained at its ends. The back end of the rope will therefore unlay to reduce its torque, and the front end of the rope will lay up to increase its torque. Torque equilibrium is established in this way. Around mid-shaft, the rope will retain its as-manufactured laylength.

The torque generated by the rope in the shaft will be (approximately) equal to the torque that will be generated by a sample of rope subjected to the midshaft load, and without applying any rotation at the ends of the rope sample.

1.2 ADVANTAGES OF TRIANGULAR STRAND ROPES

Triangular strand (Lang's lay) ropes are preferred for permanent drum winding operations because of the following:

- High resistance to crushing.
- High resistance to "fatigue" because of the absence of inter-strand nicking points.
- Large wear areas which make it suitable for multi-layer drum coiling.
- Less internal rope corrosion because of the non-metallic core.
- Higher strength to mass ratio than non-spin rope constructions.
- Lower cost compared to non-spin type rope constructions.
- Broken wires appear mostly on the surface of the rope.
- Electro-magnetic testing is more reliable because of the absence of a wire main core.

- Rope discard criteria are well established.
- The torque-tension-twist characteristics result in even wear around the rope circumference.
- Proven performance on drum winders.
- Stable construction. The rope has only one layer of strands. Relative slip between strand layers cannot occur.

If triangular strand ropes are not found suitable for ultra deep shaft operations, it will be because of laylength changes in the ropes and torque generated by the ropes. Non-spin rope constructions, which have much lower external torque generating characteristics, will therefore have to be used.

The mining industry in this country has very limited experience with non-spin ropes operating on permanent drum winder installations. Suitable alternative rope constructions to triangular strand ropes have not yet been established.

1.3 ANTICIPATED TRIANGULAR STRAND ROPE PROBLEMS

Some problems that could be experienced when triangular strand ropes are used in ultra deep shafts have been mentioned in the sections above. These and other problems that are currently anticipated are:

- The crushing resistance of ropes with long back end laylengths:

In an experiment carried out by Haggie Rand,¹ a 28 mm diameter 6x29 triangular strand rope was wound onto a drum with a flat surface at 25% of its breaking strength and at different laylengths. The ovality of the rope was measured for the different laylengths. It was found that the ovality started to increase quite rapidly at laylengths longer than the as-manufactured value plus 80%. This could be an indication of when a rope starts to become unstable to laterally applied forces.

The drums of a winder on a deep shaft will not be flat (smooth), but will have coiling sleeves. A rope will therefore have better support than a flat surface as used in the Haggie Rand experiment. Subsequent rope layers on the drum will be coiled into the valleys formed by the underlying rope layer, which will also give better support than a flat surface. Headgear sheaves are also shaped for the specific rope diameter and will therefore also provide adequate support.

Although ropes in service will have better support than a flat surface, the 80% increase in laylength "limit" as determined during the Haggie Rand experiment should be observed.

- The "fatigue" behaviour of ropes with long back end laylengths:

The distortion of a triangular strand rope from its as-manufactured condition to produce a long laylength could lead to uneven load sharing between the different components of the rope strands. The higher loaded parts of a strand could therefore become more susceptible to "fatigue" (crack initiation and generation of broken wires).

- Short front end laylength combined with large rope torque:

A triangular strand rope can be unlaidd until the strands are straight, but there are physical (geometrical) limits to the amount that the laylength of a rope can be shortened. If the laylength becomes too short, there will not be enough space for the six strands to fit into

a laylength. Ropes forced past the physical limits by large rope torques could distort ("corkscrew" or kink).

From pure geometrical considerations (calculations not shown), the decrease in laylength limit is estimated at 20% shorter than the norm (as-manufactured). (The laylength norm for Haggie Rand ropes is around 8 rope diameters.)

- The effect of greater-than-normal rope torque:

Rope front ends subjected to high rope torque will be more susceptible to kinking when the front end of the rope experiences slackness.

An increase in rope torque will increase the stress levels in a rope, which could increase rope "fatigue".

An increase in rope torque will result in higher forces on the conveyance guide rollers and shaft steelwork.

1.4 THE INVESTIGATION OF THIS REPORT

When this project was planned originally, the major concern was whether the drum end of a triangular strand rope, which would have a longer-than-normal laylength, will remain stable when wound onto a drum. Because a suitable winder on which a long back end laylength could be introduced artificially could not be located, the investigation was shelved. The project was restarted after it was brought to the attention of the author of this report that a winder at Loraine Gold Mine had a long back end laylength introduced by accident.

This report describes the Loraine experience, compares the rope laylengths of that winder with values calculated from laboratory measured torque-tension-twist characteristics, and compares the laylengths with values that could be expected in ultra deep shafts.

2. THE LORAINE EXPERIENCE

A long laylength was accidentally introduced in the underlay rope of the "Barlows" winder at Loraine No. 3 Shaft. Problems with the skip in the loading bay area necessitated the detaching of the rope from the skip. This, of course, resulted in the end of the rope spinning until a zero rope torque condition was established throughout the length of the rope.

2.1 WINDER AND ROPE PARAMETERS

The winder and rope parameters of the "Barlows" winder at Loraine No. 3 shaft are listed in Table 1. The winder drums were equipped with coiling sleeves, which gave crossovers every 180°.

Table 1: Winder and rope parameters

Winder permit no.	5095
Suspended rope length	1 825 m
Drum diameter	3,96 m
Sheave diameter	4,27 m
Rope diameter (nominal)	39 mm
Rope construction	6x29 Δ
Rope mass	6,57 kg/m
Rope tensile grade	1 900 MPa
Rope strength	1 200 kN
Skip mass	3 808 kg
Rock mass	6 500 kg
Total attached mass	10 308 kg
Capacity factor	11,9
Safety factor	5,5

2.2 ROPE HISTORY

The ropes were installed on 2 April 1993, and were still in operation at the time of the writing of this report, more than 4 years later. The underlay rope lost spin in August 1994, one year and four months after installation. According to the rope record book of the mine, front and back ends were cut as follows:

Front ends: Every six months.
 Back ends: One year after installation (April 1994), 1½ years later (October 1995), and then 7 months after that (May 1996).

The condition of the ropes were assessed with the aid of electromagnetic testing in April 1997. Although both ropes had extensive plastic deformation at their back ends, the total number of broken wires over the full rope length was approximately 30 for the overlay rope and 20 for the underlay rope. None of the two ropes had more than one broken wire in any five rope laylengths. Of interest is the fact that the underlay rope, which lost the spin, was in a slightly better condition than the overlay rope.

2.3 ROPE LAYLENGTH AND DIAMETER

The rope laylengths and diameters were measured by Loraine personnel during the monthly rope inspections. The first measurements were carried out approximately two weeks after installation. As-manufactured and zero load measurements were not available.

The monthly rope inspections at Loraine are carried out in such a way that different sections of rope are inspected every month. The ropes are inspected and measured at every 15 drum turns, but the starting point of the inspection is adjusted every month. The points at which the measurements were taken closest to the front end and closest to the back end therefore varied from month to month, and were not the sections at the ends of the ropes. Nevertheless, the measured values were assumed to be representative of the ends of the ropes. The values at the middle of the rope (midshaft) were obtained by interpolating the values measured on either side of the midshaft section.

The rope diameters for the front, middle and back end sections of both ropes are shown in Fig. 1. The thicker line is for the underlay rope. The spin was let out of the underlay rope during month 16, which did not result in any change in rope diameter. Figure 1 shows that the rope diameters already differed from the front to the back after the ropes were installed (month 0). These diameter changes are caused by tensile loading of the rope; the higher the load, the smaller the diameter. The figure also shows that further reductions in rope diameter occurred with time, with the greater diameter reduction towards the back end of the rope. The diameter reductions while in service are caused by plastic deformation of the outer rope wires. The plastic deformation of a drum winder rope is greater towards the back end of the rope.

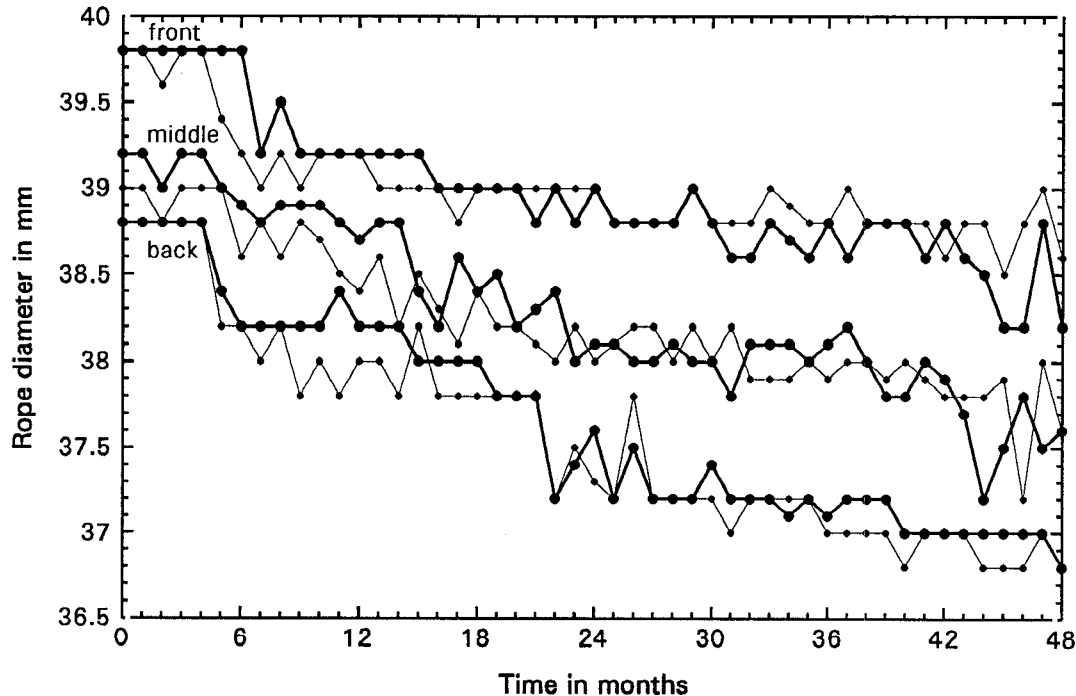

Figure 1: Rope diameters measured from the time of rope installation.

The rope laylengths obtained for the front, middle and back end sections of the ropes are shown in Figs 2 and 3 for the overlay and underlay ropes respectively.

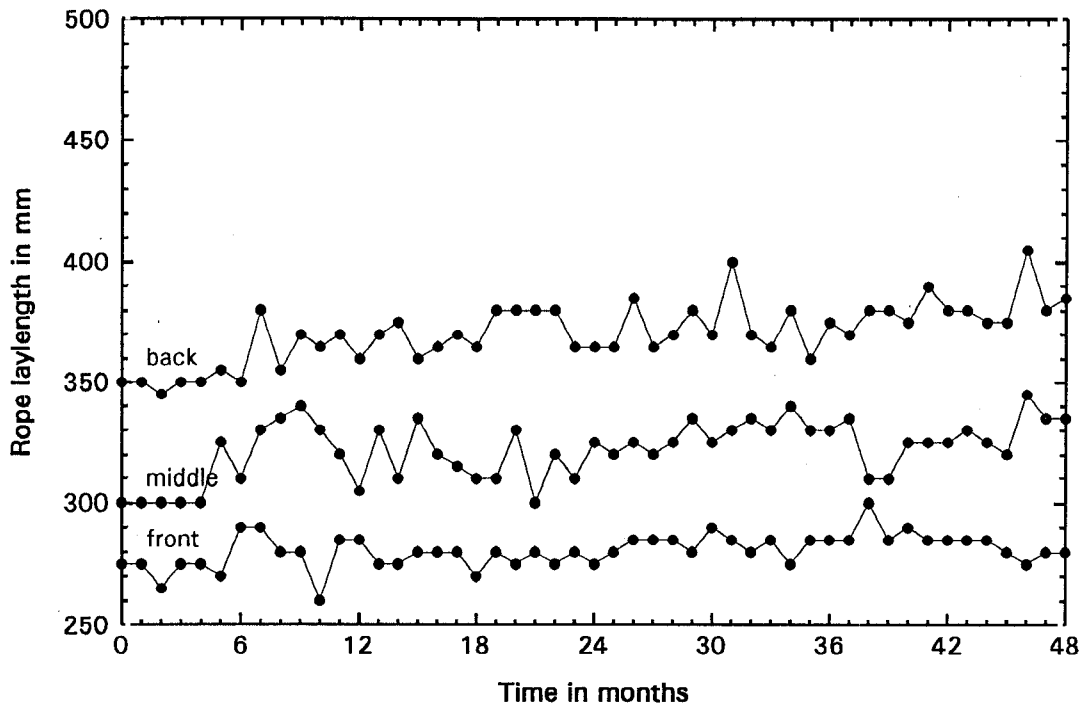

Figure 2: Laylengths measured on the overlay rope from the time of rope installation.

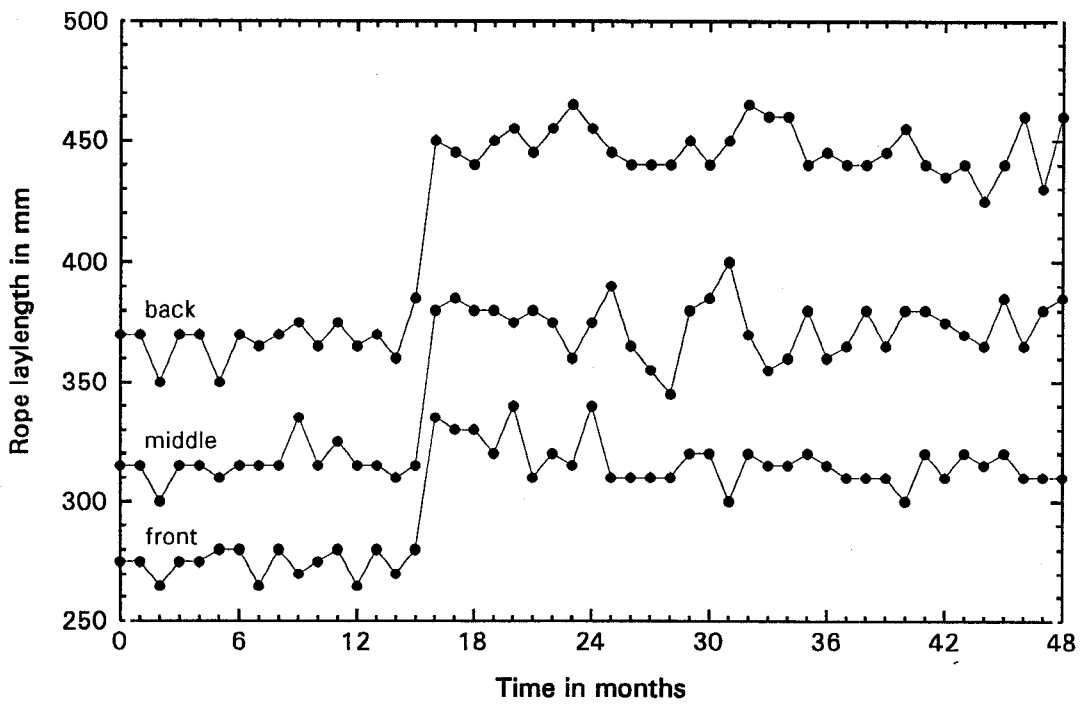

Figure 3: Laylengths measured on the underlay rope from the time of rope installation.

As expected, the rope laylength at the back ends of the rope are longer and the front end laylengths are shorter than the laylengths at midshaft. The middle of the rope should have laylengths resembling the as-manufactured value. Figure 2 shows that the laylengths for the back end and middle of the overlay rope increased gradually over the four year period. The values at the end of the four year period are close to the values with which the underlay rope started.

When the spin was let out of the underlay rope, the front end of the rope carried no load and returned to a state of zero torque. The front end of the rope therefore had to return to the as-manufactured state. This is shown in Fig. 3 where the front end laylength of the underlay rope, after spin was let out, was the same as the middle of the rope before spin was let out.

When the spin was let out of the underlay rope, the laylength at the back end increased to approximately 450 mm. If the as-manufactured laylength is assumed to have been 320 mm, the back end laylength was around 15% greater than the as-manufacture value before spin was let out, and 40% greater than the as-manufactured value after spin was let out.

2.4 PHYSICAL APPEARANCE OF THE ROPES

Images of the front, middle and back end sections of the underlay rope are shown in Fig. 4 together with an image of the middle section of the overlay rope. The extensive plastic deformation of the back end rope section is very noticeable. The ropes had to have done a fair amount of "work" to reach the appearance as shown.

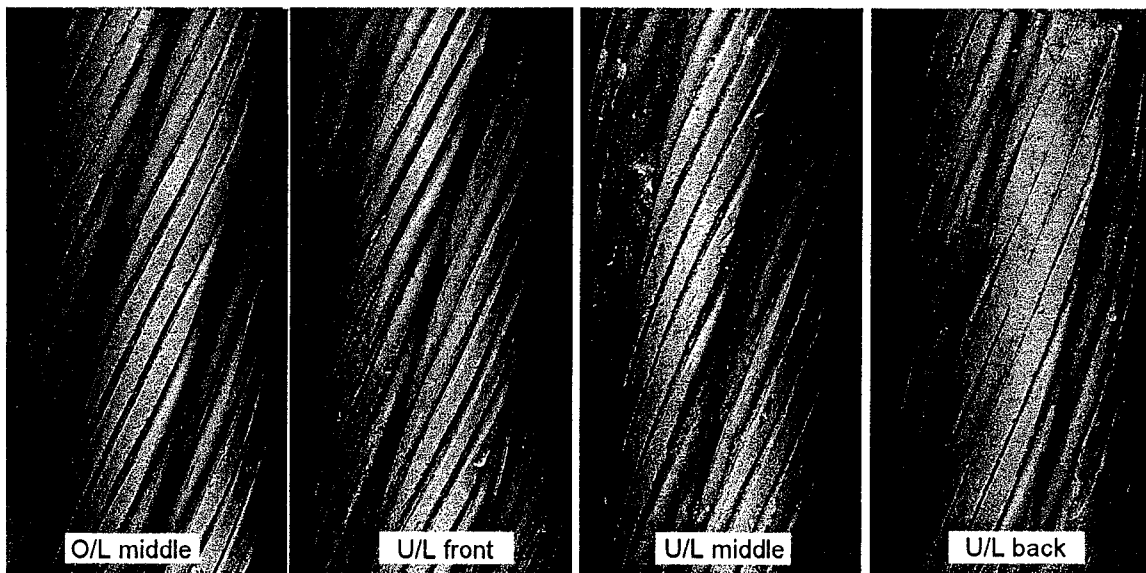

Figure 4: Physical appearance of the Loraine ropes.

2.5 OTHER OBSERVATIONS

When rope front ends are cut, the ropes have to be detached from the conveyances at bank level. Rope sections between the headsheaves and the bank will then return to a state of zero torque. At this winder the headsheaves are 40 m above the bank. When the front ends were cut in May 1997, the underlay rope lost 3 turns and the overlay rope 10 turns. The number of rope turns at midshaft level were also counted during skip loading. On both ropes 6 turns were counted. These observations for the overlay rope are assumed to be representative of the underlay rope before it lost the spin.

3. CALCULATION OF ROPE BEHAVIOUR

3.1 TORQUE-TENSION-TWIST CHARACTERISTICS

The torque-tension-twist characteristics of the Loraine ropes were obtained by tests carried out on a section of the spare rope of the winder. The tests were performed in the rope torque-tension testing facility of the CSIR at Cottesloe. The gauge length of the rope section used for the tests was 2 670 mm at a tensile load of 30 kN.

The rope torque was measured as a function of tensile load with different amounts of rotation applied at one end of the rope. Positive end rotation was in the direction of the rope lay, i.e. the rope was laid up. Negative end rotation unlaid the rope.

Before the actual tests started, the rope was cycled 50 times between 30 kN and 280 kN at zero end rotation. After that, the order of the tests were: 0° end rotation; +180°; +360°; +540°; 0°; -180°; -360°; -540°; -720°; -720° (again); -900°; -1 080°; -1 260°. The rope was returned to zero end rotation between each of the tests, but the minimum rope load was maintained at approximately 30 kN. At the start of each test, the rope load was cycled five times from 30 kN to 280 kN. The rope torque was measured during the sixth load cycle for both increasing and decreasing loads.

The rope laylength was measured manually at each end rotation with 30 kN tensile load applied.

The rope twist (in °/m) was obtained by dividing the rope end rotation by the specimen gauge length of 2,670 m.

3.1.1 Torque-tension-twist relationship

The torque-tension-twist relationship measured on the Loraine rope sample is shown in Fig. 5. The rope twist applied (in °/m) is per metre of rope length at 30 kN. Zero twist applied is the as-manufactured or natural condition. At 0°/m and -720°/m the tests were done twice.

The torque generated by the rope increased as the tension was increased. For a given tensile load, the torque generated by a triangular strand rope increases as the rope is laid up (positive twist), and decreases as it is unlaid. The slopes of the lines in Fig. 5 becomes steeper as the rope is laid up. For each of the rope twist conditions, the torque curve shows higher torque during the decreasing load cycle. This hysteresis increased as the rope was laid up, and is most probably a result of increased internal friction in the rope.

Although the torque-tension lines shown in Fig. 5 are not entirely linear, the following (linear) equation approximates the measured values reasonably well for positive torque:

$$T = aF + bFR + cR \quad (1)$$

where	T	=	rope torque in Nm	$a = 4,6 \times 10^{-3}$	Nm/m
	F	=	rope tension in N	$b = 3,2 \times 10^{-6}$	Nm/N/(°/m)
	R	=	rope twist in deg/m	$c = 1,1$	Nm/(°/m)

The approximation of the torque-tension behaviour is shown in Fig. 6.

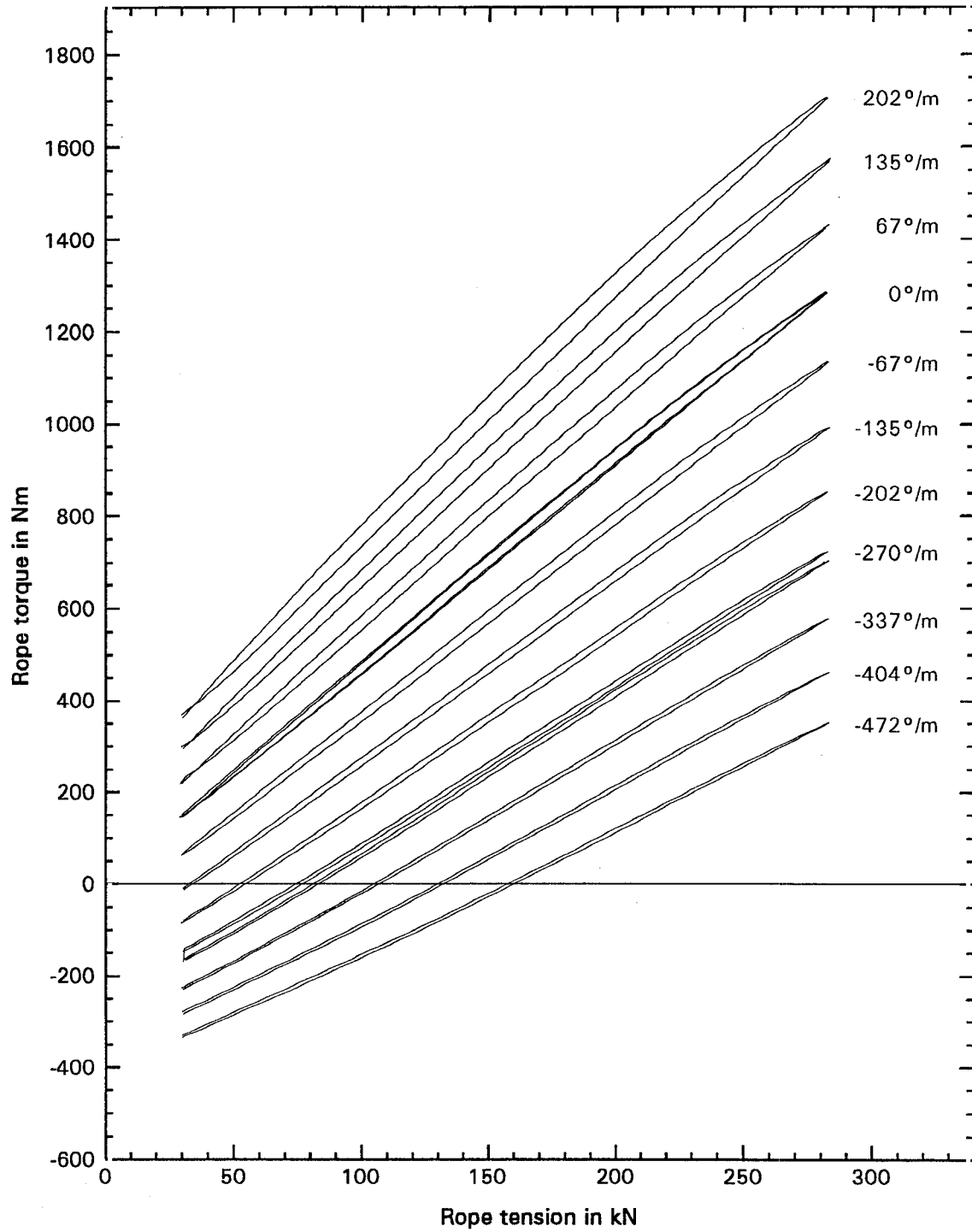

Figure 5: Torque generated by the Loraine rope sample as a function of rope tension for different degrees of twist.

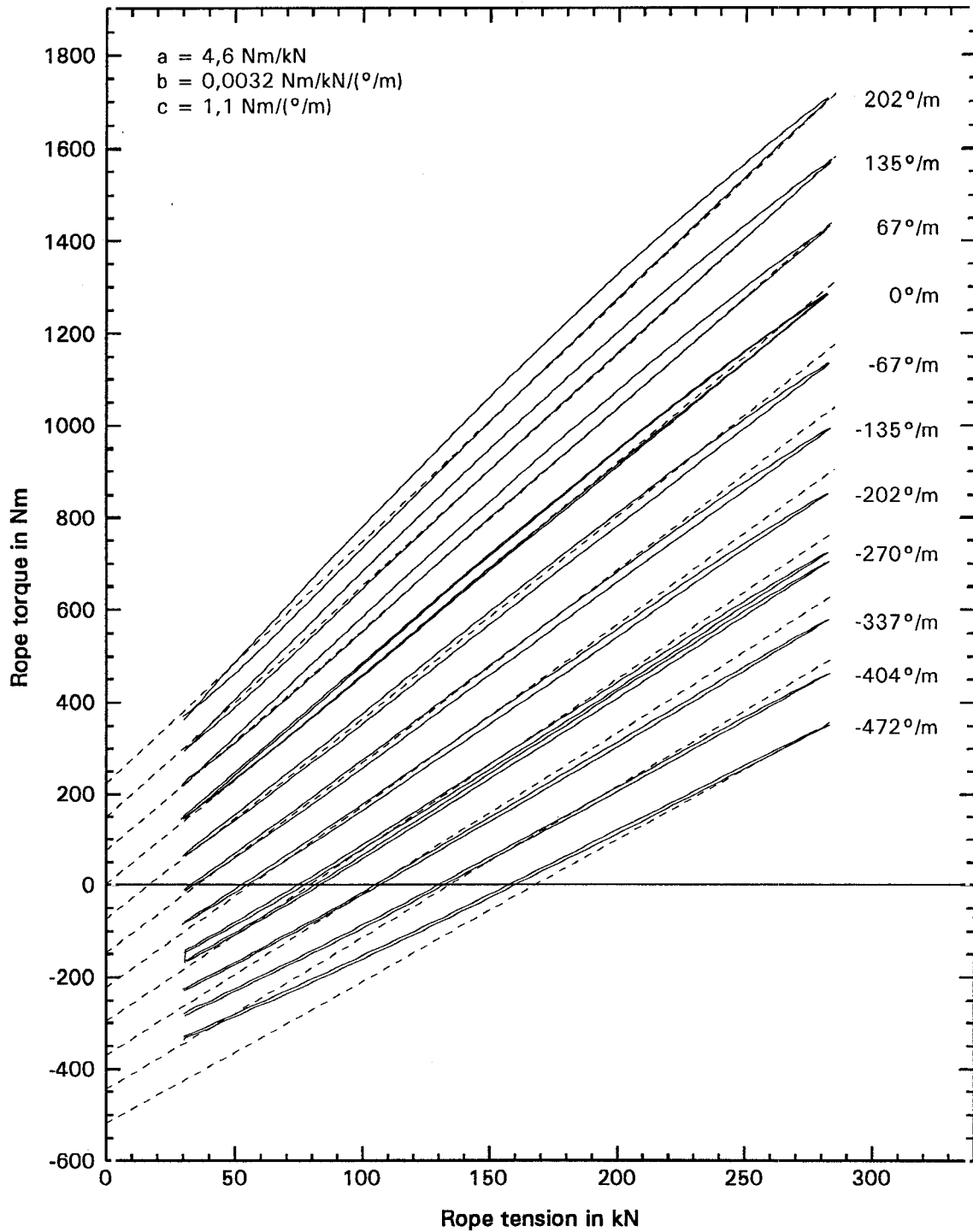

Figure 6: Linear approximation of the torque-tension-twist characteristics of the Loraine rope sample.

3.1.2 Twist-elongation-laylength relationship

When the rope specimen was loaded to 30 kN, and with no end rotation applied, the laylength was measured as 319 mm. This laylength will be referred to as the "natural" or as-manufactured laylength.

If it is further assumed that the centre of a strand is at $\frac{2}{3}$ of the rope radius, the length of the strand in one laylength can be calculated. In one laylength, the strands of the rope make one full rotation, i.e. 360° per laylength or $1\ 129^\circ/\text{m}$ length of rope in this case. Therefore, if the rope is unlaidd by $1\ 129^\circ$ per metre of its original length, the strands will be straight, and the rope will have elongated to the length of the strands. For the derivations in this section, the elongation from the unlaying of the strands themselves was ignored. (Strand diameters are smaller than the rope diameter. Strand unlaying will therefore have much less an effect on rope elongation than rope unlaying.)

The following equation for the elongation of the rope, as a function of rope twist was derived:

$$\Delta L = \sqrt{1 + \left[\frac{2 \pi d}{3 \text{ lay}l_0} \right]^2 \left[1 - \left[1 + \frac{\theta \text{ lay}l_0}{360^\circ} \right]^2 \right]} - 1 \quad (2)$$

with ΔL = rope elongation in m/m
 $\text{lay}l_0$ = natural laylength of the rope (m)
 d = rope diameter (m)
 θ = rope twist in $^\circ/\text{m}$ from the natural condition, $\text{lay}l_0$
 (positive if in the direction of the lay, i.e. laying up the rope)
 (negative for unlaying the rope)

Example: If this 39 mm rope, with a 319 mm natural laylength is unlaidd by $90^\circ/\text{m}$, $\theta = -90^\circ/\text{m}$, and the elongation of the rope will be 5 mm per metre original rope length. In comparison, the rope elongation if tensile loaded from 30 kN to 280 kN will be of the order of 3,5 mm.

An equation was also derived for calculation of the rope laylength when it is twisted by a given amount from its natural condition:

$$\text{lay}l_\theta = \frac{\sqrt{1 - \left[\frac{2 \pi d}{3 \text{ lay}l_0} \right]^2 \left[\left[1 + \frac{\theta \text{ lay}l_0}{360^\circ} \right]^2 - 1 \right]}}{\frac{1}{\text{lay}l_0} + \frac{\theta}{360^\circ}} \quad (3)$$

with $\text{lay}l_\theta$ = rope laylength (in metres) as a function of rope twist, θ
 $\text{lay}l_0$ = natural laylength of the rope (m)
 d = rope diameter (m)
 θ = rope twist in $^\circ/\text{m}$ from $\text{lay}l_0$

Calculated rope laylengths at different degrees of twist are compared with measured laylengths in Fig. 7. The solid line represents the calculated values, and the dots the measured values.

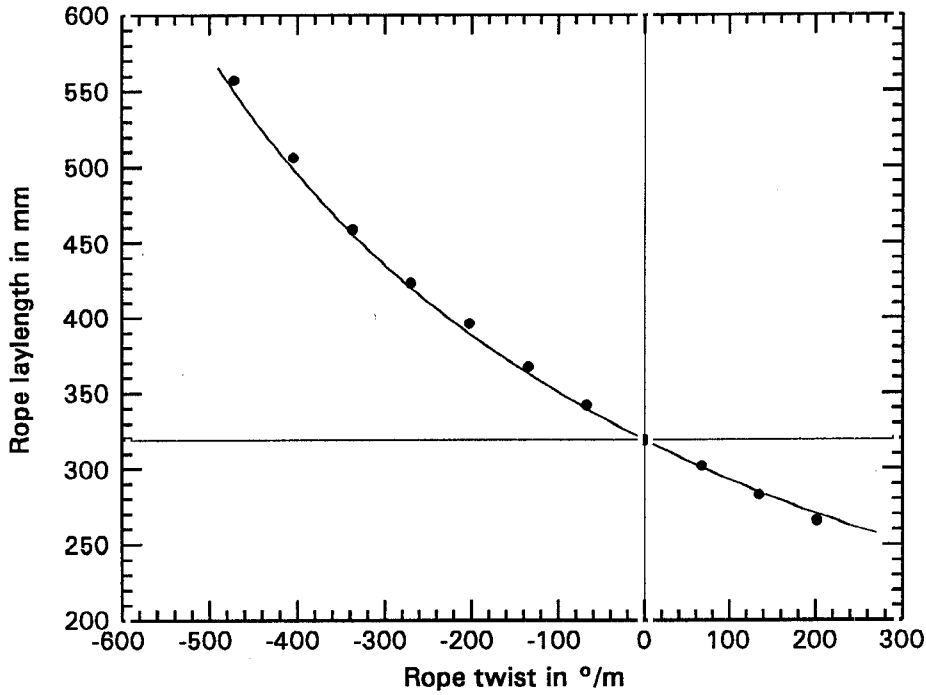

Figure 7: Measured and calculated rope laylengths as a function of rope twist from a laylength of 319 mm.

Equation 3 can also be written so that the twist required to give a certain laylength can be calculated:

$$\theta = \frac{360^\circ}{layl_0} \left(\sqrt{\frac{layl_0^2 + \left[\frac{2}{3} \pi d\right]^2}{layl_\theta^2 + \left[\frac{2}{3} \pi d\right]^2}} - 1 \right) \quad (4)$$

with θ = rope twist in degrees per metre length of rope at $layl_\theta$
 $layl_0$ = natural laylength of the rope (m)
 $layl_\theta$ = rope laylength (m)
 d = rope diameter (m)

For a given in-service laylength of a section of rope, the twist (from the as-manufactured condition) that the section of rope experienced to reach the given laylength can be calculated with Eqn 4. Equation 4 can also be written to take an infinite original laylength ($layl_0$) into account:

$$\theta = 360^\circ \left(\sqrt{\frac{1 + \left[\frac{2 \pi d}{3 layl_0}\right]^2}{layl_\theta^2 + \left[\frac{2}{3} \pi d\right]^2}} - \frac{1}{layl_0} \right) \quad (5)$$

Example: For the natural laylength of 319 mm, 1 129°/m (at that laylength) is required to "straighten" the rope completely. To obtain a 319 mm laylength from a straight strand rope ($layl_0 = \infty$), only 1 093°/m (of the straight rope) is required. The difference comes from the 3,2% increase in rope length when the rope is straightened from a 319 mm laylength.

3.2 BEHAVIOUR OF A VERTICALLY SUSPENDED ROPE

3.2.1 Derivation of equations

The directions for positive values of the variables of Eqn 1 (tension F , torque T and twist R) are shown in Fig. 8 together with a coordinate, x , along the length of the rope. These values have to be applied at the "free" end of the rope to maintain a given rope condition.

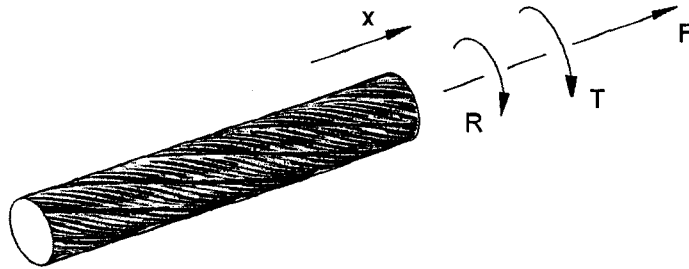

Figure 8: Directions for positive tension (F), torque (T) and twist (R).

For a given tension, the torque and twist are related as given by Eqn 1. The torque between two fixed ends of a rope (points where rotation is restricted) has to be constant. The tension in a horizontally loaded rope is constant, while the tension in a vertically suspended rope changes along the length of the rope. If the tension in a rope is constant, the twist has to be constant, but if the tension varies along the length of a rope, the twist has to vary to maintain the constant torque.

Rope twist and rope rotations always go together. Zero twist and rotation is defined as the (natural) state of a rope when it is not loaded and the ends are free.

If the twist in a length of rope is described as a function of the coordinate along the length of the rope, then the rotation of the rope at one point relative to another point can be calculated by integrating the twist along that length of rope:

$$rot_{2,1} = \int_{x_1}^{x_2} R(x) dx \quad (6)$$

where $R(x)$ = twist as a function of x along the length of the rope
 $rot_{2,1}$ = rotation at x_2 relative to the rotation at x_1 in degrees

A positive rotation at x_2 relative to x_1 will be in the same direction as positive twist.

A vertically suspended rope will have a tension that changes along the length of the rope, with the back end (top) having a higher tension than the front end (bottom). If the ends of the rope

are prevented from rotating, the back end of the rope (with the higher tension) will tend to generate a greater torque than the front end. However, the torque has to be constant along the length of the rope. For torque equilibrium to be established, the back end of the rope will unlay to reduce its torque, and the laylength will become longer. The front end will have to lay up to increase its torque and the laylength will become shorter. The net result is that the "middle" part of the rope will rotate in order to equalise the torque along the length of the rope. The rotation will be in the direction of the lay if observed from the front (skip) end of the rope.

Let x be the distance measured from the skip along the length of a vertically suspended rope of length L_s . Let $F(x)$ and $R(x)$ be functions that describe the rope tension and rope twist along the rope. Equation 1 can then be written as:

$$T = a F(x) + b R(x) F(x) + c R(x) \quad (7)$$

where $T =$ a constant torque (Nm)
 $R(x) =$ a function in x describing the twist in the rope ($^{\circ}/m$). Zero twist being the natural or as-manufactured condition.
 $F(x) = mx + s$
 with $s =$ the weight attached at the front end of the rope (N)
 $m =$ the weight of the rope per unit length (N/m)

Rewriting Eqn 7 for R gives:

$$R(x) = \frac{T - a(mx + s)}{c + b(mx + s)} \quad (8)$$

If the rope torque, T , in Eqn 7 is known, the rope twist, R , can be calculated.

The relative rotation ($rot_{2,1}$) between any two points on the rope (x_1 and x_2) is obtained by substituting Eqn 8 into Eqn 6. Evaluating the integral gives:

$$rot_{2,1} = \left[\frac{Tb + ac}{b^2 m} \right] \ln \left[\frac{b(mx_2 + s) + c}{b(mx_1 + s) + c} \right] - \frac{a}{b} (x_2 - x_1) \quad (9)$$

Equation 9 can be rewritten for torque, T , as:

$$T = \frac{b m rot_{2,1} + a m (x_2 - x_1)}{\ln \left[\frac{b(mx_2 + s) + c}{b(mx_1 + s) + c} \right]} - \frac{ac}{b} \quad (10)$$

If the relative rotation between two points on the rope (x_1 and x_2) is known, the torque, T , generated by the rope can be calculated with Eqn 10. The variation of the twist, $R(x)$, with x , can then be calculated with Eqn 8.

When a new rope is installed on a winder, the front end of the rope is connected to the skip before the rope is payed out. The rotation (rot) at the back end relative to the front end for this situation is considered to be equal to zero. The torque, twist and rotation for that condition (loaded and unloaded) can be calculated by setting $x_1 = 0$, $x_2 = L_s$, and $rot_{2,1} = 0$ in Eqn 10 and using the appropriate value for s (empty or full skip).

When spin is "let out" at the front end of a rope (e.g. when the front end is cut), the back end of the rope rotates (negatively) relative to the front end. For such a situation the rot in Eqn 10 is set equal to the spin that was "let out" (a negative number = 360° times the front end turns).

3.2.2 An example calculation

The torque-tension-twist behaviour of a rope is calculated in this section for the winder parameters of the Loraine winder and the rope torque-tension-twist constants as given with Eqn 1.

$$\begin{aligned} L_s &= 1\,825 \text{ m} \\ m &= 64,4 \text{ N/m} \\ s &= 37,3 \text{ kN for an empty skip} \\ &= 101,0 \text{ kN for a full skip} \end{aligned}$$

The rope torque for a fully payed out rope, and for zero relative rotation between rope ends, was calculated with Eqn 10 for an empty skip T_e and a full skip T_f :

$$\begin{aligned} T_e &= 430 \text{ Nm} \\ T_f &= 724 \text{ Nm} \end{aligned}$$

Figure 9 shows the variation of the twist, R , in the rope (as given by Eqn 8) as a function of x (distance from the skip) for both the empty and full skip conditions.

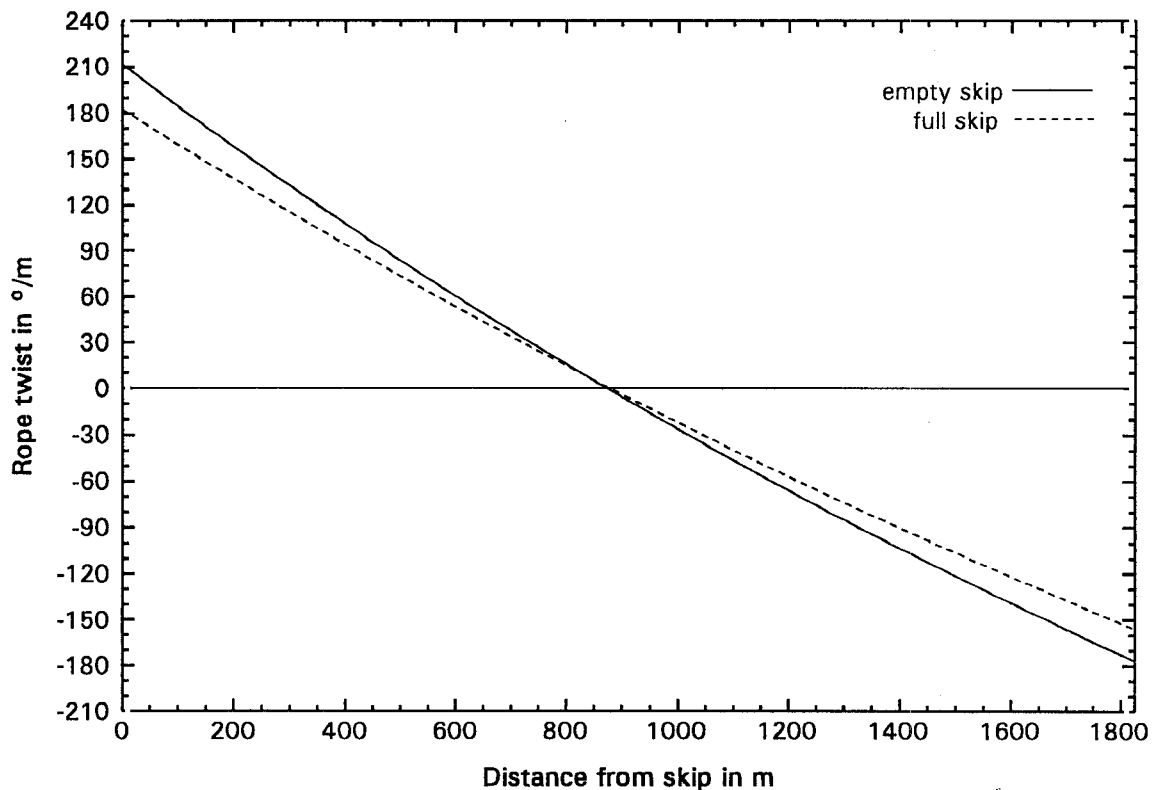

Figure 9: Rope twist as a function of position along the rope.

Figure 9 shows that the rope twist for the empty skip is greater at the rope ends than for the full skip condition. The rope laylengths associated with the rope twist at the rope ends were calculated

with Eqn 3. For the empty skip condition, the back end twist of $-177^\circ/\text{m}$ gave a laylength of 382 mm, and the front end twist of $212^\circ/\text{m}$ gave a laylength of 265 mm. These values represent an increase of 20% at the back end, and a decrease of 17% at the front end, compared to the natural laylength of 319 mm.

The rotation of the rope relative to the skip end (in the number of full rope turns) is shown in Fig. 10 as a function of x for both loading cases. The difference in rope rotation between the empty and full skip conditions will be the number of turns that the rope will make at midshaft when the skip is loaded.

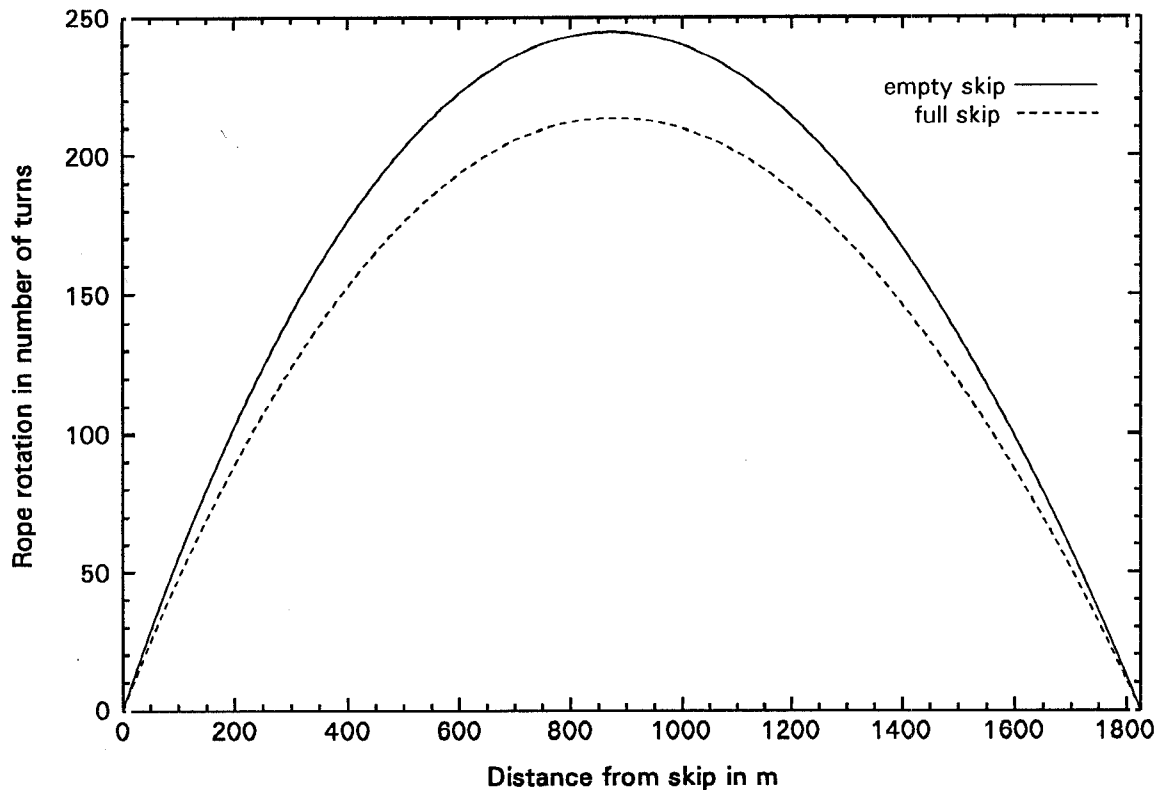

Figure 10: Rotation of the rope as a function of position along the rope.

3.3 LETTING OUT SPIN

When the rope is fully payed out and the front end released, the rope will rotate (untwist) to reduce the rope torque to zero. Setting both the torque, T , and the weight at the front end of the rope, s , equal to zero in Eqn 9, gives the rotation of the back end relative to the front end as $-367\,000^\circ$. This is also equal to the rope rotation that will be lost at the front end when the front end is released. Dividing the calculated rotations by 360° , gives the spin lost as 1 019 full rope turns at the front end.

With a free front end, the rope twist at the front end will be zero, and the laylength there will return to the as-manufactured value of 319 mm. The rope twist at the back end (with zero load at the front end) was calculated with Eqn 8 as $-366^\circ/\text{m}$. The laylength associated with this twist was calculated with Eqn 3 as 481 mm.

When the (empty) skip is attached again to the free end of the rope, the rope will generate a torque again. The rope torque for the empty skip attached, after the rope has lost spin, was calculated with Eqn 10 by using the value of $rot_{2,1}$ for the spin lost. This gave 149 Nm (as opposed to the 430 Nm with an empty skip before all the spin was lost).

The twist at any point along the length of the rope, for the empty skip attached was calculated by substituting the calculated torque and the appropriate value for s into Eqn 8. This gave rope twist (and laylength values) of $-353^\circ/\text{m}$ (472 mm) and $-19^\circ/\text{m}$ (325 mm) for the back end and front end respectively.

It is of interest that the front end unlayed and the back end laid up when the skip was attached to the front end of the freely suspended rope. Figure 6 shows that the torque line at $0^\circ/\text{m}$ is steeper than for twist of the order of $-350^\circ/\text{m}$. The front end therefore actually produced more torque than the back end when the skip was attached, and had to unlay for equilibrium to be established.

4. COMPARISON WITH THE ACTUAL ROPE BEHAVIOUR

Figures 2 and 3 (p. 6) show that the measurements of the in-service laylengths on the overlay rope were slightly more erratic than those of the underlay rope. As the interest of this report lies with the underlay rope (the one that has lost the spin), the laylengths of the underlay rope will be used for the comparisons in this section.

Rope laylengths are normally measured with an empty skip attached to the end of a rope. The calculations of the previous section have also shown that the twist of a rope is greater for the empty skip condition than for a loaded skip. This section will therefore concentrate on the empty skip condition.

4.1 INITIAL COMPARISON

Table 2 compares the laylengths measured for the underlay rope of the Loraine winder with the values calculated with the torque-tension-twist constants given with Eqn 1. The as-manufactured laylength was assumed to be 319 mm.

Table 2: Laylength comparisons (empty skip attached).

	Laylengths as installed		Laylengths after letting out spin	
	Actual	Calculated	Actual	Calculated
Front end	275 mm (-14%)	265 mm (-17%)	315 mm (-1%)	325 mm (+2%)
Back end	370 mm (+16%)	382 mm (+20%)	450 mm (+41%)	472 mm (+48%)
Rope torque		430 Nm		149 Nm

Although the laylength measurements at the mine might not have been very accurate, the laylength changes calculated with the constants of Eqn 1 gave values that were greater than the actual laylength changes. Furthermore: Figure 10 shows a calculated midshaft difference of approximately 30 rope turns between the empty and full skip conditions, as opposed to the six turns measured on the mine (see section 2.5, p. 7).

The indications are therefore that the initial general approximation of the torque-tension-twist characteristics (see Fig. 6 and Eqn 1) under-estimated the torsional stiffness of the rope, and over-estimated the combined torque-force constant.

The theoretical predictions can be improved by either:

- Establishing a different (non-linear) model to describe the torque-tension-twist characteristics, or by
- adjusting the constants of the (linear) model described in the previous section to approximate the behaviour of the rope better in the areas of the expected rope behaviour, instead of for the total extent of the torque-tension-twist tests that were performed.

It was possible to adjust the constants of the linear model to approximate the torque-tension-twist characteristics determined during the laboratory tests more accurately in the regions of the observed and expected rope behaviour. The next section describes these modified torque-tension-twist characteristics.

4.2 ADJUSTED ROPE CONSTANTS

The adjusted rope torque-tension-twist constants were determined through inspection, and are:

$$T = aF + bFR + cR \quad (11)$$

where	T	=	rope torque in Nm	$a = 4,6 \times 10^{-3}$	Nm/m
	F	=	rope tension in N	$b = 2,6 \times 10^{-6}$	Nm/N/(°/m)
	R	=	rope twist in deg/m	$c = 1,35$	Nm/(°/m)

Constant b was decreased, constant c was increased, while the value of constant a was maintained. The approximation of the torque-tension curves are shown in Fig. 11.

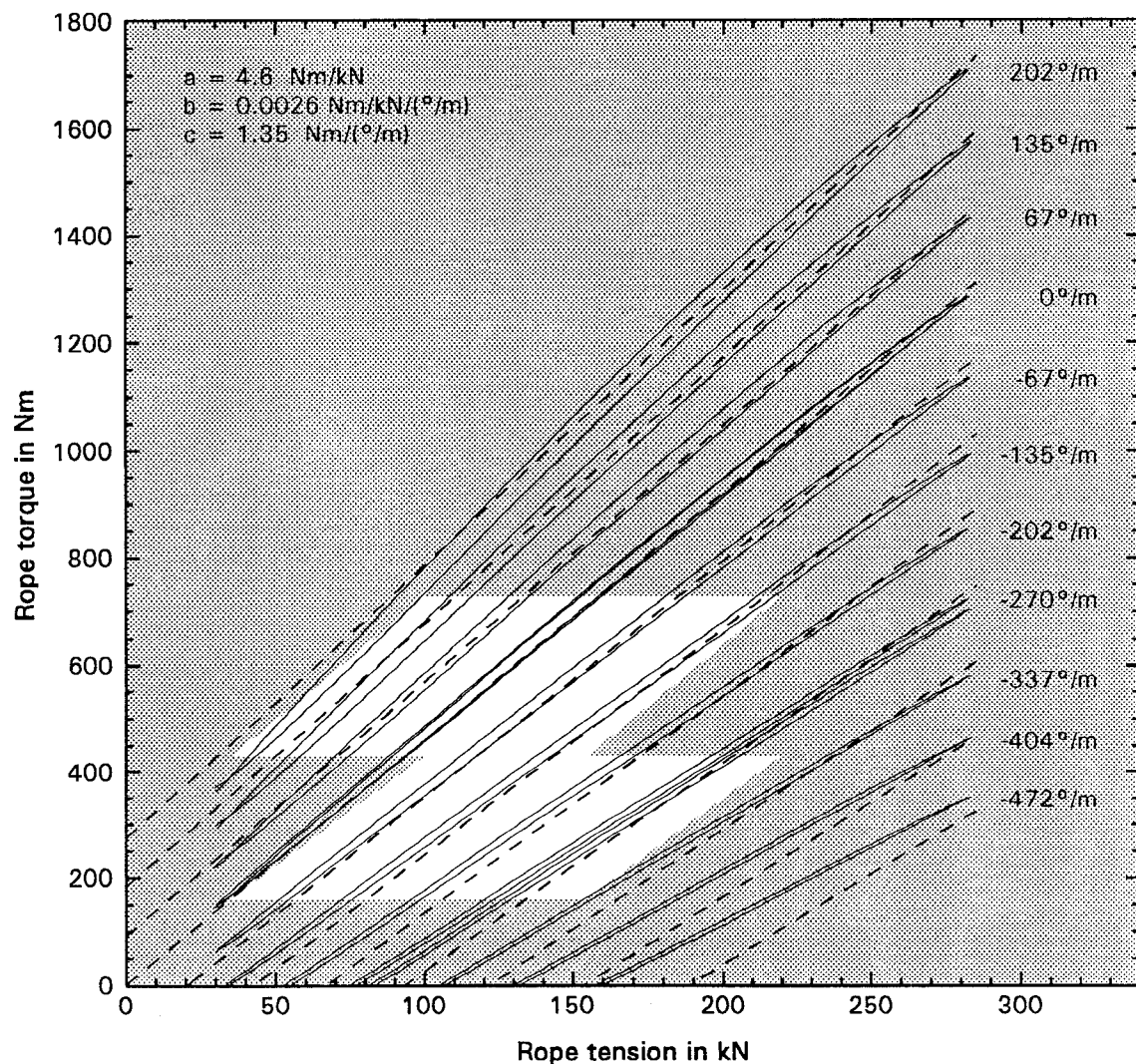

Figure 11: Linear approximation of the torque-tension-twist behaviour of the rope.

The "window" in Fig. 11 shows the regions of the Loraine experience. The upper parallelogram is for the rope before it lost the spin, and the bottom parallelogram is for the rope after it has lost spin. The lower torque boundaries are for an empty skip and the upper boundaries for a loaded skip.

Figure 11 further shows that the approximation is quite accurate for higher rope loads as long as the rope twist remains within the $+200^{\circ}/\text{m}$ and $-350^{\circ}/\text{m}$ limits. The linear rope behaviour model, based on Eqn 11, will therefore be appropriate for predicting the behaviour of the rope at the increased rope loads of deeper shafts.

4.3 RE-CALCULATION OF ROPE BEHAVIOUR

The calculation of the rope torque-tension-twist behaviour was done with equations derived in section 3, and the rope constants of Eqn 11.

4.3.1 As installed

The "as installed" condition is for before the spin was let out of the rope. Figure 12 shows the variation of the twist in the rope as a function of distance from the skip for both the empty and full skip conditions. Figure 13 shows the rotation of the rope relative to the skip end in the number of full rope turns. The values obtained from the calculations are given in Table 3.

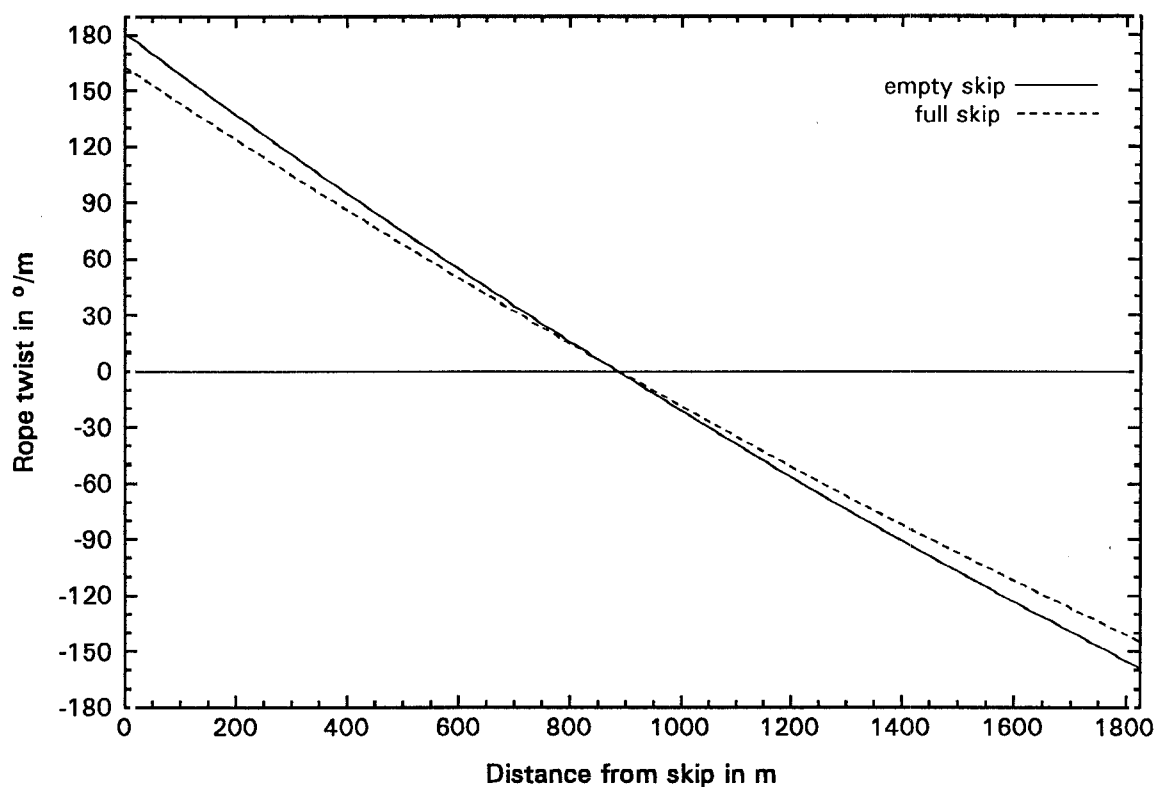

Figure 12: Rope twist as a function of position along the rope (adjusted rope constants).

Table 3: Rope torque, twist and laylengths for the as installed condition.

Natural laylength = 319 mm	Empty skip: Torque = 433 Nm		Full skip: Torque = 727 Nm	
	Twist	Laylength	Twist	Laylength
Front end	181°/m	272 mm (-15%)	163°/m	276 mm (-13%)
Middle	-5°/m	320 mm (+0%)	-4°/m	320 mm (+0%)
Back end	-159°/m	375 mm (+17%)	-145°/m	369 mm (+16%)

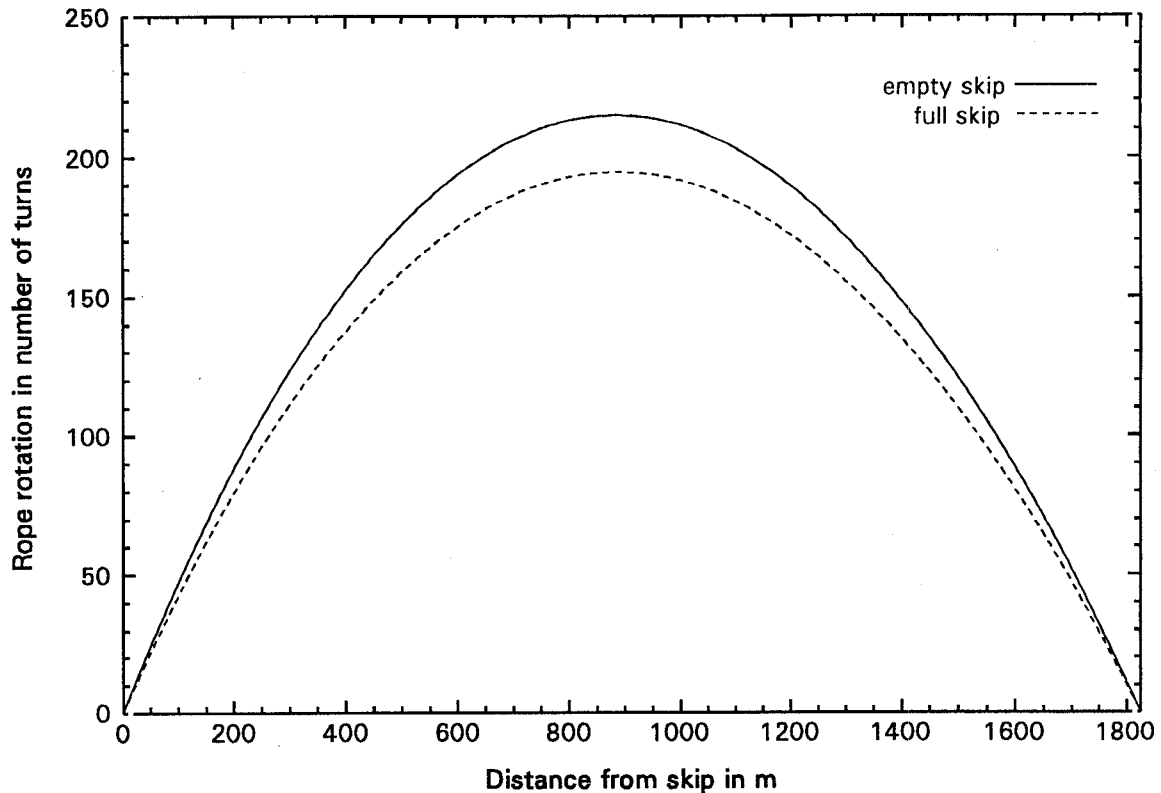

Figure 13: Rotation of the rope relative to the skip end of the rope (adjusted rope constants).

The difference between the rotations at midshaft for the empty and full skips, for the as installed condition, is 20 full turns as shown in Fig. 13. Detaching the rope at bank level (40 m below the headgear sheave) for cutting front ends should give 20 rope turns (spin out).

4.3.2 After letting out spin

Detaching the front end of the fully payed out rope will result in that end of the rope losing 884 full rope turns. The rope twist and laylengths for empty and full skip conditions after the rope lost the calculated amount of spin are given in Table 4. Figure 14 shows the variation of the twist in the rope, and Fig. 15 shows the rotation of the rope relative to the skip end.

Table 4: Rope torque, twist and laylengths for after the rope front end lost 884 full turns.

Natural laylength = 319 mm	Empty skip: Torque = 155 Nm		Full skip: Torque = 420 Nm	
	Twist	Laylength	Twist	Laylength
Front end	-11°/m	322 mm (+1%)	-28°/m	328 mm (+3%)
Middle	-179°/m	383 mm (+20%)	-178°/m	382 mm (+20%)
Back end	-318°/m	451 mm (+41%)	-305°/m	444 mm (+39%)

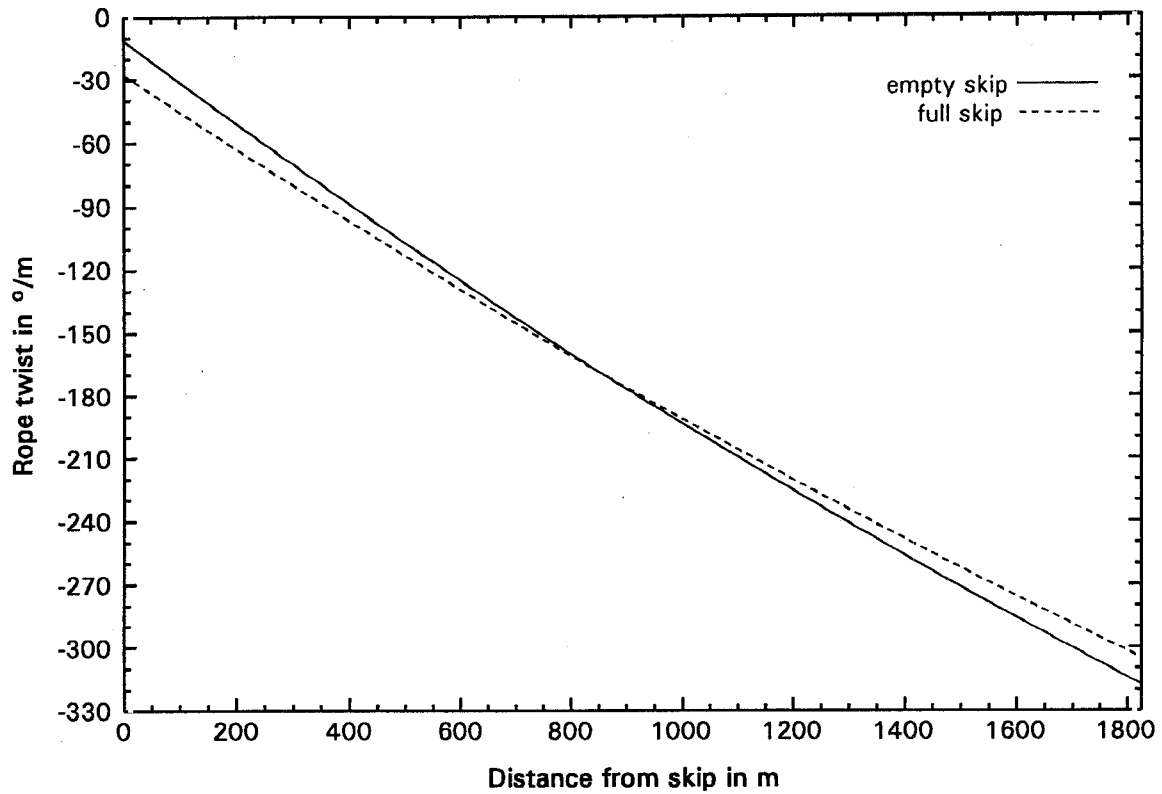

Figure 14: Rope twist as a function of position along the rope after the rope lost 884 full turns (adjusted rope constants).

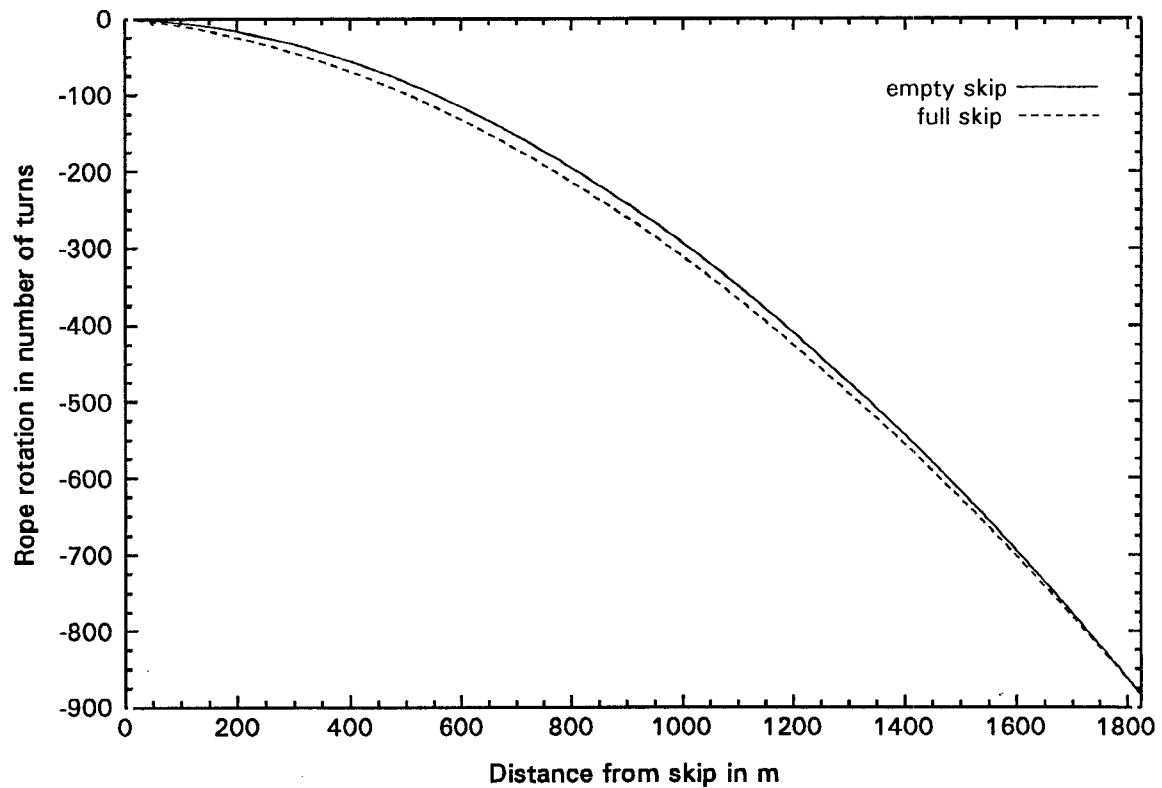

Figure 15: Rotation of the rope relative to the skip end of the rope after the rope lost 884 full turns (adjusted rope constants).

The difference between the rotations at midshaft for the empty and full skips, after the rope lost spin, is 18 full turns as shown in Fig. 15. This is for all practical purposes the same as the 20 turns calculated for the rope before it lost the spin. Detaching the rope from the skip at bank level will now only give $1\frac{1}{4}$ rope turns (laying up!) as opposed to the 20 turns (spin out) for the as installed condition.

It should also be noted that the operating rope torque decreased substantially as a result of letting the spin out of the rope.

4.4 COMPARISONS BASED ON THE ADJUSTED ROPE CONSTANTS

Table 5 compares the laylengths measured for the underlay rope of the Loraine winder with the values calculated with the adjusted torque-tension-twist constants given with Eqn 11. The as-manufactured laylength was again assumed to be 319 mm.

Table 5: Laylength comparisons with the adjusted rope constants (empty skip attached).

Natural laylength = 319 mm	Laylengths as installed		Laylengths after letting out spin	
	Actual	Calculated	Actual	Calculated
Front end	275 mm (-14%)	272 mm (-15%)	315 mm (-1%)	322 mm (+1%)
Middle	315 mm (-1%)	320 mm (+0%)	380 mm (+19%)	383 mm (+20%)
Back end	370 mm (+16%)	375 mm (+17%)	450 mm (+41%)	451 mm (+41%)
Rope torque	Empty skip = 433 Nm Full skip = 727 Nm		Empty skip = 155 Nm Full skip = 420 Nm	

The differences between the actual and the calculated values in Table 5 are within the measuring accuracy of the actual laylengths. The adjusted rope constants therefore describe the behaviour of the Loraine winder rope accurately.

The observations for the overlay rope was assumed to be representative of the underlay rope before it lost the spin (see section 2.5). The number of rope turns counted at midshaft during skip loading (6 turns on both ropes) are approximately one third of the calculated values. The reason for the difference could be torsional friction in the rope, or that the ropes became torsionally stiffer after extended use. The reason for the difference is not of importance in the context of this report. What is important is that by losing spin, the underlay rope did not lose its ability to change its rotational orientation during loading of the skip. This is substantiated both by the calculations and the actual observations. The ability of a triangular strand rope to change its rotational orientation during loading ensures that the surface deterioration of the rope is evenly distributed around the circumference of the rope.

As expected, the turns that will be lost at bank level during front end cuts are less for the rope that has lost spin compared to normal situation. Ten turns were observed on the overlay rope compared to 20 calculated. Three turns were observed on the underlay rope compared to (minus) $1\frac{1}{4}$ calculated. The differences are small in comparison with the more than 800 turns that the rope lost when the spin was let out. The important point again is that the observed behaviour is as expected and of the order of the calculated values.

In general, the calculated rope behaviour agrees quite well with the observed rope behaviour. The derived rope torque-tension-twist model is therefore acceptable.

5. PREDICTED DEEP SHAFT BEHAVIOUR

The prediction of the behaviour of triangular strand ropes in deep shafts is shown in this section. Shaft depths of 3 200 m and 4 000 m were selected. Currently it is not anticipated that single lift shafts of deeper than 4 000 m will be required by the mining industry.

The calculations were done by simply increasing the length of the suspended ropes of the Loraine winder. Only the empty skip condition was considered for the calculations in this section because it gives the greatest values of rope twist and laylength changes. The skip mass and rope mass per metre as given in Table 1 were therefore used. Although the new rope strength regulations will allow greater loads to be attached at the front end of the rope than in the Loraine winder case, it was assumed that the relatively light skip in operation at Loraine would be representative of the lower limits of skip masses.

5.1 ROPE TWIST AND LAYLENGTH LIMITS

The limits of laylength changes was postulated in section 1.3 as an 80% increase and a 20% decrease from the as-manufactured condition.

Assuming an as-manufactured laylength of 319 mm for the Loraine rope, the above limits translate into an increase in laylength to 574 mm, and a decrease in laylength to 255 mm. The corresponding rope twists from the as-manufactured condition associated with these laylengths are $-488^{\circ}/\text{m}$ and $+255^{\circ}/\text{m}$.

It is of interest to note that nothing (even in the current regulations) prevent the 39 mm diameter Loraine rope to be used at a depth of 2 500 m with the same skip mass and payload. At that depth the front end would have a laylength decrease of 19%, which is very close to the postulated 20% limit.

The torque-tension-twist model has twist limits of the order of $+200^{\circ}/\text{m}$ and $-350^{\circ}/\text{m}$. For the calculations in this section it will have to be assumed that the model behaves acceptably for greater degrees of twist.

5.2 A 3 200 m DEEP SHAFT

The rope torque, twist and laylengths for the Loraine rope in a 3 200 m deep shaft were calculated as before. The laylengths and percentage change in laylength were based on an as-manufactured laylength of 319 mm.

The back end of the rope showed a 30% increase in laylength, and the front end a 23% decrease in laylength. The back end increase in laylength is less than for the Loraine case after the rope lost spin, but the front end decrease in laylength could be unacceptable.

The laylength situation of the rope in a 3 200 m shaft can be improved by deliberately letting out spin in order to lengthen the front end laylength. For this shaft depth, letting out 800 turns was found to be the most appropriate.

Table 6 compares the rope torque, twist and laylengths for normal installation and after 800 turns were let out.

Table 6: Rope behaviour in a 3 200 m shaft. Twist and laylengths calculated for an empty skip attached at the rope front end.

Natural laylength = 319 mm	Normal installation		800 rope turns let out	
	Twist	Laylength	Twist	Laylength
Front end	+310°/m	245 mm (-23%)	+205°/m	267 mm (-16%)
Back end	-252°/m	416 mm (+30%)	-329°/m	457 mm (+43%)
Rope torque	Empty skip = 621 Nm Full skip = 916 Nm		Empty skip = 468 Nm Full skip = 748 Nm	

The rotation of the rope relative to the front end, after 800 rope turns were let out is shown in Fig. 16.

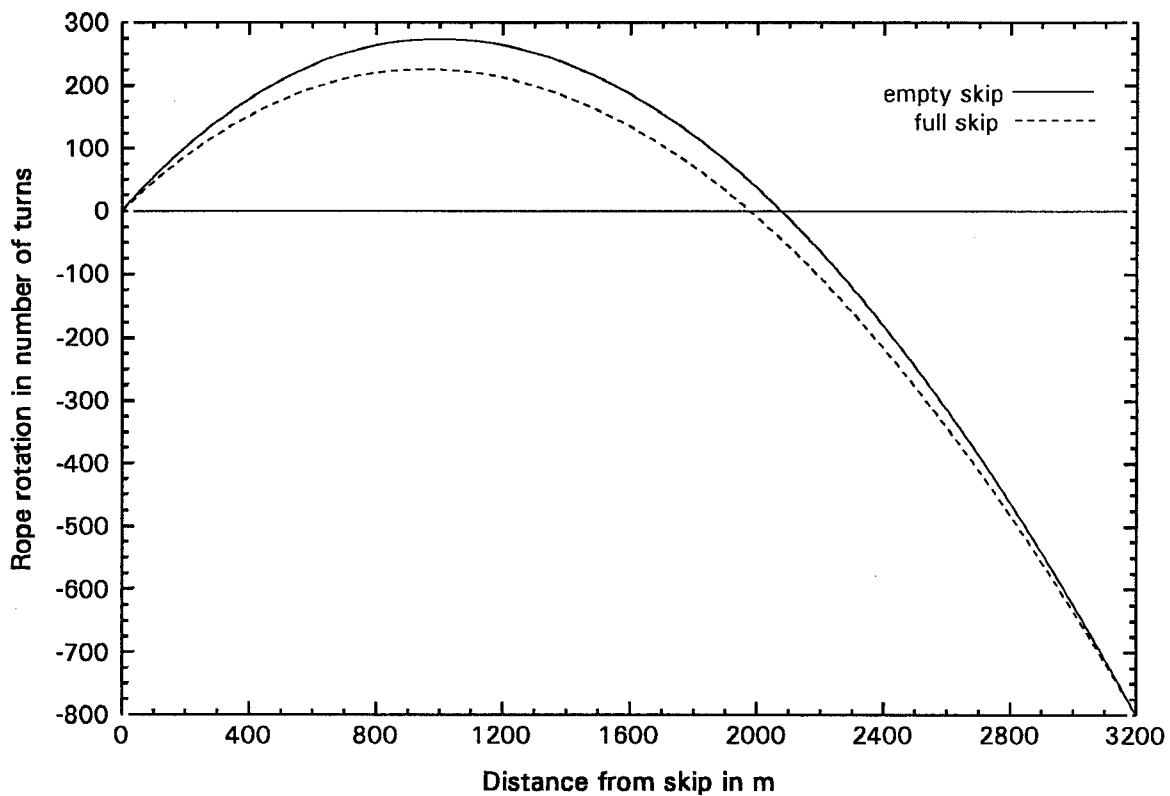

Figure 16: Rotation of the rope relative to the skip end; 3 200 m deep shaft, 800 rope turns let out.

Table 5 (p. 23) shows that the front end laylength of the Loraine winder underlay rope was at -14% before spin was let out, and the back end laylength at +41% after the spin was let out. Before the spin was let out, the rope torque was calculated as 727 Nm.

Except for the back end rope load that will be greater in a 3 200 m shaft than for the Loraine winder, the rope laylengths and rope torque will be nearly the same as that experienced at Loraine if 800 rope turns are deliberately let out. From this point of view, a 39 mm diameter triangular strand rope should perform acceptably in a 3 200 m deep shaft.

5.3 A 4 000 m DEEP SHAFT

The rope torque, twist and laylengths for the Loraine rope in a 4 000 m deep shaft for normal installation and after 1 100 rope turns were let out deliberately, are shown in Table 7.

Table 7: Rope behaviour in a 4 000 m shaft. Twist and laylengths calculated for an empty skip attached at the rope front end.

Natural laylength = 319 mm	Normal installation		1 100 rope turns let out	
	Twist	Laylength	Twist	Laylength
Front end	+383°/m	232 mm (-27%)	+263°/m	254 mm (-20%)
Back end	-298°/m	440 mm (+38%)	-380°/m	490 mm (+53%)
Rope torque	Empty skip = 727 Nm Full skip = 1 023 Nm		Empty skip = 552 Nm Full skip = 832 Nm	

For normal rope installation, the back end laylength is still not greater than the +41% experienced at Loraine. However, the front end laylength will decrease by 27%, which should give problems.

Letting out 1 100 rope turns will result in a back end laylength of +53%, a front end laylength of -20%, and a rope torque reduced to 830 Nm for a full skip. These values are greater than the Loraine experience of +41% and -14%.

The Loraine rope that lost the spin showed no detriment in rope performance. There is therefore no reason for the Loraine experience to constitute the limits of rope laylength increases. There is therefore a great possibility that these ropes could perform satisfactorily at shaft depths of 4 000 m.

5.4 LARGER ROPE DIAMETERS

A 48 mm triangular strand rope has a 23% greater diameter than the 39 mm diameter Loraine rope. For the same tensile grade, the rope strength and rope mass increase with the square of the diameter. For the same shaft depth and rope load factors (% of breaking strength), a 48 mm rope will be able to carry 51% more load at its front end than a 39 mm diameter rope.

The torque-tension-twist constants of a 48 mm diameter triangular strand rope were obtained from an earlier report,² and are:

$$\begin{aligned}
 a &= 5,4 \times 10^{-3} \text{ Nm/m} \\
 b &= 5 \times 10^{-6} \text{ Nm/N}/(^{\circ}/\text{m}) \\
 c &= 2,7 \text{ Nm}/(^{\circ}/\text{m})
 \end{aligned}$$

The empty skip weight and rope weight, equivalent to the Loraine experience, for a 48 mm rope will be 56,4 kN and 97,2 N respectively.

An as-manufactured laylength of 380 mm was assumed for the 48 mm rope (approximately eight rope diameters). The rope twist and laylengths for a 48 mm rope in a 1 825 m deep shaft were calculated for an empty skip attached at the rope front end, and for a normal installation (no rope

spin lost). The values for the 48 mm rope are compared to that of the 39 mm rope (Table 3, p. 20) in Table 8.

Table 8: Rope twist and laylengths for a 48 mm rope compared to that of a 39 mm rope (empty skip conditions, and no spin lost).

	48 mm rope with a 380 mm laylength		39 mm rope with a 319 mm laylength	
	Twist	Laylength	Twist	Laylength
Front end	154°/m	323 mm (-15%)	181°/m	272 mm (-15%)
Back end	-129°/m	444 mm (+17%)	-159°/m	375 mm (+17%)

Although the twist (in degrees per metre) of the 48 mm rope is less than that of the 39 mm rope, the as-manufacture laylength of the 48 mm rope is longer. The twist in degrees per laylength is virtually the same for both ropes, and therefore the same amounts of percentage change in the laylengths.

The torque-tension-twist constants of the 48 mm triangular strand rope could not be checked versus an actual installation as was done for the 39 mm ropes of the Loraine winder. If the constants are assumed to be correct, the percentage laylength changes, for the same shaft depths and equivalent loads, will be of the same order for different diameter triangular strand ropes.

5.5 DEEP SHAFT ROPE LOADS

The back end of a triangular strand rope, which carries the greater load, will always have the longer than as-manufactured laylength. Although the Loraine experience showed no detriment from the significantly lengthened rope lay, the mean rope load and rope load range will be higher at the back end of ropes operating in shafts deeper than the Loraine shaft.

The trials carried out by Anglo American Corporation at Elandsrand have shown that triangular strand ropes perform satisfactorily at the higher loads that will be experienced in very deep shafts.

However, there is a question whether a rope with a significantly lengthened lay still has the ability to share the rope tensile load equally amongst its components (wires). If not, the wires that carry the higher proportion of the rope load will be more susceptible to "fatigue".

Intuitively one feels that load sharing will be better or more even amongst the individual wires of a rope at higher rope loads. So, even if the load sharing was not even in the Loraine rope, and if the rope loads were then still too low to generate broken wires, the intuition is that the situation will not be significantly worse at the higher rope loads that will be experienced in deeper shafts.

Nevertheless, the load distribution ability of ropes with laylengths much greater than as-manufactured can be verified either by comparative laboratory fatigue tests, and/or by actual field trials.

6. MODIFIED TRIANGULAR STRAND ROPE DESIGNS

A detailed analysis of the torsional stiffness and torque generating properties of triangular strand ropes is beyond the scope of this report. Nevertheless, the following brief analysis shows possible ways in which the construction of triangular strand ropes could be modified to reduce their laylength changes in deep shafts.

The linear model for the torque-tension-twist characteristics of a triangular strand rope describes the torque present in a rope section by the following equation:

$$T = aF + bFR + cR \quad (12)$$

where

T	=	rope torque in Nm
F	=	rope tension in N
R	=	rope twist in deg/m from the as-manufactured condition

Constant a represents the torque generated by the rope when it is tensile loaded in its as-manufactured condition. The larger part of the rope torque is generated by the angle at which the strands lay in the rope. The torque is supplemented by the torque generated by the individual strands, which have the same lay direction (Lang's lay) than the strands in the rope. (In a regular lay rope, the strand torque opposes the torque generated by the rope lay angle.)

Unlaying the rope reduces the torque generated by the angle of the strands (and for the individual strands). Laying up the rope increases the strand angles and therefore increases the torque generated by the rope. This effect is represented by constant b .

Torque is required to twist a rope. This torsional stiffness of the rope is represented by the constant c . From geometrical considerations, the torsional stiffness of a rope should not change with laylength changes in the rope. This is represented as such in Eqn 12.

The torsional stiffness of a rope could change in service when the wires on the surface of the rope get "locked together" with ever increasing surface plastic deformation. This could only happen after the initial laylength changes of a rope in a vertical shaft had taken place. The torsional stiffness increase will only give greater resistance to twist and laylength changes subsequent to the initial changes.

If the constant a of a rope could be reduced, the rope would generate less torque for the same tensile force. For a given rope size and set of winder parameters, less rope twist will then be required to restore equilibrium along the length of the rope. The laylength changes will therefore be less than for the rope with the higher constant.

None of the laylength increases calculated in this report were near the 80% limit discussed in section 1.3, p. 2. However, the laylength decrease at the rope front end, especially in deeper shafts, can easily be greater than the postulated limit of 20%. The Loraine experience has further shown that triangular strand ropes can operate satisfactorily at laylengths far greater than the as-manufactured condition. It is therefore plausible that the laylength situation for deep shaft triangular ropes can be improved by manufacturing the ropes with longer laylengths than current practice.

A triangular strand rope with an as-manufactured laylength of, say, 11 rope diameters will generate less torque for the same tensile load than if the rope was manufactured with an eight-rope-diameter laylength. The torsional stiffness of the rope should not be affected by the longer as-manufactured laylength. A longer laylength rope will require less rope twist to establish torque equilibrium. The rope will therefore distort less from its as-manufactured condition, which could only be advantageous to rope performance.

Furthermore, a longer laylength rope will also allow a greater shortening of the rope laylength before the physical strand space limits are reached.

In addition to making a triangular strand rope with a longer laylength, changes to the laylength of the wires in the strands can also be considered.

In the previous section of the report it was shown that if triangular strand ropes are to be used in very deep shafts, spin will have to be let out of the ropes to reduce the rope torque and to reduce the laylength shortening at the front end of a rope. For the same situation, longer laylength ropes will require less spin to be let out of a rope to obtain acceptable torque and laylength levels. The result will be less rope distortion from the as-manufactured condition.

7. CONCLUSIONS

The Loraine experience has shown that triangular strand ropes can operate satisfactorily with very long back end laylengths.

The indications are that long back end laylengths in deep shafts will not be a problem, but that the shortening of the laylength at the rope front ends will not be acceptable. Using triangular strand ropes in deep shafts will require deliberate letting out of a certain degree of spin in order to acquire acceptable front end rope laylengths and to reduce the torque generated by the rope.

The indications are further that different diameter triangular strand ropes will behave similarly.

Compared to the Loraine experience, there is very little reason why triangular strand ropes will not operate satisfactorily at shaft depths of at least 3 200 m.

The Loraine experience is not the limiting case and there is therefore every possibility that triangular strand ropes could be used at shaft depths of 4 000 m.

The overall laylength situation of triangular strand ropes in deep shafts can be improved by manufacturing ropes with longer laylengths than current practice.

If the Loraine experience went "unnoticed", the analyses carried out in this report would still have been possible, but the conclusions that could have been reached, would have been purely speculative.

8. RECOMMENDATIONS

The linear torque-tension-twist model, that was used for the prediction of rope behaviour in this report, should be evaluated further before a more sophisticated model is developed. The following should be done:

Obtain specimens from both the Loraine winder ropes after they have been discarded to determine whether the torsional stiffness of the ropes changed during their operation on the winder.

Measure the laylength changes and the number of turns at midshaft during skip loading directly after new ropes have been installed on a winder. It will be desirable to measure the rope torque as well. The measured values can then be compared to predicted values obtained from tests performed on samples from one or both the ropes. It will, of course, be desirable if these comparisons can be done on more than one winder.

Perform torque-tension-twist tests on triangular strand ropes of different diameters in order to verify the influence of rope diameter on laylength changes.

The laylength change of a rope as a function of rope twist is of the greatest importance, and should be measured during every torque-tension-twist test carried out.

Haggie Rand should manufacture a length of rope with a longer-than-normal rope laylength so that its torque-tension-twist properties can be compared with a standard rope. In addition they should investigate whether the strand laylengths should be changed as well.

The Loraine experience should be repeated. Laylength changes, rope torque and turns during loading should be monitored right from the installation of the ropes. A back end laylength increase of 50% compared to the as-manufactured condition should be aimed for. The possibility of using triangular strand ropes in ultra deep shafts will be advanced greatly if Haggie Rand could have a longer-than-normal laylength rope available for such a field trial.

In this report it has been postulated that, if the normal rope laylength-diameter ratio is equal to eight, a rope should distort when the laylength is decreased by more than 20% from the as-manufactured condition. This hypothesis can be checked practically during every torque-tension-twist test carried out on a triangular strand rope in future.

The internal load distribution ability of ropes with laylengths much greater than as-manufactured can be verified either by comparative laboratory fatigue tests, and/or by actual field trials. Preferably, laboratory tests should be carried out on rope samples that have sustained in-service plastic deformation of the surface wires.

The conclusive proof that triangular strand ropes are suitable for ultra deep shafts will be to install this type of rope construction on future deep shafts, or to carry out field trials (similar the Elandsrand trials) but with ropes that spin was let out deliberately.

9. REFERENCES

1. Reported by Donald Coward at the Haggie Rand Winder Rope Development Group meeting of 12 June 1997.
2. Hecker, G F K and Van Zyl, Mike: *Drum winder rope test facility: A feasibility study*. CSIR Contract Report MST(93)MC1233, January 1993.