

# **Atmospheric corrosion testing in Southern Africa**

**– Results of a twenty year  
national exposure programme**

by

**B G CALLAGHAN**

**Division of Materials Science and Technology, CSIR**



Printed in the  
Republic of South Africa by  
Scientia Publishers, CSIR

GAcsir 450H6025\*9101

---

	<i>Page</i>
<b>CHAPTER 1:</b> THE CONTROLLING FACTORS AND MECHANISM OF ATMOSPHERIC CORROSION	1
1.1 General Introduction	
1.2 Factors Controlling Atmospheric Corrosion	1
– Rain	2
– Wetting/relative humidity	2
– Atmospheric pollution	2
– Winds	3
– Radiation	3
– Micro versus macro climates	3
1.3 Mechanism of Atmospheric Corrosion	3
 <b>CHAPTER 2:</b> THE NEED FOR ATMOSPHERIC EXPOSURE PROGRAMMES AND THE RESULTS OF EARLY EXPOSURE PROGRAMMES	 5
2.1 The Need to Carry Out Atmospheric Exposure Programmes	5
2.2 Results of Early Exposure Programmes	5
2.3 Early National Exposure Programmes	7
 <b>CHAPTER 3:</b> DETAILS OF EXPOSURE SITES, METEOROLOGICAL AND POLLUTION DATA FOR THE TWENTY YEAR EXPOSURE PROGRAMME	 9
3.1 General	9
3.2 Details of Exposure Sites and Metals Exposed	10
3.3 Meteorological and Pollution Data	10
3.4 Interpretation of Meteorological and Pollution Data	11

---

	<i>Page</i>
<b>CHAPTER 4:</b> RESULTS OF TWENTY YEAR NATIONAL EXPOSURE PROGRAMME	13
4.1 General	13
4.2 Corrosion Rates After Twenty Years of Exposure	13
4.3 Discussion of Results and Conclusions	14
4.3.1 General observations	14
4.3.2 Mild steel	14
4.3.3 COR-TEN steel	15
4.3.4 Zinc	16
4.3.5 Copper	17
4.3.6 Aluminium alloys	17
4.3.7 Stainless steels and 3CR12 alloy	18
4.4 Overall Observations on Twenty Year Exposure Programme and Requirements for Continuous Updating of Performance Data	19
<b>CHAPTER 5:</b> THE APPEARANCE OF METALS AFTER EXPOSURE	21
5.1 General	21
5.2 Comments on plates	21
TABLES: 1-15	24-40
FIGURES: 1-16	41-49
PLATES 1-13	50-64
ACKNOWLEDGEMENTS	65
REFERENCES	66
ADDENDUM: Desirable Design Features	68

---

## **1. THE CONTROLLING FACTORS AND MECHANISM OF ATMOSPHERIC CORROSION**

### **1.1 General Introduction**

Atmospheric corrosion is one of the most widespread causes of metal and alloy degradation known. We only have to look at the corrosion of structural steelwork in buildings; bridges and other forms of construction to recognize the enormous wastage of materials, manpower and economic resources.

However, at the outset it is perhaps appropriate to state the reasons for writing this book. The aim is not to provide a comprehensive treaty on the mechanism of atmospheric corrosion or of all the interrelated equations by which the process occurs. The aim is to provide an adequate insight into aspects of the corrosion mechanisms and of the climatic factors that have a significant impact on atmospheric corrosion in Southern Africa. This should enable the reader to take the collected data and pictorial presentation of the appearance of metals under South African conditions and use this information to provide the most cost effective solutions to corrosion problems, yet also maintaining aesthetic standards.

It should always be borne in mind that exposure programmes based on the exposure of metal plates cannot be used in isolation. Poor design of components or structures will always lead to serious corrosion problems, even when using the most corrosion resistant materials. For this reason an addendum at the end of this book is provided to illustrate desirable design features.

### **1.2 Factors Controlling Atmospheric Corrosion**

Atmospheric corrosion may be described as the reaction of a metal to its environment. The environment can vary considerably with respect to its moisture content, temperature variations and the degree of pollution and/or other contaminants present in the atmosphere. These varying factors have made it convenient to classify any particular environment according to whether it is rural, urban, industrial, marine or tropical, with varying subdivisions and combinations of these factors.

Whatever type of atmosphere is prevalent in a particular area, it is important to realize that there will always be changes in meteorological and pollution conditions from year to year and from season to season. These changes will influence the subsequent behaviour of the metal.

From the above it is obvious that climatic factors may influence the corrosiveness of the atmosphere to varying degrees; however, as a general guide, the relevant effect of certain factors on corrosion is provided below:

### – Rain

Rain may reduce corrosion by washing away foreign material or harmful corrosion products that would otherwise promote corrosion. For example harmful deposits such as settled sulphur dioxide (SO<sub>2</sub>), soot or hygroscopic contaminants may be diluted and washed away before the metal's protective film is disrupted. On the other hand the rain may be just sufficient to dampen or wet the metal, allowing the formation of a surface electrolyte to promote corrosion. Alternatively the rain itself may be corrosive (e.g. acid rain) again promoting corrosion. However, on balance, precipitation is thought to be beneficial and likely to reduce corrosion.

### – Wetting/relative humidity

The wetting of metal surfaces by condensation, for example by morning dew or from settling of fog or mist, is likely to increase the corrosion rate. Thus the dew point, relative humidity and the hygroscopic (i.e. moisture absorption properties) nature of settled nuclei are important. The importance of the length of time a metal is wet, often referred to as the "time of wetness", is considered to be critical to atmospheric corrosion<sup>(1,2)</sup>.

Vernon<sup>(3,4)</sup> carried out a series of classical experiments and demonstrated that in the absence of rain, gaseous or solid pollutants in the atmosphere, serious corrosion does not occur when the relative humidity of the atmosphere was below a certain critical level. The critical relative humidity for steel is approximately 70% (Figure 1), above which there is a steep increase in the corrosion rate although there may be no apparent moisture on the metal's surface. The importance of the concept of a critical relative humidity becomes apparent when we look at the annual variations in the relative humidity, which is covered in Chapter 3. At approximately 70% relative humidity, a thin invisible moisture film is present on the metal's surface and this provides the electrolyte for a corrosion cell.

Thus relative humidity, combined with the "time of wetness" (related to dew point) and temperature (increasing temperature will allow the "wetness" to dry quickly) all play an interrelated role in promoting corrosion.

### – Atmospheric pollution

Vernon<sup>(3,4)</sup> was the first to describe the accelerating effect of SO<sub>2</sub> on corrosion as a function of humidity. Other overseas studies have also demonstrated the correlation between the atmospheric concentration of SO<sub>2</sub> and the corrosion rate of steel and zinc<sup>(5-10)</sup>. However very little work has been done on the combined effects of various pollutants. There is evidence that ammonia (a by-product of coal burning) in the atmosphere promotes corrosion by wetting the metal's surface<sup>(11)</sup>. Other workers<sup>(12)</sup> have shown that for the same SO<sub>2</sub> content in the atmosphere, if ammonia is present (e.g. from coal burning), then water droplets (rain) will contain a higher concentration of sulphates than if ammonia was absent. As already indicated above, a higher SO<sub>2</sub> content results in increased corrosion. Thus there can be no doubt that pollution of the atmosphere plays an important role in promoting corrosion. In South Africa, its effect can be erratic and often seasonal, particularly in urban areas due to increased fuel consumption in winter. If the seasonal and daily relative humidity pattern, as outlined above, is superimposed over the pollution seasonal/daily pattern, then an understandable picture emerges to explain the corrosion pattern of South Africa. In the Highveld areas of South Africa, pollution levels increase significantly in the winter due to increased fuel consumption for heating. Fortunately, the Highveld areas are a summer rainfall area with almost no rain in winter. As a result the seasonal

relative humidity pattern for winter is one where the dew point may be reached at night, but the relative humidity is extremely low throughout the day and relatively low during most of the night. Thus, despite pollution, the level of corrosion is not very high. If the pollution had coincided with a greater humidity and a longer "time of wetness", corrosion would be more significant.

#### – Winds

Winds play an important role in that they affect the distribution of the corrosive constituents of industrial, urban or marine atmospheres. This is of particular importance in the South African coastal environments. Our coasts are often subject to heavy surf action and if this is coupled with onshore winds, a salt haze is seen moving inland. The directional effects of the wind are prominent in, for example, the Cape Peninsula and Port Elizabeth. Metal poles examined in the Cape Town area will always display severe corrosion on the side of the pole facing the prevailing South Easter. Copenhagen<sup>(13)</sup> showed that wind-borne salt is carried over 30 km inland in the South Western Cape.

#### – Radiation

Radiation from the sun shows seasonal variations and its effect on corrosion can vary. For example, radiation can cause increased corrosion by raising the temperature of a metal's surface. High intensity of ultra violet (UV) radiation can also degrade organic materials and thereby increase corrosion due to the degradation of paint coatings. On the other hand, increased temperature can reduce the "time of wetness" of a surface, thereby reducing the corrosion risk. Diurnal temperature fluctuations in South Africa may be as high as 30 °C and this can cause serious problems to coatings due to thermal cycling.

#### – Micro versus macro climates

Whilst the general Durban environment may be described as either an industrial-marine or an urban-marine environment, the corrosion rate may vary considerably depending on where the metal is exposed. The seaward side of the Bluff is a very severe marine climate. The corrosion rate drops very significantly in the lee of the Bluff as a result of the protection provided by the hill forming the Bluff and the fact that the sea water in Durban Bay is relatively calm. Thus, it is important to distinguish between the macro and micro effects of the prevailing climate.

### 1.3 Mechanism of Atmospheric Corrosion

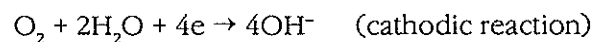
Most metals are derived from ores which undergo many metallurgical processes and refining before the final product is produced. The basic cause of corrosion is the instability of the metal in its refined form. The process of corrosion is, essentially, the metal reverting back to the ore from which it was originally derived i.e. back to a stable state (the law of maximum entropy).

Many metals automatically form a thin oxide film on their surface and in some instances this film is self healing and thus protective. This is the reason why some metals corrode easily whilst others are corrosion resistant. For example, the oxide films present on mild or unalloyed steel surfaces tend not to be adherent or continuous, and corrosion begins rapidly at breaks in the mill scale of hot rolled structural steel. On the other hand, the films formed on zinc and aluminium, normally considered to be very reactive metals, tend to be continuous, adherent and may even be self healing. For this reason these metals can be used unprotected in certain

atmospheres and they will provide a useful service life without additional protective measures.

As has already been stated, corrosion is the reaction of a metal to the environment. Obviously, therefore, both the metal and the environment are important factors in determining the rate at which the metal will corrode. The mechanism of the corrosion process is electrochemical. Essentially current (electrons) flows between active areas on the metal's surface, known as "anodic sites" to other areas known as "cathodic sites". This results in the formation of an electrochemical cell, which in many ways can be compared to a simple torch battery. The battery has an external zinc outer casing which corrodes internally (i.e. the active anode) releasing electrons. The battery (or electrochemical cell) has a central carbon core which acts as the cathode. The flow of electrons (electricity) is shown by lighting up a small torch bulb.

In the case of steel, the anodic areas may be breaks in the millscale (for example on hot rolled steel), inclusions, discontinuities or possibly the effect of pollutants on the oxide film of the metal. The electrochemical activity causes destruction of the metal at the anodic site and is accompanied/balanced by another reaction at the cathodic site. Electrons arising at the anodic site as a result of the corrosion process are always discharged at the cathodic site to maintain electrical neutrality. In atmospheric corrosion the cathodic reaction usually involves the consumption of oxygen from the air. The two reactions are typified below:



It is, therefore, not unusual to find that the controlling factors in atmospheric corrosion are the presence of a thin film of moisture on the metal's surface (e.g. effect of high humidity), atmospheric pollutants (e.g. sulphur dioxide in industrial areas), proximity to the ocean (e.g. wind-borne chlorides) and oxygen availability. Oxygen is obviously abundantly available in the atmosphere, but its access to the cathodic area may be limited by thin films (e.g. water, paints, oils, greases), by crevice effects (e.g. design of structure) and by excess water (e.g. poor drainage from gutters, roofs etc.). Bimetallic couples (e.g. brass fasteners on steel) will also promote corrosion; one of the metals will act as an anode, the other will support the oxygen reduction cathodic reaction.

The above examples serve to illustrate the electrochemical nature of atmospheric corrosion and how the climatic factors of humidity, pollution, temperature, rainfall etc., all play a role in providing, maintaining or removing the electrolyte which will support the electrochemical cell formed on a metal's surface.



## **2. THE NEED FOR ATMOSPHERIC EXPOSURE PROGRAMMES AND THE RESULTS OF EARLY EXPOSURE PROGRAMMES**

### **2.1 The Need to Carry Out Atmospheric Exposure Programmes**

Many studies have been performed in order to measure and correlate all the various climatic factors with actual corrosion rates<sup>(1,9,14,15)</sup>. Complex formulae have been developed to try and predict corrosion rates on the basis of meteorological data only. Most of these formulae have so far proved to be very inaccurate and it was realized that if reasonable correlations were found, it was somewhat fortuitous because many of the factors in the system were unaccounted for in the equations. Complete predictability would have to be based on comprehensive climatic data, a complete understanding of the total system involved and also the quantitative interrelationship between many of the factors.

In countries like South Africa, adequate climatic data is not available and we suffer the additional misfortune that our climate often functions in a "feast or famine" manner. Droughts of up to seven or eight years are not uncommon and this alone makes simple equations difficult. Thus, long-term exposure programmes are essential to provide the information so necessary for users of materials in our various climatic zones. Once this basic information is provided, shorter exposure periods can be interpreted in times of drought or flood against the background of a reasonably comprehensive long-term exposure programme, i.e. the yardstick is provided. Newly developed alloys, new coating systems or alternative materials of construction will always be tested against the yardstick of known performance.

Performance data, as provided by exposure programmes such as these described here, serves as the datum level on which all future developments in the performance of materials can be assessed. A measurable standard will have been set.

### **2.2 Results of Early Exposure Programmes**

A reasonably comprehensive survey of early exposure programmes in Southern Africa has been published<sup>(16)</sup>. The earliest reports are on the corrosiveness of the South African coastal atmospheres<sup>(17,18)</sup>, however the first report providing quantitative data on corrosion rates was that of Hudson and Stanners<sup>(7)</sup>. They reported results on ingot iron, zinc and copper bearing steel, based on one year exposure periods extending over twenty years at Congella, Durban as part of a world-wide exposure program. A wide range of corrosion rates was reported (Table 1) and this was attributed to differences in climatic conditions and the degree of atmospheric pollution. Some specimens were exposed for five years and these indicated that the corrosion rate of the ingot iron decreased with time whereas the corrosion rate of

zinc remained constant. Copper-bearing steels (0,28% copper, 0,10% nickel, 0,20% carbon and 0,58% manganese) exposed for one year showed a corrosion rate approximately 0,7 times that of the ingot iron.

Godard<sup>(19-21)</sup>, Godard and Ferguson<sup>(22)</sup> and Booth<sup>(23)</sup> carried out exposure testing on the roof of the Addington Hospital building in Durban. This site is a flat roof surrounded by a parapet wall, approximately 16 m above ground level and some 200 m from the sea. Metals were exposed at 30° to the horizontal, facing north (i.e. facing the sun's trajectory). The results of the exposure of sheet alloys are summarized in Table 2 and those of the extrusion alloys in Table 3.

Of the sheet metal alloys exposed, AISI type 302 stainless steel proved to be the most corrosion resistant alloy. It had developed a thin continuous rust film over twenty years which, although unsightly, was quite superficial. A few mild steel specimens were exposed for short periods (approximately two years), the corrosion rate varying between 4,4 (112 µm) and 7,0 (178 µm) mils/year. These results are similar to those reported earlier by Hudson and Stanners<sup>(7)</sup>. The corrosion rate for copper, lead and monel metal showed the anticipated falling corrosion rate with time. The corrosion rate for zinc was comparatively high and tended to remain constant for the ten year exposure period.

The corrosion rates for the aluminium sheet alloys decreased with time and after ten and twenty years of exposure, the difference between alloys was negligible. The pitting penetration rate for sheet alloys fell off rapidly with time so that the maximum pit depths, even after twenty years, increased only marginally over those measured after the initial two year period. In the case of the extrusion alloys the authors made the following observations: For up to five years of exposure the corrosion pattern was similar to that of the sheet alloys. However, at the ten year stage, blistering of the 24S-TB and 26S-TF angles was noted. In the second ten year period the attack proceeded rapidly with the result that no "sound" metal remained in some areas of the specimen. The exposure of anodized (10 µm thickness) 50S-TE alloy showed that anodizing contributed considerably to this alloy's performance.

Doyle and Godard<sup>(24,25)</sup> assessed the corrosive nature of the East London, Port Elizabeth and Durban atmospheres using the "wire-on-bolt" (sometimes called CLIMAT) technique. In this technique, aluminium wire is wound onto steel, copper and plastic bolts and exposed for a period of 90 days. After exposure the mass loss of the aluminium wire is determined. Based on numerous CLIMAT exposures throughout the world, Alcan of Canada have formulated their own corrosivity index which provides a quick and inexpensive method of assessing the relative corrosivity of a particular site. In the South African experiments, specimens were exposed for 90 days at varying distances from the sea. The results indicated that the East London atmosphere was somewhat more aggressive than that of Port Elizabeth. At both locations the corrosion index decreased rapidly within the first 800 m from the ocean (by 85% in Port Elizabeth and 50% in East London) and appeared to level off at about 1,6 km inland. Similar tests in Durban showed an 80% decrease in the corrosion index within the first 800 m inland. It should be noted, however, that although the "wire-on-bolt" tests are useful as a quick method of assessing the corrosivity at a site on an index basis, no actual corrosion rates are provided or implied.

Durban and Port Elizabeth showed another interesting characteristic in that, after falling dramatically within the first 800 metres inland, the corrosion index began to rise again with distance from the sea. This is attributed to the rise in the land and prevailing salt laden winds off the sea.

### 2.3 Early National Exposure Programmes

The results reported above were based almost entirely on exposures in the Durban area with the bulk of the information covering the aluminium alloys. The CSIR, with the co-operation of several industries, initiated a series of national exposure programmes to characterize the performance of metals in various areas of Southern Africa. Initially, two four-year exposure programmes were undertaken; one of these covered the exposure of metals and alloys<sup>(16,26)</sup> and the other covered metallic coatings on a steel substrate<sup>(27)</sup>. The intention was to correlate the four year corrosion rates with those of other programmes being carried out internationally, thereby avoiding the necessity for long-term exposure programmes.

The four year programmes covered a range of metals, metal coatings and also a number of sites throughout the country. The results are presented in Table 4. Whilst these results were informative, a number of shortcomings were noted and it was deemed necessary to initiate a long-term exposure programme - a twenty year exposure programme - to provide the information required. Important shortcomings noted in the initial four year programme included:

- Some sites were not considered representative of the areas they were intended to characterize.
- Directional racks included in the first programme clearly showed that it was advisable to face racks towards prevailing off-sea wind directions in coastal areas. Racks facing the Equator, as advocated by the ASTM, are suitable for organic based coatings.
- South Africa's varied climatic conditions, with wide extremes from year to year (for example seven to eight year periods of drought are not uncommon), do not lend themselves to short-term exposure programmes.
- Information on the effects of industrialization in the Highveld areas was lacking.

The new twenty year exposure programme took cognizance of these short-comings.



### **3. DETAILS OF EXPOSURE SITES, METEOROLOGICAL AND POLLUTION DATA FOR THE TWENTY YEAR EXPOSURE PROGRAMME**

#### **3.1 General**

As a result of the experience gained with the four year exposure programmes, the twenty year exposure programme included various aspects aimed at meeting requirements imposed by South African conditions:

- Several sites were chosen as major sites and a full range of metal specimens exposed at these sites. Selected metals were exposed at subsidiary sites which were chosen to provide additional information relative to local conditions.
- The choice of major sites was confirmed by exposing 90 day "wire-on-bolt" corrosion monitors (CLIMAT units) to assess the corrosivity of the site and to ensure that the sites were in fact a macro climate and not a micro climate due to some as yet unknown factor. The CLIMAT units were developed by Alcan International Research in Canada and are available from Hulett's Aluminium in South Africa. The CLIMAT test is used extensively overseas as a quick, easy and inexpensive method of assessing the corrosivity of a location. However, as has already been indicated in the previous chapter, although this technique is extremely useful as a guide to the corrosiveness of a site, it cannot be used to provide actual corrosion rates for various metals at that site.
- The racks were designed to expose the metal plates at an inclination of 60° from the horizontal and the racks placed to face the prevailing weather conditions.

Besides the above general information, several specific points of departure from the early programme were implemented and cognizance should be taken of these points in any comparison between the new and old programmes:

- 1) The main site at Cape Town has been moved from Ysterplaat, some 10 km inland from the city, to the Docks where the effects of sea and pollution are probably more representative. Subsidiary sites were established elsewhere to "fill in" the expected variations of the Cape Peninsula area.
- 2) The site at Walvis Bay was identical to the early programme, except that the racks were turned to face prevailing weather conditions and not North.
- 3) In the early four year programme, Mamelodi Township near Pretoria was selected to provide information on the effects of atmospheric pollution in the Highveld area. This was not successful hence the inclusion of the Pretoria-Iscor and Sasolburg sites to provide information in this respect. The Highveld areas represent the high plateau inland area of the country, some 1 500 to 2 000 m above sea level with a summer rainfall and characterized by low relative humidity,

particularly in the winter months. Besides being a large agricultural area, the Highveld contains major urban areas, a concentration of South Africa's mining industry and most of the country's industrial complexes. When the programme was started, heavy pollution of the Eastern Transvaal Highveld was not a problem. However today ESKOM produces some 60% of the African Continent's electricity<sup>(28)</sup> and has indicated that some 80% of South Africa's electrical power requirements are generated by coal-fired power stations in the Eastern Transvaal Highveld region alone<sup>(29)</sup>.

- 4) In the earlier four year programme 1,6 mm plate was used for all specimens. This led to assessment problems with steel plates in severely corrosive areas. For this reason 6 mm steel plates and 5 mm COR-TEN plates were used in the twenty year programme. Greater accuracy was also achieved in mass determinations in the new programme. As a result of these changes the reported corrosion rates should therefore be more accurate.

### **3.2 Details of Exposure Sites and Metals Exposed**

A full range of metals were exposed at five major sites so as to provide comprehensive data at a representative cross-section of South African climatic areas. Six subsidiary sites were chosen to provide additional information in those cities/ areas where the major site required greater clarification because of local circumstances, for example aspects such as prevailing winds, fogs, specific pollution and geomorphological features. Table 5 provides details of the test sites whilst Table 6 provides details of the metals and alloys exposed.

The specimens were exposed in five sets of three, and one set at a time was removed after two, five, ten, fifteen and twenty years of exposure. The specimen size was 205 x 125 mm (8 x 5 in), and all specimens were 1,6 mm thick (16 gauge) except mild steel (6 mm) and COR-TEN steel (5 mm). Specimens were cleaned before and after exposure using normal ASTM procedures. Mild steel specimens were weighed accurately to 0,1 g; COR-TEN and zinc to 0,01 g; and the copper, aluminium and stainless steels to 0,0001 g. The twenty year programme began in 1970. The results from the two, five and ten years of exposure have already been published<sup>(16,30,31)</sup>.

### **3.3 Meteorological and Pollution Data**

The meteorological and pollution data for the sites are presented in Tables 7-13. The meteorological data for the particular area is generally based on the longest period of collection, collated by the South African Weather Bureau<sup>(32)</sup>. Air pollution data has been extracted from several reports<sup>(33-42)</sup> and collated to coincide with the twenty year period of the exposure programme. These results are presented together with the monthly average rainfall and the temperature and relative humidity at three periods of the day (08h00, 14h00, 20h00) again on a monthly basis.

In areas other than Cape Town, the long-term SO<sub>2</sub> pollution trend for the winter months is also presented and indications given as to whether the pollution level is increasing, decreasing, or relatively unchanged over the years. The reason for presenting winter SO<sub>2</sub> pollution levels is because of the increased pollution in winter months coupled with the lack of rain to wash down or dilute settled pollutants. The hygroscopic nature of the pollutants will obviously also play a role in increasing corrosion. On the other hand, as Cape Town is a winter rainfall area, the summer pollution data becomes more relevant for corrosion, thus the summer trend is

presented for this site. Pollution data has in general been extracted from those pollution monitoring sites closest to the atmospheric corrosion site. As the meteorological data is relevant to an area, the closest monitoring site was again chosen, however in most instances this was usually at the local airport.

### **3.4 Interpretation of Meteorological and Pollution Data**

All too often the presentation of meteorological data has little meaning to a person trying to assess whether a site will be corrosive or, equally important for painting contracts, whether conditions are suitable for surface preparation and coating. Tables 7 to 13 will help to understand the climatic factors if approached in the following manner.

- 1) The rainfall and temperature distribution throughout the year is important in that, for example:
  - Low rainfall in winter with low temperature, particularly overnight, will indicate heavy dew and wetting of surfaces (e.g. Transvaal). Very low temperatures will freeze water and it is then not available as an electrolyte.
  - Minimum summer rainfall, relatively high temperatures and strong winds off the sea indicates that strong directional corrosion effects can be anticipated (e.g. the summer South Easter winds in the Cape).
  - Washing effects of rain when associated with wind suggest that corrosion will not be as severe or as directional (e.g. North Westerly winds in the Cape winter).
  - Rain throughout the year (e.g. Port Elizabeth) may have a moderating effect on corrosion despite winds.
- 2) As has been described in Chapter 1, relative humidity plays an important role in corrosion processes. It was also indicated that a critical relative humidity (RH) at which corrosion becomes more significant exists at 70% RH for steel. To make interpretation of relative humidity meaningful in terms of time of day and time of year, humidity isograms are presented in Figures 2-6<sup>(43)</sup>.

In these graphs, points of equal relative humidity are connected and this provides a quick way of assessing the effect of changing relative humidity throughout the day over a year. Where the relative humidity exceeds the 70% critical relative humidity, this area has been accentuated by shading.

Important points to note are:

- Figure 2, although specific for Jan Smuts Airport, is typical of most of the Highveld areas as represented by the Pretoria and Sasolburg exposure sites. At a glance it can be seen that the relative humidity is low throughout the daylight hours, and only exceeds 70% for the summer evenings. Obviously high atmospheric pollution coupled with lengthy "time of wetness" periods are required for very serious corrosion. Fortuitously the winter months, also the time of high atmospheric pollution, are also essentially periods of low relative humidity throughout the day.
- Figure 3 represents conditions at Cape Town. The pattern is very different to the inland Highveld areas. The relative humidity exceeds 70% during the

nights throughout the year and the effect of winter rainfall is also accentuated. Fortunately the Cape has relatively dry summer daylight hours to dry the metal's surface and in winter the metal will be washed by rain. However, as indicated earlier, the prevailing South Easterly wind of the summer months coupled with proximity to the sea, must be included in assessing this climatic zone.

- Figure 4 provides an insight into the Port Elizabeth environment. The rainfall distribution throughout the year is reflected and, as with Cape Town, the daylight hours would tend to dry a metal's surface. Again wind and rain coupled with proximity to the sea should be included in assessment of this area.
  - Figure 5 is of East London and represents the area between Port Elizabeth and Durban. Immediately visible is the increasing role of relative humidity. If this is then coupled with increasing temperatures, wind and rain patterns (rain throughout the year but tending towards summer rainfall), then East London can be anticipated to be relatively corrosive. Although corrosion rates have not been measured for East London, observations tend to confirm the corrosivity of the area.
  - Figure 6 clearly illustrates the extremely high relative humidity for the Durban area throughout the year. Again if this is coupled to winds, proximity to the sea and increased temperatures, then Durban can be expected to be highly corrosive. The Durban corrosion experience confirms these observations!
- 3) The information on pollution obviously cannot be interpreted on its own, but must also be related back to the rainfall, temperature and relative humidity patterns described above. Atmospheric pollution in all of the coastal areas can only contribute significantly to corrosion. Prediction in the Highveld is difficult as the "time-of-wetness" is all important. If our Highveld areas had, in general, a higher relative humidity, then corrosion would become more significant. Micro climates where extremely high humidity is created at a particular local area, could create severe local corrosion.

However, if pollution is allowed to increase significantly, the hygroscopic nature of the pollutants could change the pattern of corrosion. The winter trends for SO<sub>2</sub> in our cities, as provided in Tables 7 to 13, suggests that in most instances the cities are beginning to get tighter control on pollution.

- 4) The heavy surf action along our coast line, coupled with onshore winds, results in wind-borne sea salts (chlorides) being carried inland. This must be taken into account in assessing areas close to the coast. Wind-borne chloride is not pollution, but nevertheless a factor of importance to the performance of metals, coatings and concrete structures.
- 5) The relative humidity should not be the sole criterion when considering whether meteorological conditions are suitable for paint application. The steel temperature should be at least 2 °C above the dew-point temperature, especially when coatings are water sensitive.



### **4. RESULTS OF TWENTY YEAR NATIONAL EXPOSURE PROGRAMME**

#### **4.1 General**

In this chapter we present the corrosion rates of metals and alloys after twenty years of exposure as well as the more recent results (up to ten years) for the new additions to the programme. In addition, those results arising from the incorporation of new exposure sites such as Port Elizabeth, Gobabeb (Namib Desert) and Strandfontein on the False Bay coast of the South Western Cape, are also detailed.

Shorter term results are also presented from those sites where exposure programmes were initiated but where the sites were abandoned due to problems of security or inadvertent damage (Pretoria-Iscor and Simonstown sites).

Three new sites have recently been established in the Eastern Transvaal Highveld area to assess the effects of pollution arising from power generation and the synthetic fuel plant at Secunda. Unfortunately it is too early to present any results from these sites. The funding for these three sites has been provided by the Department of Health.

The results from all the previous exposure programmes were presented as tabulated corrosion rates. Our five and ten year results included graphs showing trends with time for the various sites. In this publication, colour photographs are included as it is considered important to present the appearance of metals, alloys, patinas and other distinctive characteristics arising from twenty years of testing.

#### **4.2 Corrosion Rates After Twenty Years of Exposure**

The corrosion rates after two, five, ten, fifteen and twenty years of exposure at the major sites are presented in Table 14. Also included in this Table are the subsidiary sites of Port Elizabeth and Gobabeb, where the results after one, five and ten years of exposure are presented, whilst the results after two years are presented for Simonstown and Strandfontein in the South Western Cape and the two and five year results for the Pretoria-Iscor industrial site.

Table 15 provides the results after ten years of exposure for the 3CR12 alloy incorporated into the programme at a later stage in both the pickled and the hot rolled condition. Mild steel and COR-TEN A steel were re-exposed to provide correlation between the older and newer exposure programmes and also to establish the role played by the presence of mill scale. The results of the pickled 3CR12 alloy have also been shown in Table 14 for comparative purposes. It should be noted, however, that 3CR12 is a corrosion resistant steel containing 12% chromium and not a true stainless steel; its tabulation under the stainless steels is purely for comparative purposes.

## **4.3 Discussion of Results and Conclusions**

### **4.3.1 General observations**

The general trends noted earlier in the programme have continued through to the twenty year stage. For example, the corrosion rate has generally decreased with increasing time due to the formation of protective oxide films. This feature was noted with minor exceptions. In the literature on atmospheric corrosion, it has always been reported that the zinc corrosion rate tends to remain steady with time. This trend appears to be confirmed at most of our sites, the exception being Durban Bluff where the rate has decreased with time, but nevertheless remains very high.

Figure 7 provides a histogram depicting the average corrosion penetration (in microns) after twenty years exposure for seven different metals at the various sites. This allows a comparison of how the metals performed relative to each other and also allows site comparisons. Care must be exercised in using this histogram as penetration data is presented on a log scale to enable complete capture of data on a presentable graph. If mild steel is used to assess these results, it is obvious that the Bluff is by far the most corrosive site, followed by Walvis Bay and then the Durban Bay Head site. The other coastal sites of Cape Town, Strandfontein (Cape), Simonstown and Port Elizabeth are of a similar order of corrosivity. The corrosivity of the inland polluted Pretoria-Iscor and Sasolburg sites were similar to the coastal sites. In assessing these sites, cognizance must be taken of the fact that the length of exposure at some sites, e.g. Strandfontein, Simonstown, Port Elizabeth and Pretoria-Iscor is less than the twenty years achieved at other sites and therefore the corrosion rate should fall off with time. In some of the figures these results have been extrapolated to twenty years. For example, in Figure 7 the Port Elizabeth, Simonstown and Strandfontein results have been extrapolated through to twenty years to allow comparison with the other sites. Obviously such extrapolations should be treated with caution. Another general feature to be noted when comparing sites is that if another metal, for example zinc, is chosen as the assessment criteria in terms of site aggressivity, the ranking would change.

### **4.3.2 Mild steel**

Figures 8 and 9 show the performance of mild steel at the various sites after twenty years of exposure.

From Figure 8 it can be seen that the Bluff is obviously a severely corrosive marine environment in terms of mild steel exposure, the average corrosion rate being of the order of 220 microns/year. Despite using 6 mm thick steel plate, corrosion advanced so rapidly that complete penetration of the plate had occurred after ten years. Walvis Bay is also extremely corrosive to mild steel. To place the other coastal sites and the less corrosive areas in perspective, Figure 9 presents the less severe sites, using a different scale for the corrosion penetration. By comparing these two figures and also considering the Humidity Isograms of Figures 2 to 6, the following conclusions are considered applicable.

Coastal areas which are subject to high relative humidity, reasonably high temperatures and also subject to wind-borne salt (up to 10 km inland), must be considered as a severely corrosive marine environment and all corrosion protective measures chosen accordingly. The Natal north and south coasts, extending down the coast to

East London, probably fall into this category. The west coasts of South Africa and Namibia which are subject to the early morning mists and salt, as represented by the Walvis Bay exposure, must also be considered as a severely corrosive marine environment. This belt probably extends south of Port Nolloth, at which stage the climatic conditions tend towards those of the South Western Cape. Considering the rest of the coastal area, as we move out of the high humidity/temperature of the eastern coast, and out of the mist belt of the west coast, conditions become typified by the corrosion rates shown by the coastal sites of Cape Town, Simonstown, Strandfontein and Port Elizabeth. These could be assessed as an aggressive marine climate in terms of corrosivity.

Based on the above observations, coastal areas, with their attendant corrosion risk, can be defined as those areas between the coast line and an imaginary line some 30 km inland, or up to the top of the escarpment or the watershed of the first mountain range inland. The first 5 km inland must be treated as particularly severe, but this can extend up to 10 km. This demarcation line has been chosen based on observations at our coastal cities, coupled to the corrosion rates reported here. Our South African beaches and shorelines are often areas of intensive wave action and if coupled to the onshore winds and relatively low rainfall (as compared to Europe and the USA), the corrosive zone extends further inland than on most other continents. Wire on bolt measurements conducted by Huletts Aluminium Limited on corrosivity as a function of distance from the sea, have confirmed this observation<sup>(24,25)</sup>.

Proceeding inland, the dry Highveld areas of South Africa characterized by low humidity and the absence of chlorides from the sea, are areas of low corrosion, as typified by the CSIR site in Pretoria and the Gobabeb site in the Namib desert. These areas are classified as rural or desert or semi-desert depending on climate and observations on corrosion. However, as shown by the Pretoria-Iscor and Sasolburg results, where industrial pollution is high, the corrosion rate for steel can rise to levels not dissimilar to our coastal areas. This area has been classified as inland industrial. The climatic conditions and pollution levels present in the Eastern Transvaal Highveld would fall into this category of corrosion and the Sasolburg results are probably applicable. Three new sites have been established in the Eastern Transvaal to confirm this prediction. Some areas at coastal cities e.g. Cape Town and Durban, combine marine and industrial conditions. These are classified as marine industrial.

Where mild steel was re-exposed at the various sites (see Table 15), the corrosion rates after ten years were of the same order as previously noted. The presence of mill scale on mild steel was found to have no significant effect on the corrosion rate of the mild steel. The effects of the long drought of approximately eight years could be noticed at some of the sites, particularly at the Walvis Bay site (where the mists were less frequent) and the unpolluted CSIR site. The effect of chloride at coastal sites or industrial pollution tended to mask the effects of the drought.

The observations, based on the corrosion rates of mild steel, have been used to draw up a schematic atmospheric corrosion map depicting the areas described above (Figure 16).

### **4.3.3 COR-TEN steel**

The results of the exposure of COR-TEN steel are summarized in Figure 10. With some exceptions, the effect of alloying steel with small additions of copper and

chromium produced a significant drop in the corrosion rate when compared to mild steel. However, this was not consistent or predictable as shown in Tables 14 and 15. In the original programme (Table 14) corrosion rates for COR-TEN in Cape Town, were significantly lower than that of mild steel. When re-exposed the COR-TEN corroded at the same rate as mild steel. Other points noted were:

- The Walvis Bay site is more aggressive to COR-TEN than the Bluff i.e. the site ranking changes as compared to mild steel.
- At Walvis Bay the corrosion products on the steel and on COR-TEN adhered to the specimens, even after twenty years of exposure. This created a thick slab of rust which acted as a poultice (see Plate 2). This rust retention probably explains why the COR-TEN corrosion rate was higher than that of steel in the first ten years. After fifteen years of exposure, the COR-TEN corrosion rate had fallen to almost that of mild steel.
- Although in many instances the corrosion rate of COR-TEN was lower than that of mild steel, it was nevertheless high. For example, although the corrosion rate at the Bluff was significantly less than that of mild steel, the corrosion rate was still equivalent to that of mild steel at Walvis Bay - a level of corrosion that would be totally unacceptable.
- In general, the corrosion rate of COR-TEN steel at coastal sites was unacceptably high.
- The appearance of the corroded COR-TEN specimens varied significantly from site to site, both in terms of colour and texture (see Plate 2)
- Pickled COR-TEN performed well at the inland sites (Table 14) but did not perform as well when exposed in the hot-rolled condition. However, part of the mass loss determination will include removal of the scale, thus these results must be interpreted with care.

#### **4.3.4 Zinc**

The performance of zinc at the various sites is shown in Figure 11. Walvis Bay is interesting in that zinc is particularly prone to corrosion in this environment. The zinc corrosion products remain tightly adherent to the specimen resulting in a poultice like product which corrodes right through the plate (see Plate 3). After five years the plates were holed. The average corrosion rate for zinc at the five year stage was 82 microns/year whilst that for steel was 107 microns/year. Whereas the corrosion rate for zinc tends to remain reasonably constant with time, the rate for mild steel will fall with time. The corrosion rate for mild steel at the ten year stage had fallen to 84 microns/year, i.e. roughly equivalent to that of zinc.

By contrast, the corrosion rate of zinc at the Bluff at the ten year stage was 1/20th that of mild steel, but was nevertheless unacceptably high at this site. The zinc corrosion rate at the Strandfontein site was also reasonably high at this early stage (two years), possibly a reflection of pollution from the nearby sewage site. However, the proximity to the False Bay coast ( $\pm 300$  m) and the prevailing South Easterly wind are the most likely cause of the corrosion.

As zinc is commonly used as a galvanized coating on steel, it is important to assess the zinc corrosion rate as a function of its coating thickness as applied to steel

substrates. SABS 934 "Specification for hot-dip (galvanized) zinc coatings on steel sheet and strip" calls for a coating thickness of 275 g/m<sup>2</sup> for sheet as is used in most roofing applications (designated Z275). The average coating thickness for the Z275 grade would be approximately 19 microns but could be as low as 13 microns in places. Over the first two years the corrosion rate for the Bluff is 14,5 microns/year, thus roof sheeting of this grade (i.e. a coating thickness of 13 to 19 microns), could be expected to show red rust from the underlying steel within one year. Milder coastal conditions would indicate that approximately five year's life could be expected before red rust spots would be noted. Under these circumstances it would be advisable to have all galvanized steel sheet painted at the time of erection in coastal areas as this would increase the service life significantly. The use of metallic zinc protection systems in Walvis Bay is clearly not advisable.

The expected performance of galvanized steel sheeting is also depicted in the atmospheric corrosion map of Figure 16.

#### **4.3.5 Copper**

The graph illustrating the corrosion pattern for copper is shown in Figure 12. Copper is very interesting in that in Walvis Bay the corrosion rate tends to remain at a relatively constant rate throughout the twenty year period. This happens despite forming a very attractive patina which, however, is not fully protective. Copper at Pretoria-Iscor also showed a high corrosion rate initially, as it did at the new Strandfontein site. Strandfontein may have been partially affected due to proximity to the sewage works, although prevailing winds should have minimized this effect. However, copper plates were exposed for short periods of time at these two sites, thus extrapolation to provide long-term information must be treated with care.

The corrosion rate falls off with time at the other sites; the coastal sites of Port Elizabeth, Cape Town and Simonstown all are of the same order of corrosion. After twenty years of exposure, the corrosion rate for copper at the Sasolburg site had fallen to the same values as for the coastal sites, after starting off relatively high. The Sasolburg specimens had all developed an attractive protective patina. As indicated in a previous report<sup>(31)</sup>, theft of the copper specimens at the Bluff limited results to the early stages of the programme. Indications nevertheless are that although the corrosion rate started off high, it would have fallen off with time or remained constant.

#### **4.3.6 Aluminium alloys**

The results of the 3S, M57S, 50S and B51S alloys (now designated as AA3103, AA5251, AA6063 and AA6082 respectively) are shown in Figure 13, where again it should be noted that the corrosion penetration is shown on a log scale. The D65S alloy (AA6261) has not been graphed as it was only exposed at selected sites. The severity of the Bluff site is clearly illustrated and with minor exceptions (notably 3S), the Bay Head site in Durban is the next most severe, followed by Cape Town and then Walvis Bay. An examination of equivalent two year results for Simonstown, Strandfontein, Cape Town and Port Elizabeth suggests that these sites are also reasonably aggressive.

The phenomena noted at the four main sites (Bluff, Bay Head, Walvis Bay and Cape Town docks) at the ten year stage on an alloy's performance with time, appears to have been sustained. That is, at most sites, the 3S (AA3103) alloy showed the least

mass loss at the five year stage. At the ten year stage, a different pattern emerged. The M57S (AA5251) alloy tended to show the least attack, very often followed by the 50S (AA6063) alloy. This trend for M57S performing well at the coastal sites has followed through to the twenty year stage.

In appearance the aluminium alloys show their characteristic tendency towards pitting, but with time this tendency has diminished and this is reflected in the decreasing corrosion rate with increased time. Other than at the CSIR where the plates still had a metallic mirror-like finish, the coastal and polluted sites had developed a grey/white patina.

#### **4.3.7 Stainless steels and 3CR12 alloy**

The twenty year results for the three stainless steels (AISI types 430, 304 and 316) are shown in Figure 14. Also shown are the pickled 3CR12 results, extrapolated from the ten year results. Again take note of the log scale used to present results.

As expected the 316 alloy performed the best at all sites, followed by the 304 and then the 430 alloy. In terms of site aggressivity to stainless steels, the Bluff site was the most aggressive overall site, but there was no clear pattern otherwise; the Cape Town site was more aggressive to the lower chrome steels, like the 430 and the 3CR12. On removal from the racks it was clearly evident that all the stainless steels were badly stained at the aggressive sites after twenty years of exposure. This marred their appearance and if aesthetic aspects are important (for example on shop fronts) then regular cleaning would be required to maintain appearance.

As was to be expected, the trend in corrosion rates amongst the stainless steels followed the alloying content of the steels. This is clearly illustrated in Figure 14, especially when comparing the more aggressive sites like the Bluff and Walvis Bay. The 316 alloy (18Cr/10Ni/3Mo) performed better than the 304 alloy (18Cr/10Ni) which performed better than the 430 alloy (17%Cr) which again was better than the 3CR12 (12%Cr).

The ten year results for pickled 3CR12 are shown in Figure 15. It is important to put this new alloy into perspective by comparing its performance with other metals (Figure 7), against the stainless steels (Figure 14), and the relative performance of the metal on its own (Figure 15). If we examine these figures it can be seen that although it is not considered to be a stainless steel, its performance is better than that for 3S aluminium at all sites, except at the very severe Bluff and Walvis Bay sites where the difference is marginal. This suggests that the alloy could perform very satisfactorily as an uncoated rust resistant structural steel at these sites. Although not reported here, where this alloy has been protected by paint coatings, it has provided excellent results right through to the ten year stage, especially when compared to industrial coatings applied to steel substrates.

The results of the 3CR12 alloy exposed in the hot-rolled condition are also interesting. The corrosion rate was relatively high compared to the pickled version of the alloy, but fell significantly with time. At sites like Durban Bluff, the increased corrosion tendency noted as a result of the scale in the first five years of exposure, appeared to become less significant, i.e. once the scale has spalled off, its effect disappeared and the corrosion rate diminished significantly. However, pitting of the substrate beneath the hot-rolled scale was noted at the severely corrosive sites. Thus, pitting must be borne in mind when this alloy is exposed in the hot-rolled condition.

Although pitting of pickled 3CR12 was evident, this pitting did not occur over the entire area of the panels but rather in isolated areas. The pitting in these isolated areas was nevertheless less severe than what was observed on the surface of the hot-rolled panels.

Pitting of the three stainless steel alloys which were exposed was also detected at the more aggressive sites. Although a detailed evaluation of the pitting characteristics of these chromium containing alloys was not carried out for this publication, a study in this regard is being done by the CSIR and will be published at a later date.

#### **4.4 Overall Observations on the Twenty Year Exposure Programme and Requirements for the Continuous Updating of Performance Data**

When the results of exposure programmes are collated there is a tendency to rank exposed metals in terms of increasing corrosion resistance or alternatively to rank corrosion sites in terms of aggressivity. Such rankings should be treated with a reasonable degree of caution.

The ranking of metals and alloys may vary from site to site because specific conditions at a locality may influence a particular metal and hence affect the ranking order. For example, the number of days of fog per year, the abrasive quality of particular winds coming off the desert and sand blasting of metals/coatings and the putrefaction of fish products releasing hydrogen sulphide ( $H_2S$ ), all make Walvis Bay particularly aggressive to copper based alloys, zinc metal (or galvanizing) and, to some extent, mild steel or paint coated mild steel. Aluminium and stainless steel have performed well in Walvis Bay. However, we have examined low-sloped aluminium roofs and gutters in Walvis Bay and found settled sand on the roof or in gutters and this has become moist as a result of the morning fogs. Chloride has leached from the sand and, together with the poultice effect of the settled sand, this has resulted in severe pitting and penetration of the aluminium in a short period of time. Thus, generalizing or ranking of metals must be treated with care as it could lead to serious problems if the design is incorrect or if the nature of the metal's behaviour is not fully understood.

What is important about this programme of atmospheric exposure testing is that a range of metals and alloys have been exposed at selected sites. These sites have been chosen so as to provide a reasonable cross-section of expected environmental conditions and expected pollution levels for Southern Africa. Based on these sites with their particular environmental conditions and by studying the performance of the metals/alloys at these sites, the engineer, architect or end user will be in a far better position to select a material for a particular use. By having the known performance of the metal and a pictorial representation of its appearance with time, this will go a long way towards achieving the most cost effective yet aesthetically pleasing end result, having taken cognizance of possible design problems.

The provision of climatic and pollution data will also assist contractors, applicators and specifiers of corrosion control measures, with the necessary information to assess the problems they are likely to encounter in the field and which could affect the proposed protective system. For example, the data on rainfall, pollution and relative humidity could be crucial to a coating applicator in determining the likely "window" he will have at various stages of the year for carrying out abrasive blasting and applying certain coatings that are particularly sensitive to, for example, atmospheric moisture or surface wetness.

If this publication has provided the reader with a degree of understanding of the corrosion process and if the corrosion rate results and the appearance of metals after exposure are then used to choose and use metals more cost effectively, then this publication will have been worthwhile. Above all, the need to look at a construction project in a holistic manner cannot be over-emphasized. It is extremely important to consider corrosion control measures at the design stage of a project as this could influence certain aspects of the design. If approached as an after-thought once the project is completed, it is difficult to provide the most cost effective corrosion control measures and often subsequent maintenance and repair costs may exceed the initial cost of the entire project.

Continuous updating of exposure programmes is necessary so as to include the performance of new materials and coating systems, using the yardstick performance of known materials to ensure that we are indeed moving forward. Environments also change with time and this necessitates continuous updating with reference materials to ensure that we understand what variables are changing which may affect the use of existing corrosion preventive measures.



### **5. THE APPEARANCE OF METALS AFTER EXPOSURE**

#### **5.1 General**

In the building and construction industries metals are used for a number of reasons. These reasons vary from mechanical properties, ease of fabrication in terms of welding, cutting and formability, to their intrinsic appearance. Mild steel is seldom used in the uncoated condition because of its susceptibility to atmospheric corrosion and steel corrosion products are often unsightly and tend to discolour other materials in close proximity. Under certain circumstances, if aesthetic properties are unimportant and provided adequate metal thickness is used initially, it may prove cost effective to use uncoated steel. Other metals, notably the stainless steels and aluminium are used because of their corrosion resistance and their appearance. Copper, and to some extent COR-TEN steel, are used because of the attractive yet often protective corrosion products. Architects will often specify a particular material with a particular colour and/or texture in mind, based on glossy sales literature. However, in real life the appearance of a metal can vary considerably from site to site and its appearance may also change with extended exposure periods to varying climatic conditions. Maintenance or cleaning are also important to specific metals and their coatings if undesirable features are to be avoided.

In the present programme the metal plates were exposed to the elements and never cleaned or touched up in any way. Obviously rain would have washed away some of the settled dust and pollutants, but in general the specimens were allowed to weather in order to allow a comparison between metals at a site and to allow comparison of a metal at different sites. This was informative in that many of the metals chosen because of their actual appearance after exposure bore very little resemblance to that depicted in brochures.

The following Plates have been produced to enable designers, architects, engineers and end users to have a fairly good idea of the likely appearance of any structure they are contemplating.

Each Plate shows the appearance of a particular metal at the various sites around the country. Where possible the photograph of the metal at the twenty year stage is shown. However, in some instances a shorter period of exposure of the metal has been shown. The reason for this may be that it is a recent site, or the metal has corroded away extensively, or alternatively, that later samples are not available due to the plate having been stolen. Not all metal types were exposed at the subsidiary sites, thus these are indicated as "not exposed".

#### **5.2 Comments on Plates**

*Plate 1 - mild steel:* The appearance of mild steel at the various sites is shown. Several points are worth noting:

- The 6 mm mild steel plate has been completely penetrated at the severe Bluff site after ten years. The metal was re-exposed as a 3 mm plate and this is depicted in Plate 1 after five years exposure.
- Corrosion products on mild steel at Walvis Bay tended to remain intact on the specimen, creating a thick slab of rust. At most other sites, the rust tends to flake off.
- The corrosion rate of mild steel in the inland unpolluted areas is low enough for it to be left uncoated, provided this is aesthetically acceptable and that adequate metal thickness is provided.

*Plate 2 - COR-TEN:* The appearance of COR-TEN steel is illustrated in this Plate. In appearance it is almost identical to conventional steel and not the plum colour so often depicted in brochures. At Walvis Bay it developed the identical "thick slab of rust" appearance achieved by mild steel and its corrosion rate may even exceed that of steel. In coastal sites its behaviour is unpredictable in terms of both corrosion rate and appearance. Pickled COR-TEN performed well in the inland areas and rapidly stabilized on the upper surface. The lower surface that remained wet for longer periods still retained loose friable rust particles.

*Plate 3 - zinc:* Zinc behaves and looks very poor in Walvis Bay. The corrosion products stick to the metal forming almost a poultice as shown in the Plate. The Cape Town specimen had been removed by unknown persons, but in appearance was similar to the Bay Head site. Although the corrosion rate did increase with time at the Bluff, the appearance of the metal was very rough and unattractive. Zinc at the Strandfontein site showed heavy white rusting after only two years exposure. Zinc or galvanized steel coatings are not recommended for the Walvis Bay area.

*Plate 4 - copper:* The well known green patina of copper is not readily developed at all sites. It was well developed at Walvis Bay and at Sasol after the twenty year exposure period and also developed within two years on the Strandfontein site on False Bay. However, the pollution at the Bay Head and Cape Town sites resulted in a brown colour and this was also noted after ten years at Port Elizabeth. The inland rural CSIR site developed a deep brown coloration, lightened by dust.

*Plates 5 and 6 - aluminium:* The alloys 3S and M57S are shown (the 50S and B51S were almost identical in appearance to the above two alloys, and thus are not shown). At all coastal sites the aluminium developed light pitting which ultimately covered the face of the specimen, giving it an off-white cement-like colour, almost like a patina. Aluminium performed very well at Walvis Bay, unlike the zinc products. Aluminium retained its bright metallic appearance at the CSIR site. Regular cleaning of specimens would have retained the metal's appearance.

*Plates 7, 8 and 9 - stainless steel:* Whilst the stainless steels maintained their bright metallic appearance at the CSIR, staining was noted at all coastal sites. Pitting was not serious despite the staining. Staining became progressively worse from the higher 316 alloy through to the 430 alloy. The degree of staining was also a function of site aggressivity. Regular washing of specimens would have maintained the metal's bright appearance.

*Plates 10 and 11 - 3CR12 steel:* The pickled 3CR12 alloy showed more staining than the 430 stainless steel. As the 3CR12 alloy contains 12% chromium as compared to the 17% of the 430, this increased staining was to be expected. In the milder inland site the pickled specimens maintained the glossy metallic finish and the hot-rolled specimen showed little corrosion. Except for the extremely aggressive Bluff and

Walvis Bay sites, the metal would lend itself to use as an uncoated alloy retaining a fairly reasonable appearance. The pitting that might have been expected of the metal exposed with hot-rolled mill scale present (due to the development of local corrosion cells at breaks in the scale) did not materialize generally. Only at the very severe Bluff and Walvis Bay sites did relatively severe pitting occur – the average pit depth on a plate being of the order of 400 microns after ten years. The pitting which occurred on pickled 3CR12 plates was restricted to isolated areas on the plates with the severity of pitting in these areas being less than what was detected on the hot-rolled plates. In these areas the average pit depth after ten years was of the order of 250 microns. The pit depth must be viewed in terms of the overall plate thickness when considering structural integrity. Where used as thin roofing sheets, for example, the possibility of pitting should receive particular attention.

*Plate 12 - anodized aluminium:* Anodized aluminium exposed at the CSIR, Durban Bluff and Walvis Bay is shown with increasing anodizing thickness (5, 15, 20 and 25 microns thickness). No pitting problems were noted at the CSIR site, but after twenty years, extensive pitting had become prominent on all anodizing thicknesses below 25 microns at the Bluff. Pitting was beginning to initiate on the edges of the 25 micron thickness specimen at the Bluff. Anodizing performed well at Walvis Bay, despite the site's severity. Regular washing of the anodized aluminium would have made a great difference in the metal's performance at the aggressive sites.

*Plate 13 - aluminium metal spray over steel:* Plate 13 shows the appearance of aluminium metal spray (100 to 125 microns thick) thermally applied to steel using an oxyacetylene spray gun. The coating was not sealed. After twenty-five years of exposure the metal is still fully protected. Other metal and organic coatings have long since failed!

**TABLE 1**  
**Corrosion rates at Congella, Durban**  
**After Hudson and Stanners<sup>(7)</sup>**

Corrosion rate (mils/yr <sup>e</sup> )							
Years exposed	Ingot iron			Copper <sup>d</sup> steel	Zinc		
	Max	Min	Avg	Avg	Max	Min	Avg
1 <sup>a</sup>	10,4	2,5	4,5	–	0,60	0,12	0,19
1 <sup>b</sup>	–	–	4,8	3,2	–	–	0,23
1 <sup>c</sup>	–	–	3,0	–	–	–	0,18

<sup>a</sup>17 specimens of ingot iron and zinc exposed for one year periods over a period of 17 years

<sup>b</sup>One year exposures averaged for the same years as the five year tests reported in c

<sup>c</sup>Five year tests

<sup>d</sup>Copper steel 0,28%Cu and 0,10%Ni

<sup>e</sup>To convert mils/year to  $\mu\text{m}/\text{year}$  multiply by 25,4

TABLE 2

Corrosion rates and maximum pit depths of sheet alloys, Addington Hospital, Durban After Godard and Ferguson<sup>(22)</sup>

Alcan alloy or metal	Alloy type	Thickness (mm)	Corrosion rate ( $\mu\text{m}/\text{yr}$ )				Maximum pit depth (mm)			
			Exposure Period				Exposure Period			
			2 Years	5 Years	10 Years	20 Years	2 Years	5 Years	10 Years	20 Years
2S-H6	99,2% Al	1,6	1,22	0,97	0,64	0,63	0,17	0,24	0,19	0,13
3S-H4	Al-Mn	1,6	1,22	0,91	0,73	0,76	0,12	0,10	0,19	0,21
65S-TF	Al-Mg-Si	1,6	1,52	1,24	0,89	0,81	0,09	0,07	0,10	0,14
B51S-TF	Al-Mg-Si	1,5	1,22	0,94	0,84	-	0,16	0,21	0,17	-
57S-H6	Al-2,2Mg	1,6	0,86	0,81	0,61	0,53	0,19	0,24	0,16	0,20
M57S-H6	Al-2,2Mg	1,6	0,97	0,81	0,79	-	0,18	0,16	0,17	-
C54S-M	Al-3,5Mg	1,6	0,89	0,79	0,79	-	0,16	0,23	0,23	-
B54S-M	Al-4,5Mg	1,3	1,12	0,84	0,79	-	0,20	0,34	0,21	-
24S-TB Alclad <sup>a</sup>	99,5 Cladding	1,8	1,22	0,81	0,76	0,63	<sup>b</sup>	<sup>b</sup>	<sup>b</sup>	0,08
75S TF Alclad <sup>a</sup>	72S Cladding	1,6	1,40	1,04	0,79	0,51	<sup>b</sup>	<sup>b</sup>	<sup>b</sup>	0,08
M75S TF Alclad <sup>a</sup>	72S Cladding	1,6	0,97	0,81	0,78	-	0,09	0,09	0,17	-
Zinc		2,3	4,95	4,72	5,21	-				
Lead		1,8	4,14	3,89	-	-				
Copper		0,8	2,06	1,55	1,14	-				
Monel		1,3	1,96	1,63	1,42	1,52				
302 St. Steel		1,3	0,05	0,05	0,03	0,03				

<sup>a</sup>0,09 mm cladding layer per side.

<sup>b</sup>All less than 0,08 mm.

TABLE 3

Corrosion rate and maximum depth of penetration for aluminium extrusion alloys, Addington Hospital, Durban  
After Godard and Ferguson<sup>(22)</sup>.

Alcan alloy or metal	Alloy type	Corrosion rate ( $\mu\text{m}/\text{yr}$ )					Maximum pit depth (mm)				
		Exposure Period					Exposure Period				
		2 Years	5 Years	10 Years	15 Years	20 Years	2 Years	5 Years	10 Years	15 Years	20 Years
50S-TE	Al-Mg-Si	4,24	3,05	1,90	1,52	1,02	0,08	0,08	0,18	0,10	0,15
Anodized 50S-TE	Al-Mg-Si	<sup>a</sup>	<sup>a</sup>	<sup>a</sup>	<sup>a</sup>	<sup>a</sup>	0,41	0,41	1,02	0,89	0,97
24S-TE	Al-Cu-Mg	9,52	8,08	4,55	5,28	<sup>b</sup>	0,15	0,15	2,79	2,41	5,0 <sup>b</sup>
26S-TF	Al-Cu	11,18	10,77	7,37	6,22	<sup>b</sup>	0,15	0,10	0,28	0,30	5,0 <sup>b</sup>
75S-TF	Al-Zn-Mg-Cu	9,50	13,44	17,14	15,49	15,24	0,05	0,10	0,08	0,46	0,48
A56S-M	Al-Mg	1,07	1,07	0,96	-	-	0,15	0,23	0,28	-	-

<sup>a</sup>No mass losses taken.

<sup>b</sup>Areas on samples exfoliated to the extent that no sound metal remains, mass losses thus inaccurate when penetration is greater than 5 mm.

**TABLE 4**  
**Average corrosion rate results of initial four year exposure programme**  
**After Callaghan<sup>(16,26)</sup>**

Metal or Alloy	Pretoria CSIR		Durban Salisbury Island		Durban Bluff		Cape Town Ysterplaat		Walvis Bay Military Camp		Pretoria Mamelodi	
	mil/yr	µm/yr	mil/yr	µm/yr	mil/yr	µm/yr	mil/yr	µm/yr	mil/yr	µm/yr	mil/yr	µm/yr
Mild steel	0,32	8,1	5,26	133,6	11,0 <sup>a</sup>	279,4 <sup>a</sup>	1,09	27,7	7,10 <sup>a</sup>	180,3 <sup>a</sup>	0,33	8,4
COR-TEN	0,19	4,8	1,35	34,3	-	-	0,49	12,4	1,57	39,9	0,19	4,8
Zinc	0,02	0,508	0,13	3,302	0,42 <sup>b</sup>	10,668 <sup>b</sup>	0,07	1,778	0,86	21,844	0,03	0,762
Copper	0,018	0,457	0,055	1,397	-	-	0,028	0,711	0,125	3,175	0,039	0,991
<i>Aluminium</i>												
2S	N <sup>c</sup>	N	0,021	0,533	0,053 <sup>b</sup>	1,346 <sup>b</sup>	0,008	0,203	0,023	0,584	N	N
3S	N	N	0,020	0,508	-	-	0,005 <sup>b</sup>	0,127 <sup>b</sup>	0,023 <sup>b</sup>	0,584 <sup>b</sup>	N	N
M57S	N	N	0,025	0,635	-	-	0,007	0,178	0,023 <sup>b</sup>	0,584 <sup>b</sup>	N	N
B51S	N	N	0,025	0,635	-	-	0,006 <sup>b</sup>	0,152 <sup>b</sup>	0,038 <sup>b</sup>	0,965 <sup>b</sup>	N	N
<i>Stainless steel</i>												
430, 304, and 316 <sup>d</sup>	-	-	-	-	-	-	-	-	-	-	-	-

<sup>a</sup>Very approximate figure – estimated from a two year exposure, thereafter specimens disintegrated or lost.

<sup>b</sup>Approximate figure – estimated from a three year exposure, thereafter specimens disintegrated or lost.

<sup>c</sup>N = Negligible – specimens were not measured accurately enough to justify results below 0,003 mil/yr (0,076 µm/yr)

<sup>d</sup>Stainless steel specimens were rust stained at the aggressive sites. Mass loss measurements were not recorded accurately enough to justify recording corrosion rate figures.

**TABLE 5**  
**Details of test sites**

Site locality	Environment	Industrial Pollution	Identification
<i>Major sites</i>			
Pretoria – CSIR	Rural	Very low	CSIR
Durban – Salisbury Island/ Bay Head	Marine	Moderate	Bay
Durban – Bluff	Severe marine	Moderate/low	Bluff
Cape Town – Docks	Marine	Moderate	CT
Walvis Bay – Military Camp	Severe marine	Low	Walvis
<i>Subsidiary sites</i>			
Pretoria – Iscor	Industrial	High	Iscor
Sasolburg – OFS	Industrial	High	Sasol
Strandfontein – Cape	Marine	Low	Str
Port Elizabeth	Marine	Low	PE
Gobabeb	Desert	Very low	Gobabeb



**TABLE 6**  
**Metals and alloys exposed**

Metal/alloy	General characteristics/analysis (where required)				
Mild steel	0,20% C;	0,10% Si;	0,76% Mn;	0,006% P;	0,018% S
COR-TEN A	0,12% C; 0,40% Cu;	0,35% Mn; 0,72% Cr;	0,11% P; 0,65%Ni	0,05% S;	0,50% Si
Zinc	99,7% Zn;	traces Ag, Al,Mn			
Copper	tough pitch copper, 99,85%				
<i>Aluminium: <sup>(1)</sup></i>					
3S-H4	Al-Mn				
M57S-H6	Al-2,2 Mg				
50S-TF	Al-Mg-Si				
B51S-TF	Al-Mg-Si				
D65S-Aged	Al-Mg-Si				
<i>Stainless Steel:</i>					
AISI type 430	17% Cr				
AISI type 304	18% Cr	10% Ni			
AISI type 316	18% Cr	10% Ni,	3% Mo		
SX 3CR12 <sup>(2)</sup>	0,025% C; 11,45% Cr;	0,014%S; 0,40% Ni;	0,020%P; 0,21% Ti;	0,80% Mn;	0,45% Si; 0,013% N

**NOTE:** (1) Al alloys

<i>Old designation</i>	<i>New AA classification</i>
3S	= AA 3103
M57S	= AA 5251
50S	= AA 6063
B51S	= AA 6082
D65S	= AA 6261

(2) 3CR12 is a corrosion resistant alloy containing 12% chromium and not a stainless steel. However, it is included in this group among the chrome containing stainless steels, purely for comparative purposes

**TABLE 7**  
**Meteorological<sup>(1)</sup> and pollution data<sup>(2)</sup> for Pretoria site**

Period	Rainfall (mm)	Temperature (°C)			Relative humidity (%)			SO <sub>2</sub> µg/m <sup>3</sup>	Long term SO <sub>2</sub> trend (winter)
		27 years			14 years				
Time	35 years	08h00	14h00	20h00	08h00	14h00	20h00	19 years	Year (µg/m <sup>3</sup> )
January	131	19,9	26,3	21,3	72	48	66	7	1968 10
February	89	19,6	26,0	21,6	74	48	65	10	1969 12
March	90	18,1	25,1	20,1	74	45	67	11	1970 8
April	55	15,0	23,3	16,4	76	43	68	12	1971 9
May	23	10,3	20,7	12,2	75	36	66	17	1972 12
June	11	6,0	18,3	9,1	75	33	62	18	1973 9
July	7	6,1	18,3	9,9	72	31	57	20	1974 14
August	6	10,0	21,1	13,0	62	26	47	17	1975 15
September	22	15,1	24,0	17,4	56	28	47	14	1976 18
October	71	18,3	25,9	19,6	59	34	51	8	1977 15
November	115	19,2	25,6	20,0	65	41	63	7	1978 16
December	126	19,9	26,0	20,6	71	47	65	6	1979 21
Reference Source	32	32			32			33-42	1980 10
									1981 15
									1982 10
									1983 9
									1984 14
									1985 12
									1986 15
									1987 6
									1988 20
									1989 16
									No significant change

**NOTE:** <sup>(1)</sup> Meteorological data collected at Lynnwood Road site, SAWB  
<sup>(2)</sup> Pollution data for CSIR site

**TABLE 8**  
**Meteorological<sup>(1)</sup> and pollution data<sup>(2)</sup> for Durban area**

Period	Rainfall (mm)	Temperature (°C)			Relative Humidity (%)			SO <sub>2</sub> (µg/m <sup>3</sup> )		Long term SO <sub>2</sub> trend (winter) (µg/m <sup>3</sup> )		
		29 years			29 years			Bluff	Congella	Year	Bluff	Congella
Time		08h00	14h00	20h00	08h00	14h00	20h00	19 years	19 years			
January	135	24,2	26,5	23,8	77	70	84	12	50	1968		144
February	114	24,2	26,8	24,1	78	70	84	14	48	1969		55
March	124	23,2	26,5	23,5	79	68	84	14	50	1970		99
April	87	20,7	24,9	21,3	79	65	83	20	45	1971	28	91
May	64	17,2	23,3	18,5	79	61	83	32	48	1972	24	60
June	26	13,6	22,0	15,9	78	54	81	47	52	1973	9	41
July	44	13,5	21,7	16,2	79	56	81	47	54	1974	22	51
August	58	15,8	21,7	17,5	77	60	81	28	51	1975	-	33
September	65	18,7	22,0	19,0	76	66	82	19	53	1976	34	48
October	89	20,4	22,6	19,9	74	69	83	12	54	1977	48	44
November	104	22,0	23,7	21,2	74	71	84	12	55	1978	35	32
December	108	23,5	25,5	22,8	75	69	83	10	53	1979	42	41
Reference Source	32	32			32			33-42		1980	27	52
										1981	26	62
										1982	38	67
										1983	54	65
										1984	34	63
										1985	37	47
										1986	35	56
										1987	18	27
										1988	32	40
										1989	50	38
											No significant trend	Downward trend

**NOTE:** <sup>(1)</sup> Meteorological data for Louis Botha Airport

<sup>(2)</sup> Pollution data for Bluff and Congella

**TABLE 9**  
**Meteorological<sup>(1)</sup> and pollution data<sup>(2)</sup> for Cape Town area**

Period	Rainfall (mm)	Temperature (°C)			Relative Humidity (%)			SO <sub>2</sub> (µg/m <sup>3</sup> )	Long term SO <sub>2</sub> trend (summer) (µg/m <sup>3</sup> )	
		29 years			29 years					
Time	29 years	08h00	14h00	20h00	08h00	14h00	20h00	19 years	19 years	
January	14	19,5	24,7	20,0	74	52	72	34	1970/71 75	
February	17	18,6	25,0	19,7	80	52	76	36	1971/72 100	
March	19	16,7	24,2	18,5	85	52	79	39	1972/73 65	
April	39	13,8	21,9	16,3	89	55	82	32	1973/74 55	
May	74	11,0	18,9	13,8	90	61	85	23	1974/75 40	
June	92	9,5	17,2	12,1	88	62	85	22	1975/76 30	
July	70	8,6	16,6	11,7	89	62	85	21	1976/77 -	
August	75	9,1	16,7	12,2	89	60	82	19	1977/78 55	
September	39	11,5	18,2	13,4	87	57	81	19	1978/79 25	
October	37	14,6	20,1	14,9	79	53	78	28	1979/80 -	
November	15	17,6	22,1	17,0	72	53	76	31	1980/81 35	
December	17	19,2	23,6	18,9	71	53	74	31	1981/82 14	
Reference Source	32	32			32			33-42	1982/83 7	1983/84 14
									1984/85 20	1985/86 14
									1986/87 7	1987/88 8
									1988/89 10	
									Pollution trend: down	

**NOTE:** <sup>(1)</sup> Meteorological data for D F Malan Airport

<sup>(2)</sup> Pollution data for Foreshore

**TABLE 10**  
**Meteorological<sup>(1)</sup> and pollution data<sup>(2)</sup> for Port Elizabeth area**

Period	Rainfall (mm)		Temperature (°C)		Relative Humidity (%)			SO <sub>2</sub> (µg/m <sup>3</sup> )	Long term SO <sub>2</sub> trend (winter) (µg/m <sup>3</sup> )
	34 years	48 years	08h00	14h00	08h00	14h00	20h00		
January	41	20,9	24,0	20,7	77	63	81	16	1975 11
February	39	20,6	24,1	20,6	81	66	85	14	1976 25
March	55	19,2	23,2	19,8	85	66	86	14	1977 24
April	57	16,3	21,6	17,5	85	63	85	18	1978 21
May	68	13,3	20,3	15,1	83	59	84	21	1979 20
June	61	10,7	19,3	13,6	81	54	80	28	1980 21
July	54	10,4	18,6	13,4	82	55	81	25	1981 22
August	75	11,8	18,4	13,5	82	59	82	20	1982 -
September	70	14,1	18,5	14,7	81	63	83	20	1983 38
October	59	16,4	19,4	16,0	78	65	83	13	1984 28
November	49	18,4	21,0	17,7	76	65	83	13	1985 16
December	34	20,1	22,7	19,6	74	63	81	14	1986 15
Reference Source	32	32	32	32	32	32	32	33-42	1987 10 1988 9 1989 12

**NOTE:** <sup>(1)</sup> Meteorological data for H F Verwoerd Airport

<sup>(2)</sup> Pollution data for Port Elizabeth Central

No significant long term change  
Down over last 5 years

TABLE 11  
 Meteorological<sup>(1)</sup> and pollution data<sup>(2)</sup> for Vanderbijlpark [closest to Sasolburg]

Period	Rainfall (mm)	Temperature (°C)	Relative Humidity (%)	SO <sub>2</sub> (µg/m <sup>3</sup> )	Long term SO <sub>2</sub> trend (winter) (µg/m <sup>3</sup> )
16 years	16 years	10 years	10 years	14 years	13 years
Time	08h00	08h00	08h00		
January	120	19,2	69	10	1977 19
February	87	19,2	73	12	1978 30
March	68	17,5	74	12	1979 15
April	65	14,3	74	13	1980 -
May	22	9,5	70	19	1981 28
June	8	5,1	66	22	1982 29
July	11	5,6	60	26	1983 20
August	4	9,2	49	24	1984 27
September	24	13,6	52	19	1985 23
October	65	17,7	56	12	1986 14
November	102	18,7	64	11	1987 12
December	101	19,6	66	9	1988 17
Reference Source	32	32	32	33-42	No significant long term change

**NOTE:** <sup>(1)</sup> Meteorological data for Vanderbijlpark – Iscor site

<sup>(2)</sup> Pollution data for Vanderbijlpark Municipal Laboratory

**TABLE 12**

**Meteorological data for Walvis Bay/Swakopmund<sup>(1)</sup> area  
(No pollution data available)**

	Rainfall (mm)	Temperature (°C)		Relative Humidity %		Fog (days)
Period	6 years	6 years		6 years		6 years
Time		08h00	14h00	08h00	14h00	
January	0	16,2	19,3	89	79	1,8
February	4	17,1	19,8	91	80	4,0
March	1	15,9	18,8	93	82	9,7
April	2	14,2	17,6	92	83	12,2
May	0	12,7	16,4	88	80	16,5
June	0	12,9	17,6	75	69	14,0
July	0	10,4	15,2	83	76	12,7
August	0	10,0	14,0	93	83	14,3
September	0	10,7	14,0	96	85	11,8
October	1	12,1	15,0	91	81	7,7
November	0	14,3	17,0	93	84	4,8
December	0	15,1	17,6	94	86	3,7
	Total 8 mm/yr					Total 113,2 days of fog/yr
Reference Source	32	32		32		

<sup>(1)</sup> Meteorological data for Swakopmund as no long term data available for Walvis Bay.  
The close proximity of the two sites makes this comparison acceptable.

**TABLE 13**  
**Meteorological data for Gobabeb**

	Rainfall (mm)	Temperature (°C)			Relative Humidity %			Fog (days)
Period	22 years	22 years			22 years			7 years
Time		08h00	14h00	20h00	08h00	14h00	20h00	
January	5	16,4	29,3	25,1	86	35	43	9,2
February	4	16,5	29,5	25,2	86	35	43	7,0
March	6	17,8	31,9	26,8	77	31	38	5,7
April	3	16,4	30,8	24,9	65	27	36	4,0
May	1	14,7	28,7	22,6	53	22	33	2,2
June	2	12,9	26,0	20,0	51	24	36	3,4
July	0	11,7	25,8	19,8	53	23	35	6,0
August	1	10,8	25,6	19,8	61	25	38	7,7
September	1	11,2	26,8	20,7	75	27	40	11,0
October	1	12,7	27,6	21,4	79	28	42	10,5
November	1	14,4	28,8	23,1	80	28	39	13,7
December	0	15,1	29,0	24,0	85	32	43	13,7
	Total 25 mm/yr							Total 94,1 days of fog/yr
Reference source	32	32			32	32		



TABLE 14

Corrosion rate ( $\mu\text{m}/\text{yr}$ ) after two, five, ten, fifteen and twenty years at various sites in South Africa

Part one

Metal	CSIR					Durban Salisbury Island/Bay Head					Durban Bluff				
	2	5	10	15	20	2	5	10	15	20	2	5	10	15	20
Mild Steel	10,9	5,84	4,32	2,86	2,85	55,9	46,2	37,1	33,0	260	257	219			
COR-TEN A	6,10	3,56	2,29	1,48	1,50	40,6	31,5	21,1	17,0	61,5	79,5	81,0	78,1*		
Zinc	0,203	0,330	0,330	0,380	0,370	2,39	2,46	2,31	2,25	14,5	12,1	11,1	9,19	8,64	
Copper	0,838	0,813	0,559	0,382	0,384	1,45	1,27	0,94	0,91	3,25	2,46				
<i>Aluminium</i>															
3S	0,038	0,028	0,028	0,028	0,028	0,696	0,678	0,546	0,381	3,353	2,174	1,946	1,413	1,284	
M57S	0,028	0,038	0,033	0,033	0,030	0,577	0,693	0,353	0,388	2,591	2,375	1,676	1,471	1,058	
50S	0,051	0,056	0,028	0,028	0,028	0,688	0,706	0,315	0,296	2,276	2,169	2,000	1,725	1,362	
B51S	0,046	0,028	0,033	0,032	0,032	0,574	0,737	0,366	0,418	3,228	3,807	2,761		1,688	
D65S										2,713		2,364			
<i>Stainless Steel</i>															
430	<0,0025	<0,0025	<0,0025	<0,0025	<0,0025	0,0914	0,0610	0,0406	0,0279	0,3581	0,2134	0,1727	0,2616	0,2489	
304	<0,0025	<0,0025	<0,0025	<0,0025	<0,0025	0,0152	0,0076	0,0076	0,0062	0,0686	0,0356	0,0406	0,0421	0,0418	
316	<0,0025	<0,0025	<0,0025	<0,0025	<0,0025	0,0076	0,0051	<0,0025	<0,0025	0,0406	0,0254	0,0279	0,0321	0,0282	
3CR12 (Pickled)	0,007	<0,0025	<0,0025			0,194	0,159	0,104		1,256	1,576	1,722			

• Holed

(Continued)

**TABLE 15**  
**Additions to programme: Corrosion rates ( $\mu\text{m}/\text{y}$ ) after one, two, five and ten years at various sites in South Africa**

Site	CSIR Pretoria				Bay Head Durban				Bluff Durban			
	1	2	5	10	1	2	5	10	1	2	5	10
Exposure Period (yrs)	1	2	5	10	1	2	5	10	1	2	5	10
Mild Steel (HR)	13,8	9,14	4,66	3,08	65,5	53,1	42,5	34,1	231	285	†	†
COR-TEN A (HR)	14,7	9,65	4,63	2,97	41,4	30,2	17,7	▲	*	66,3	49,7	*
3CR12 (Pickled)	0,014	0,007	<0,0025	<0,0025	0,240	0,194	0,159	0,104	1,054	1,256	1,576	1,722
3CR12 (HR)	4,81	3,74	1,36	0,954	9,56	8,14	2,35	1,35	16,1	10,9	6,42	4,54

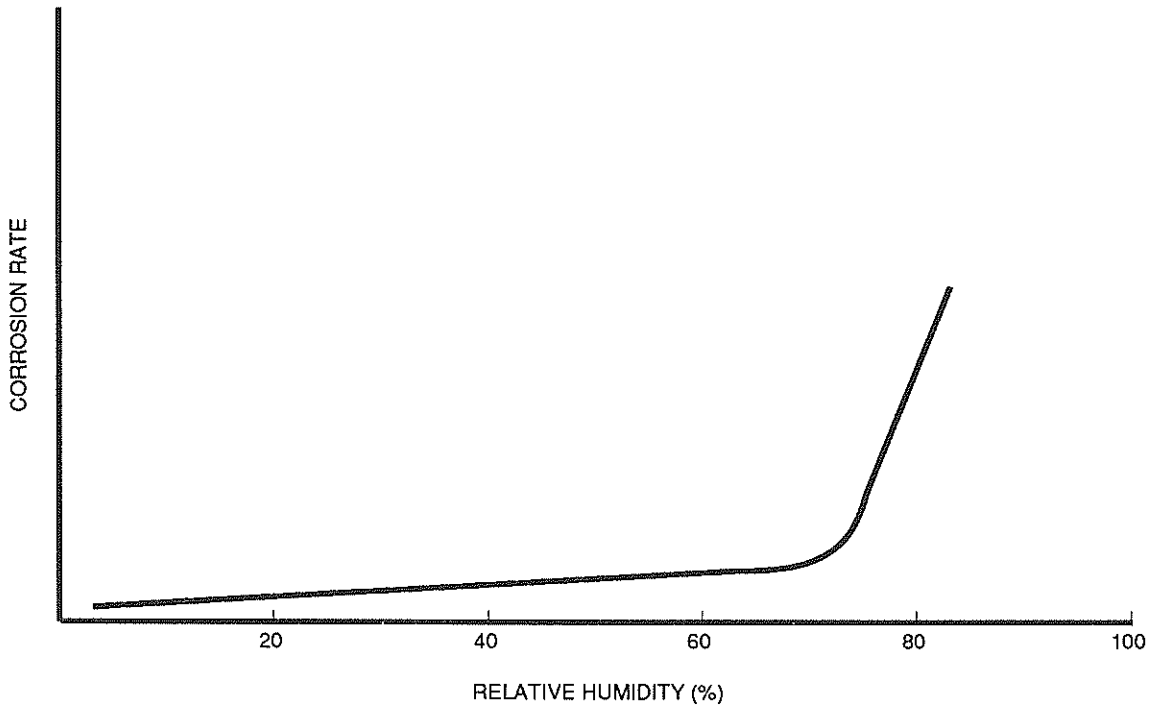
  

Site	Cape Town Docks				Walvis Bay – Military Camp				Sasolburg			
	1	2	5	10	1	2	5	10	1	2	5	10
Exposure Period (yrs)	1	2	5	10	1	2	5	10	1	2	5	10
Mild Steel (HR)	32,1	22,9	12,1	▲	165	61,4	55,0	55,0	49,8	34,0	19,6	15,1
COR-TEN A (HR)	33,7	23,9	11,7	▲	*	80,5	*	*	55,7	*	*	*
3CR12 (Pickled)	0,186	0,192	0,114	▲	0,877	1,130	0,518	0,500	0,090	0,063	0,025	0,020
3CR12 (HR)	10,7	8,00	2,68	▲	19,7	15,1	6,36	3,38	10,2	4,77	2,27	1,23

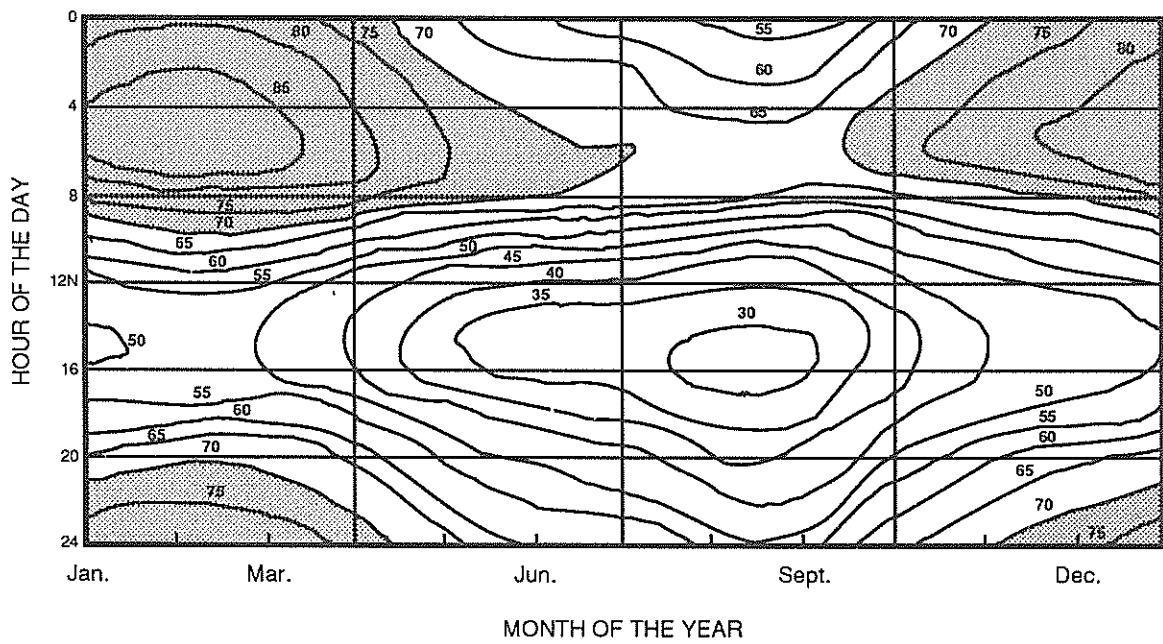
\* Incorrect alloy supplied, thus no sample available for corrosion rate determination

† Specimen holed thus corrosion rate determinations abandoned

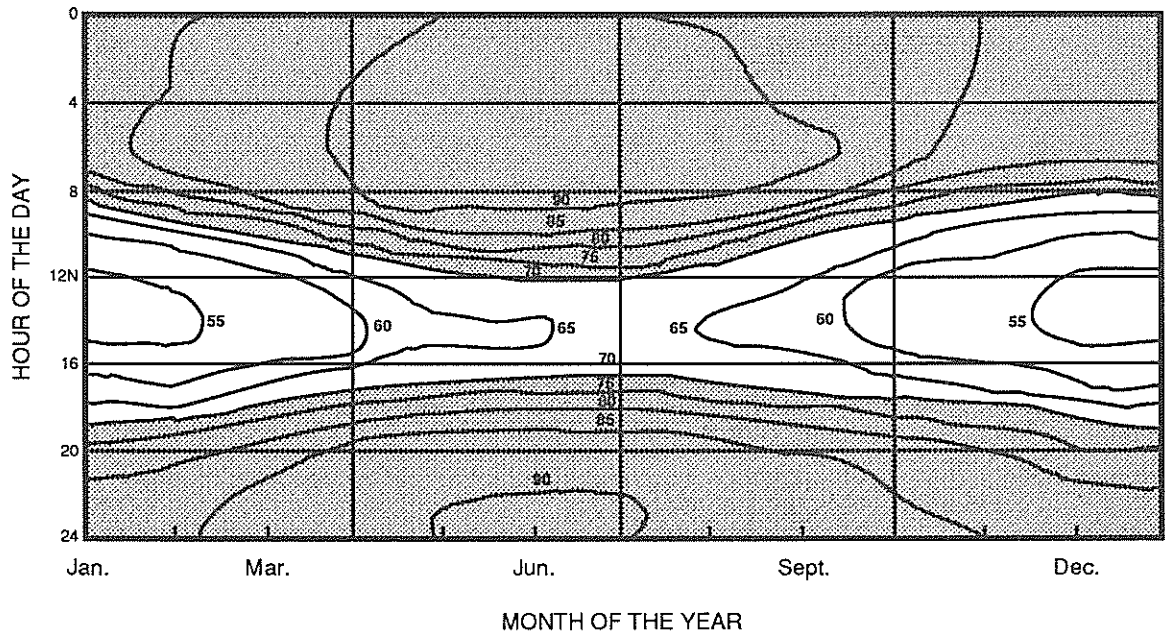
▲ Specimens stolen



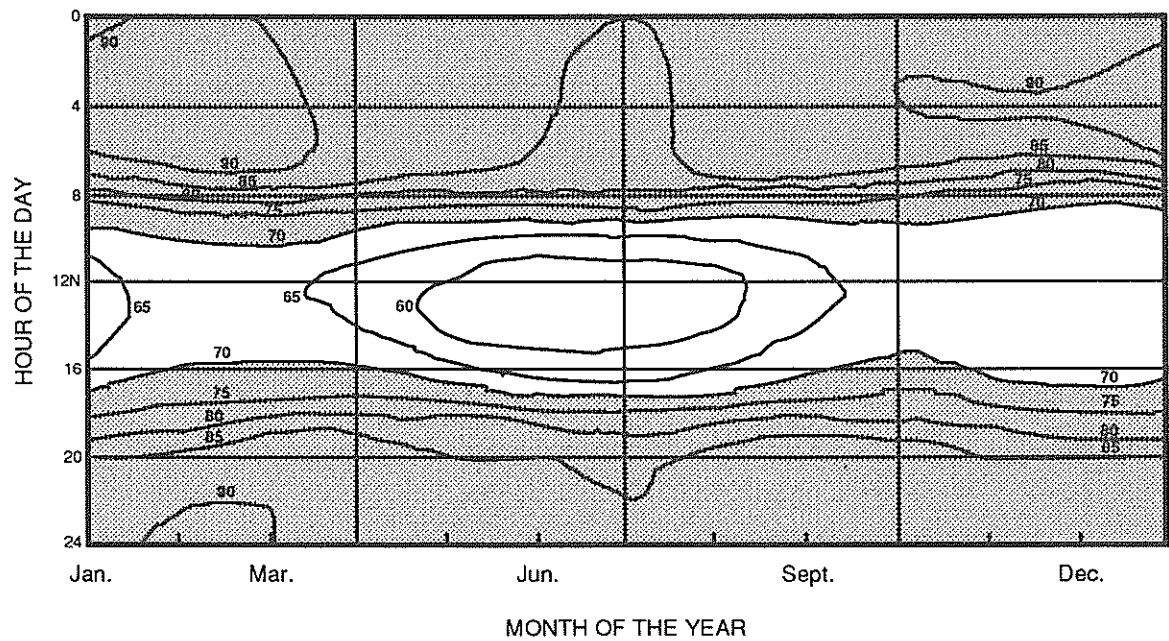
**FIGURE 1**  
 Schematic diagram illustrating effect of relative humidity on the corrosion of steel (pollutants absent)



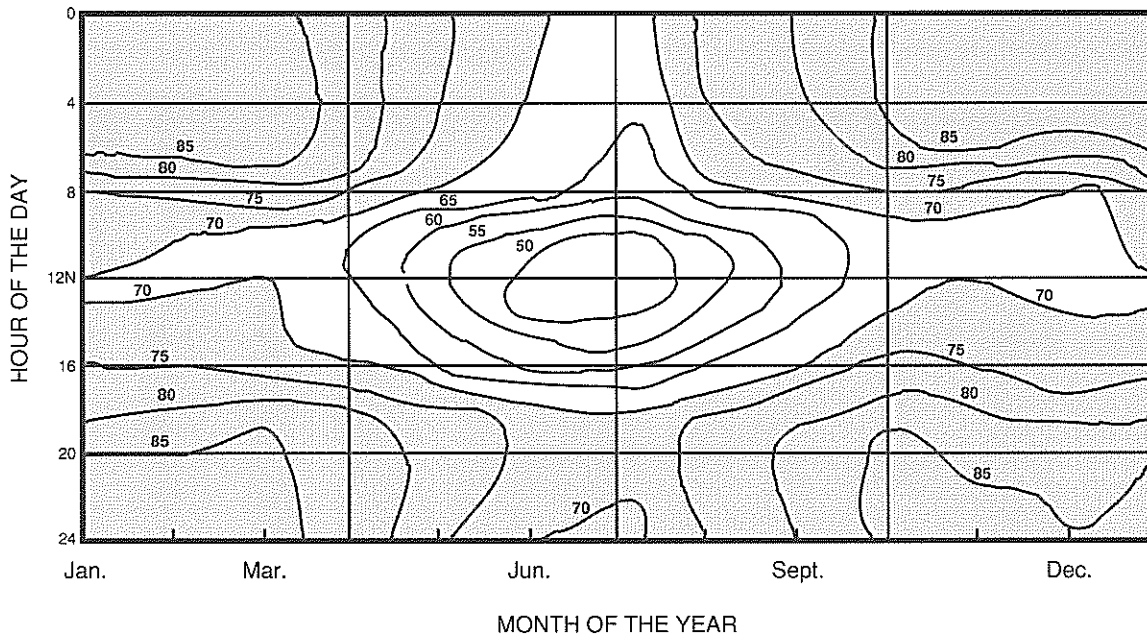
**FIGURE 2**  
 Relative Humidity Isogram for Jan Smuts Airport



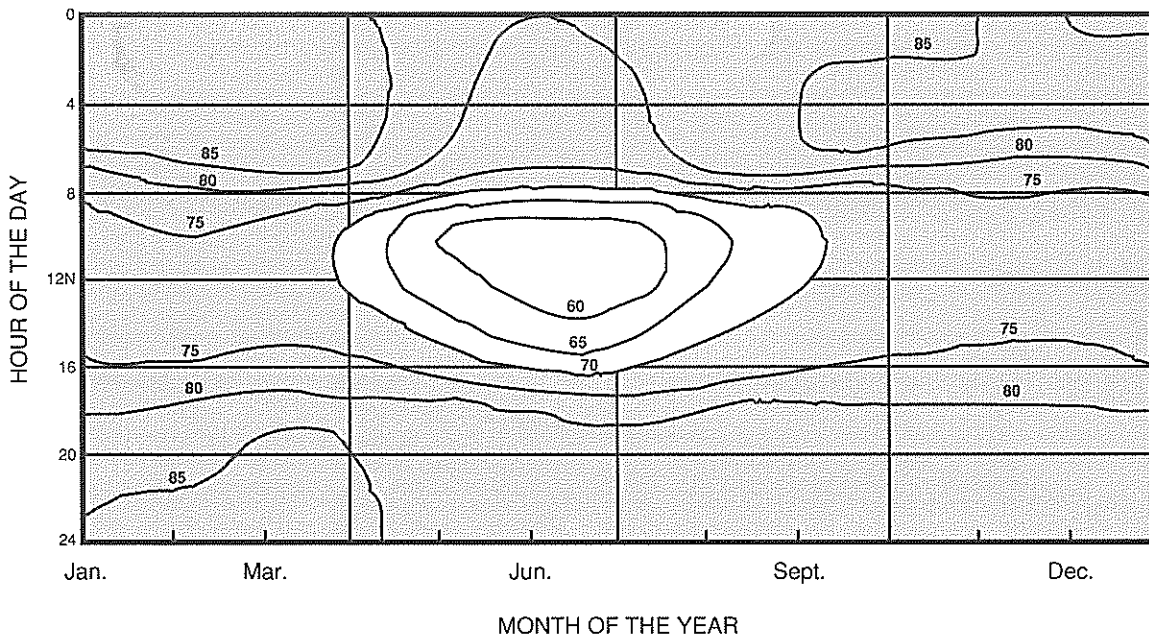
**FIGURE 3**  
**Relative Humidity Isogram for Cape Town**



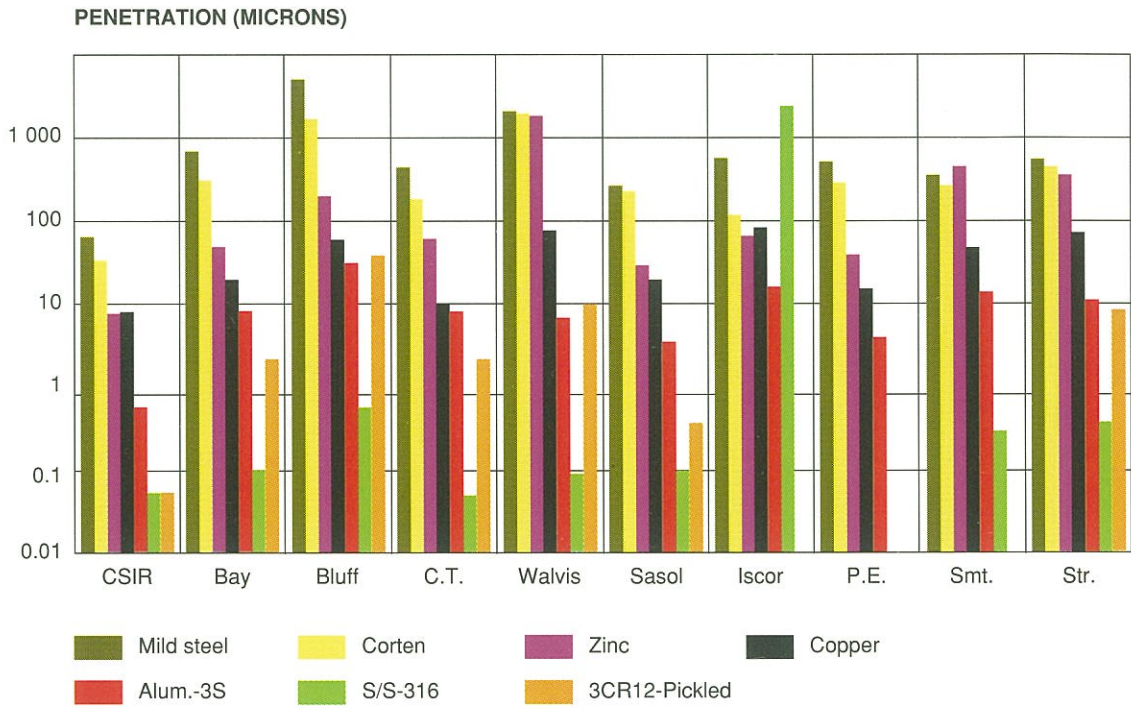
**FIGURE 4**  
**Relative Humidity Isogram for Port Elizabeth**



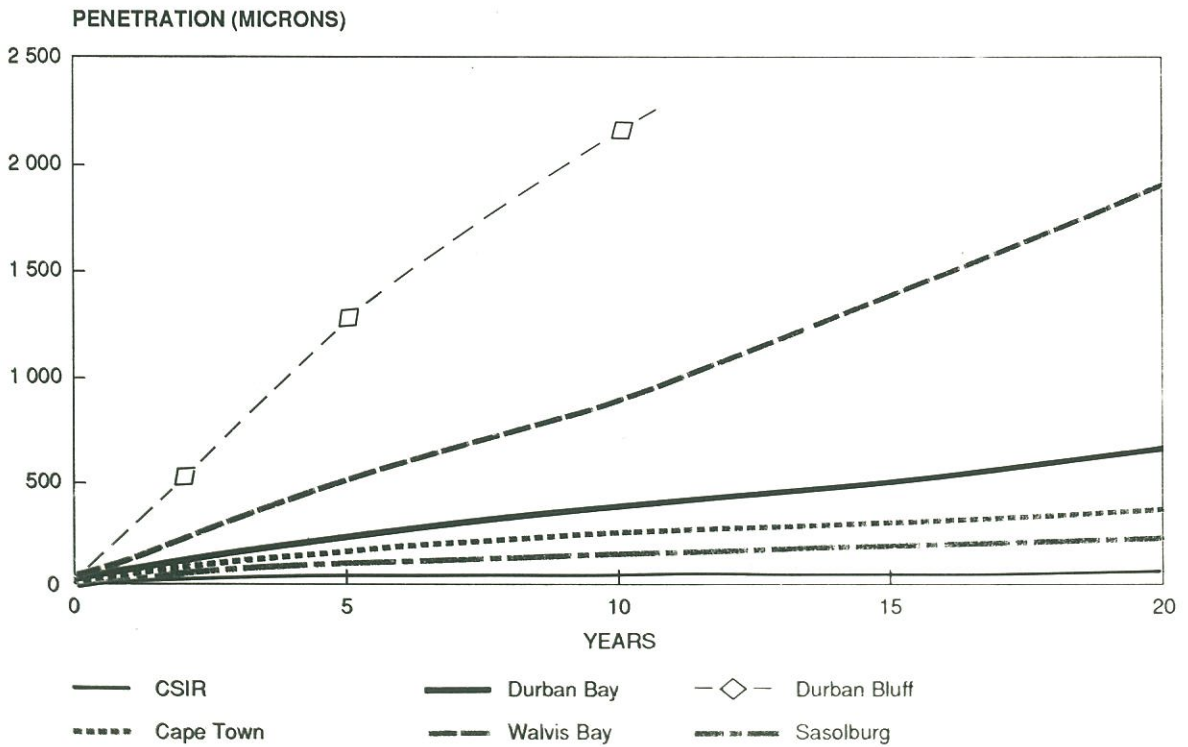
**FIGURE 5**  
**Relative Humidity Isogram for East London**



**FIGURE 6**  
**Relative Humidity Isogram for Durban**

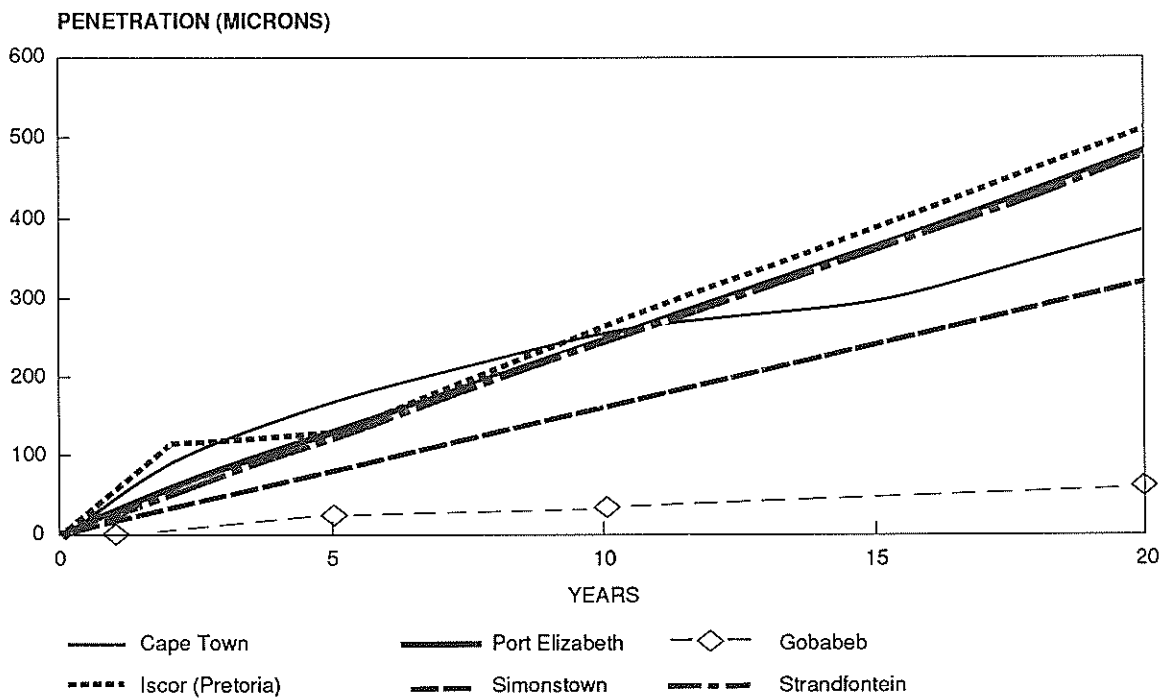


**FIGURE 7**  
20 years exposure – comparative results

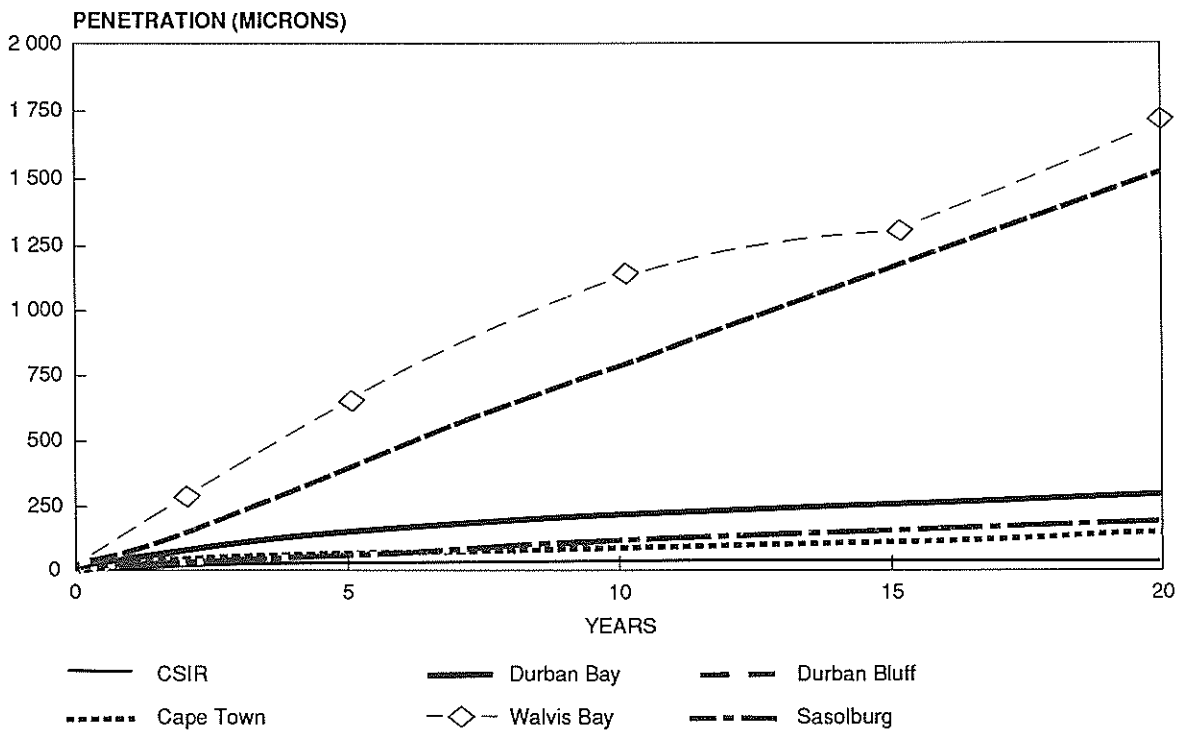


**FIGURE 8**  
20 year results for Mild Steel

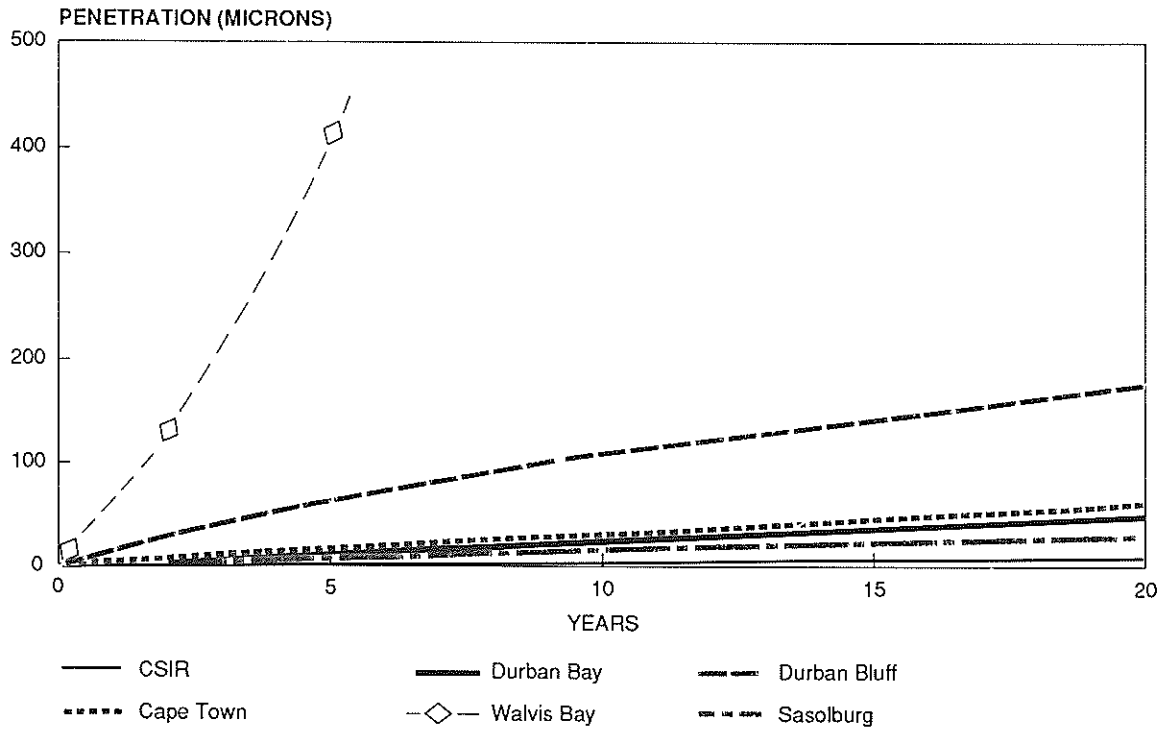
**FIGURE 9**  
**20 year results for Mild Steel (Less severe sites)**



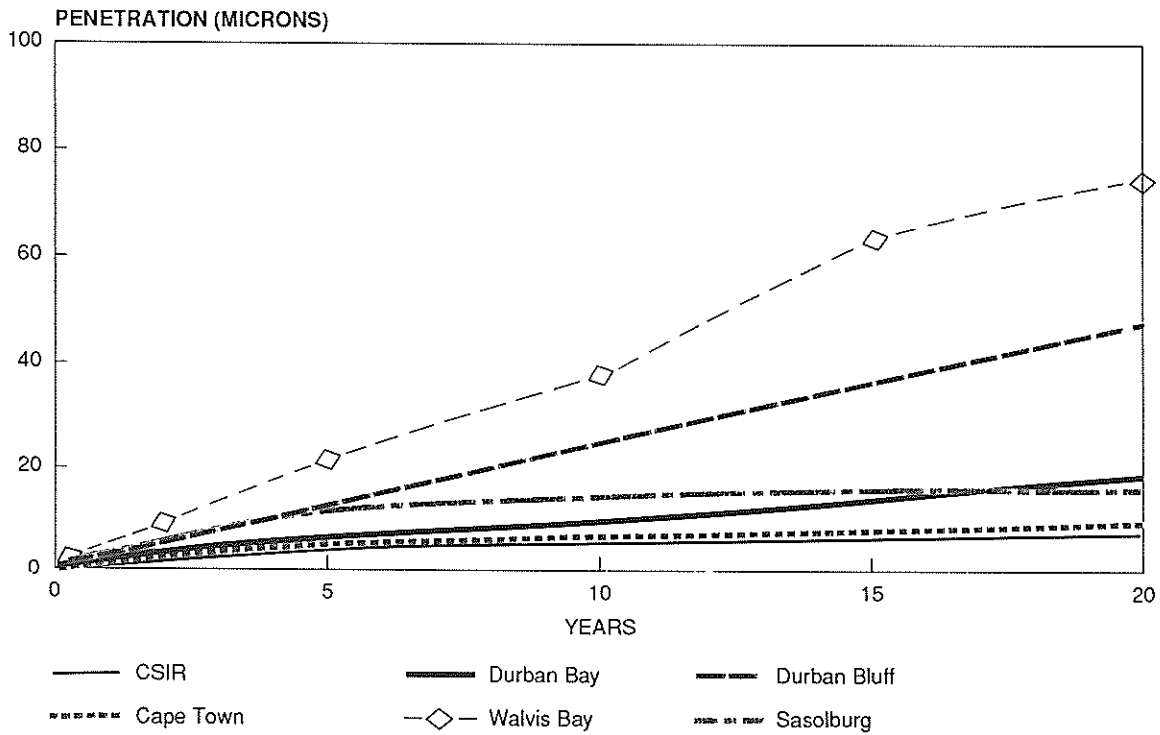
**FIGURE 10**  
**20 year results for Corten A**



**FIGURE 11**  
**20 year results for Zinc**



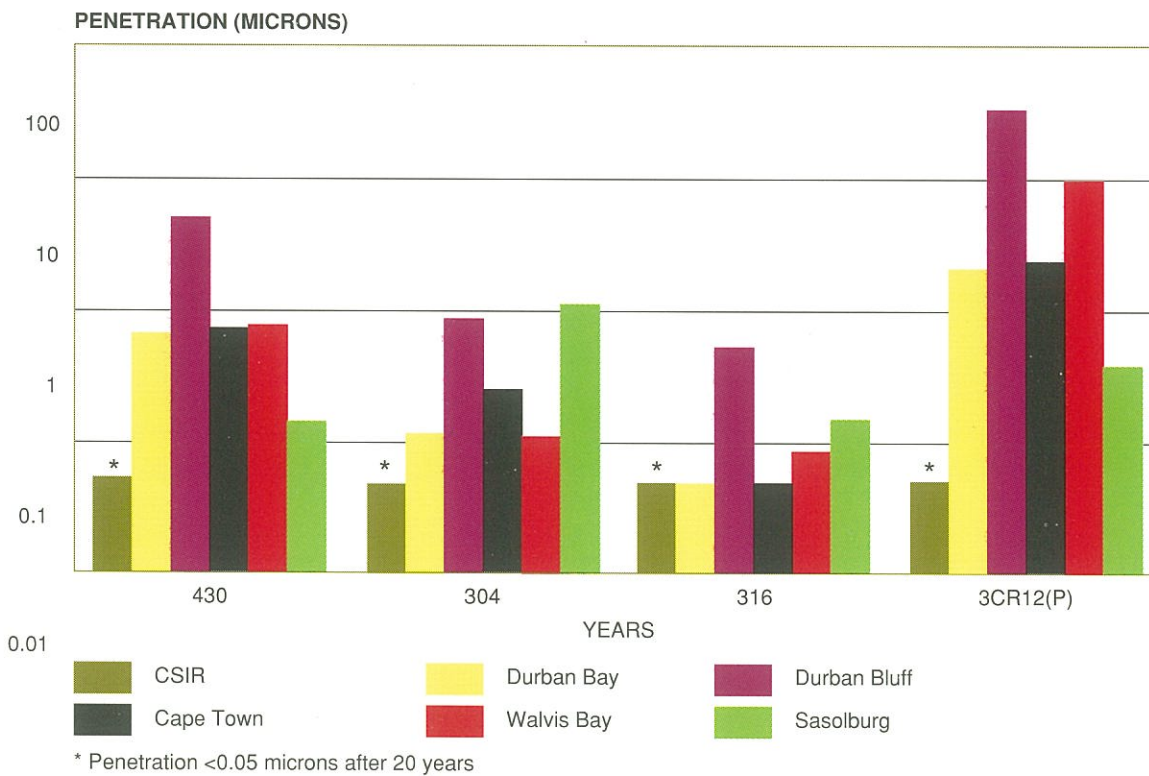
**FIGURE 12**  
**20 year results for Copper**







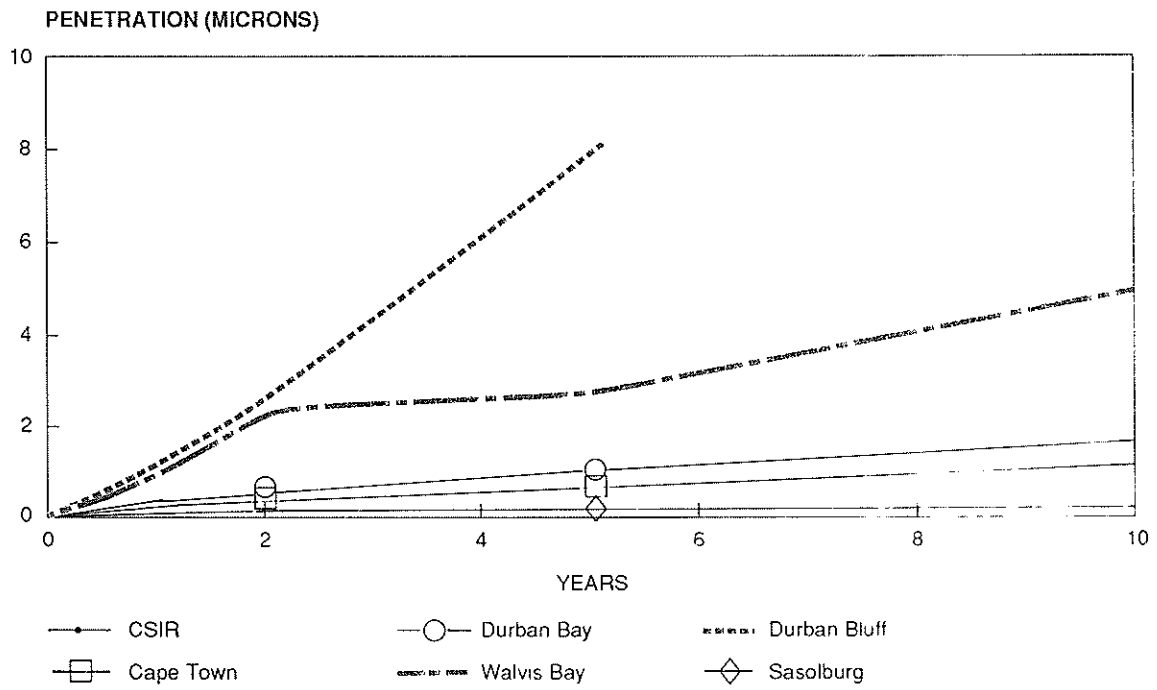
**FIGURE 13**  
20 year results for Aluminium

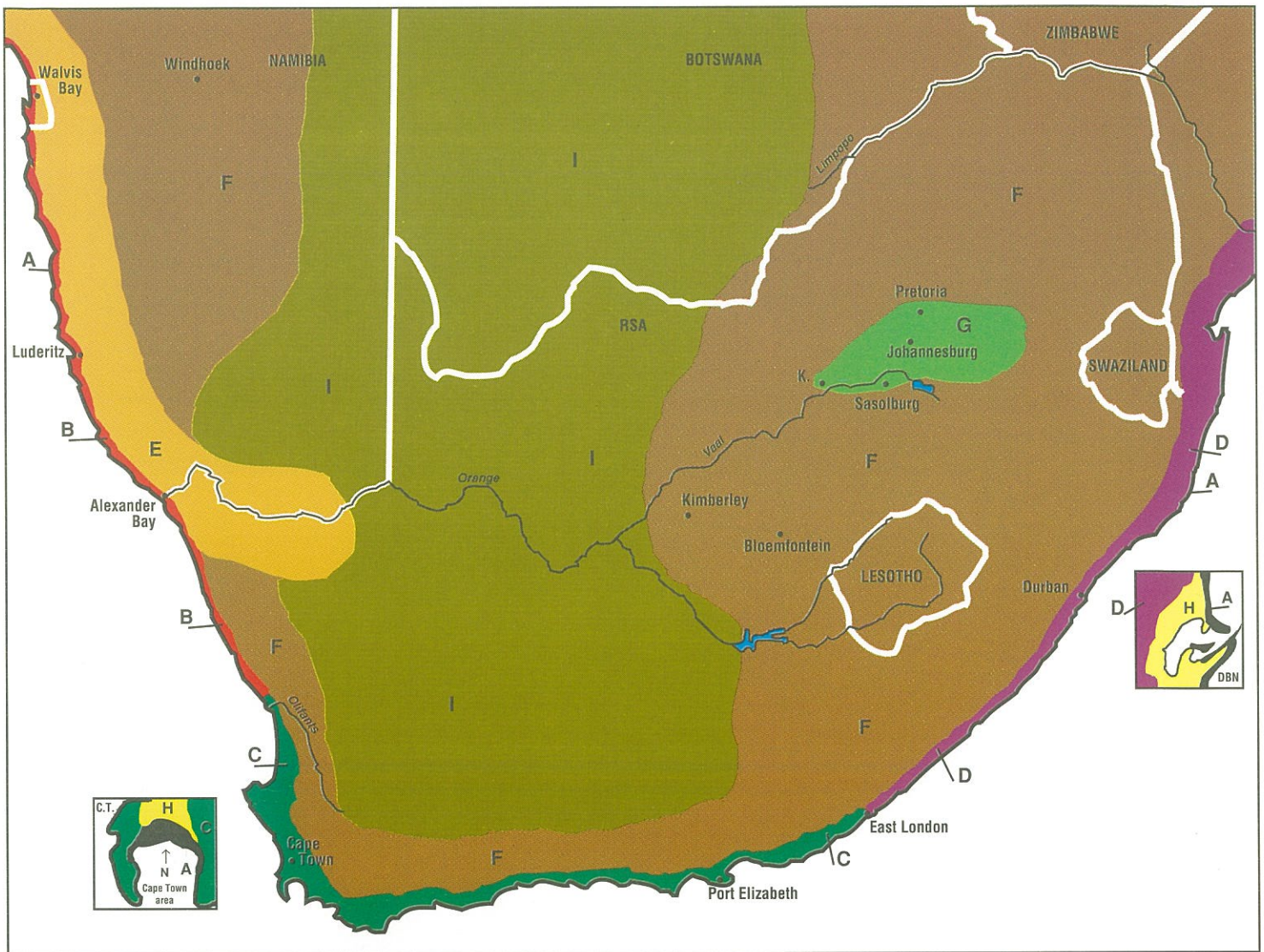


**FIGURE 14**  
20 year results for Stainless Steel










FIGURE 15

10 year results for 3CR12(P) (Second exposure programme)





**LEGEND**

Code	Description	Map identif.	Type of corrosion	Mild steel* corrosion rate $\mu\text{m}/\text{yr}$	Galvanised steel sheet** life in years†
A	Intertidal to 5 km inland		Severe marine	100 – 300	Up to 3
B	Desert marine (Mists)		Severe marine	80 – 100	0,5 – 2
C	Temperate marine		Marine	30 – 50	3 – 7
D	Sub-tropical marine		Medium to severe marine	50 – 80	3 – 5
E	Desert inland dry		Desert	< 5	> 30
F	Inland		Rural	10 – 20	> 20
G	Inland urban		Inland industrial††	15 – 40	5 – 15
H	Urban coastal		Marine industrial††	50 – 150	1 – 3
I	Inland arid		Semi desert	5 – 10	> 30

\* Higher corrosion rate usually indicates proximity of sea.

\*\* Commercial grade Z 275 g/m<sup>2</sup> (unpainted).

† Life in years – until 5% of surface area showing red rust.

†† Industrial implies pollution present in atmosphere.

C and D usually from 5 km inland up to first mountain range.

**FIGURE 16**  
**Atmospheric corrosion map of Southern Africa**

**PLATE 1: Mild Steel**



CSIR (20 years)



Sasol (20 years)



Bay Head (20 years)



Bluff (5 years)



Cape Town (5 years)



Strandfontein (2 years)

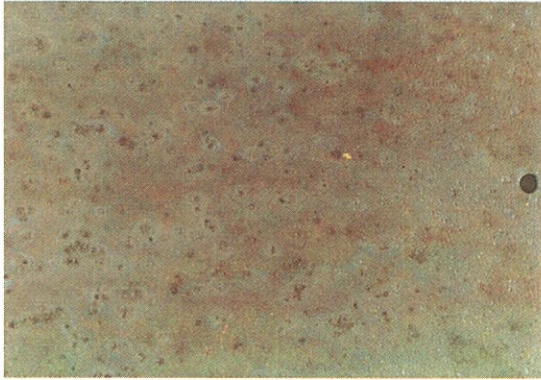


Port Elizabeth (5 years)

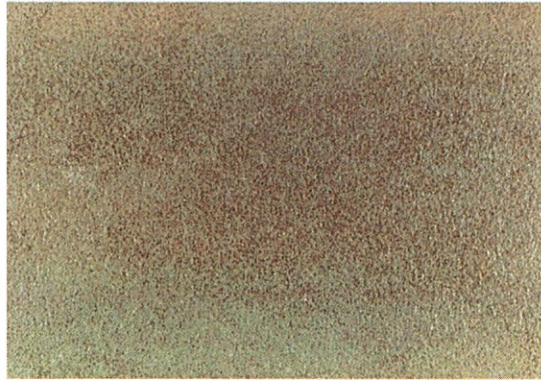


Walvis Bay (20 years)

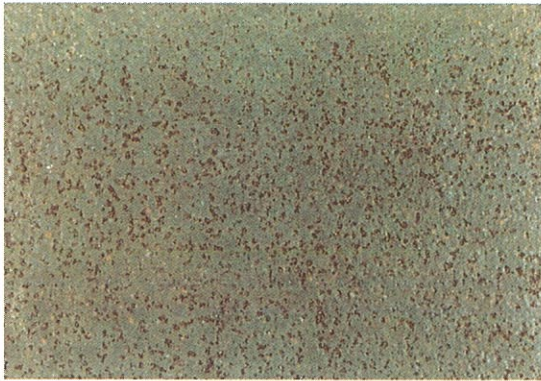
**PLATE 2: COR-TEN A**



CSIR (20 years)



Sasol (20 years)



Bay Head (20 years)



Bluff (15 years)



Cape Town (15 years)



Strandfontein (2 years)



Port Elizabeth (5 years)



Walvis Bay (20 years)

**PLATE 3: Zinc**



CSIR (20 years)



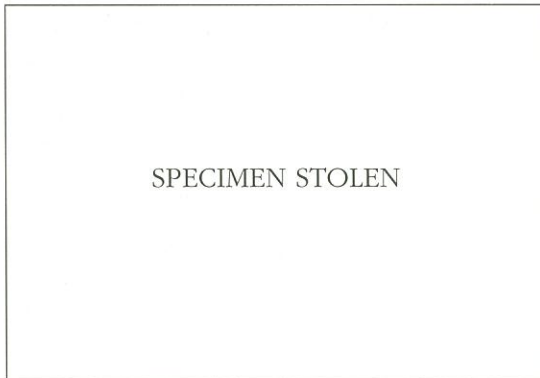
Sasol (20 years)



Bay Head (15 years)



Bluff (20 years)



Cape Town



Strandfontein (2 years)

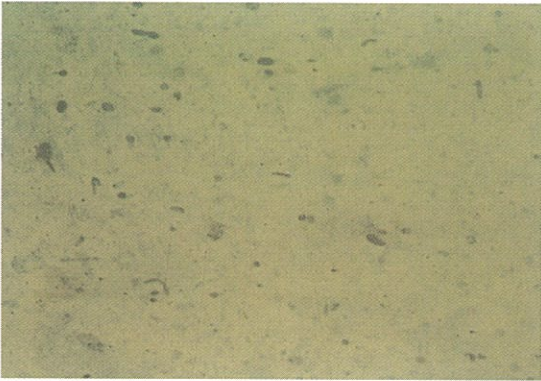


Port Elizabeth (10 years)

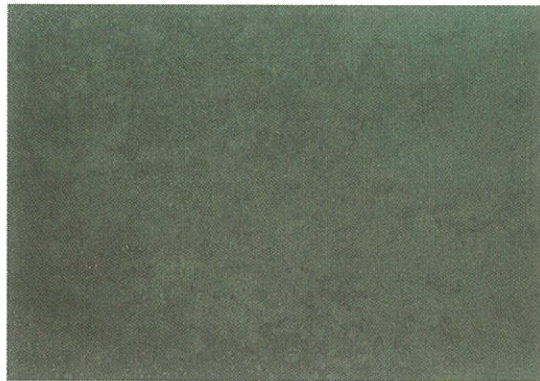


Walvis Bay (5 years)

**PLATE 4: Copper**



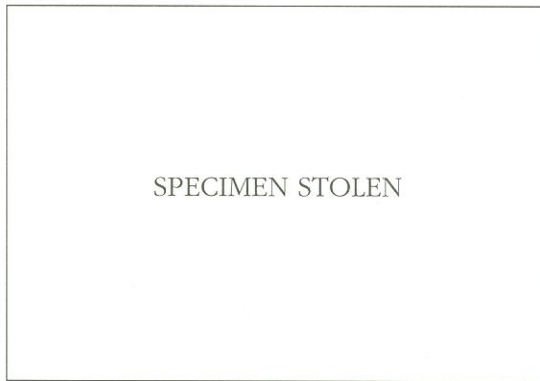
CSIR (20 years)



Sasol (20 years)



Bay Head (15 years)



Bluff



Cape Town (15 years)



Strandfontein (2 years)

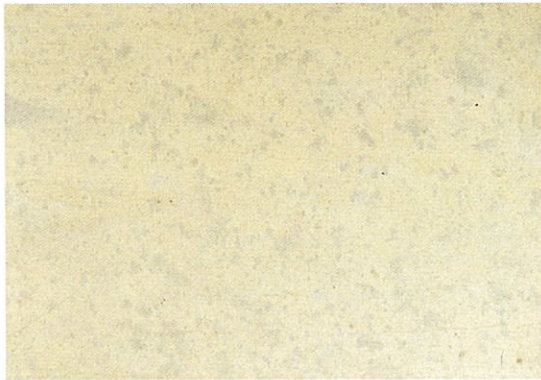


Port Elizabeth (10 years)



Walvis Bay (20 years)

**PLATE 5: 3S Aluminium**



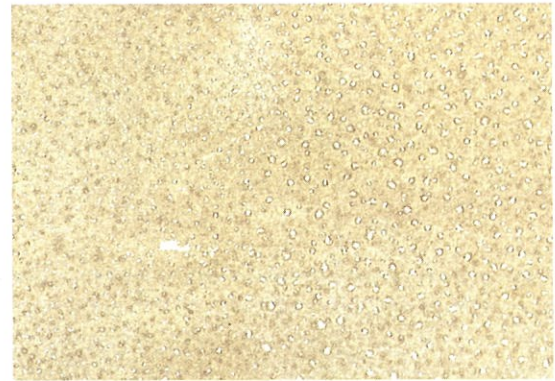
CSIR (20 years)



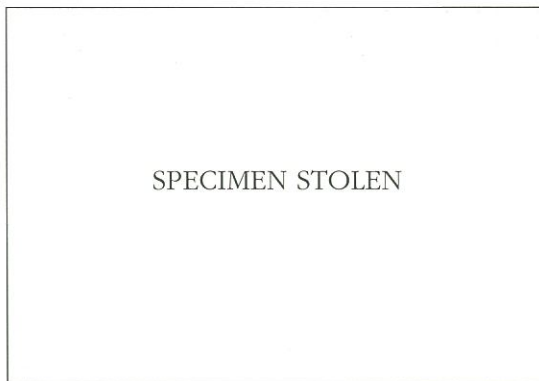
Sasol (20 years)



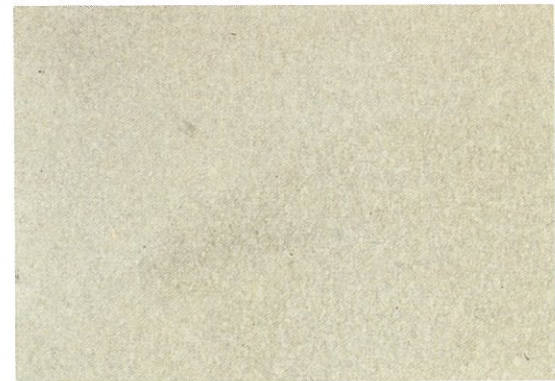
Bay Head (15 years)



Bluff (20 years)



Cape Town



Strandfontein (2 years)



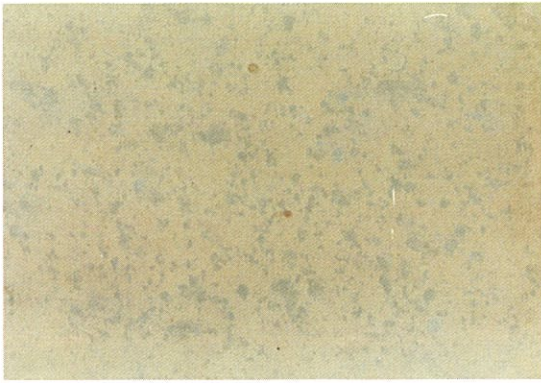
Port Elizabeth (10 years)



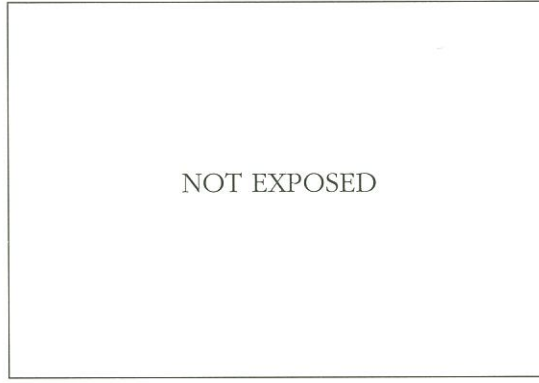
Walvis Bay (20 years)



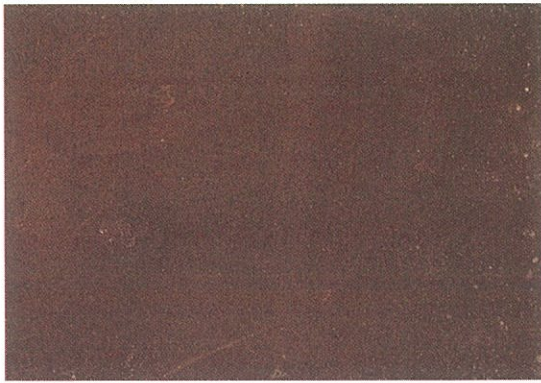
**PLATE 6: M57S Aluminium**



CSIR (20 years)



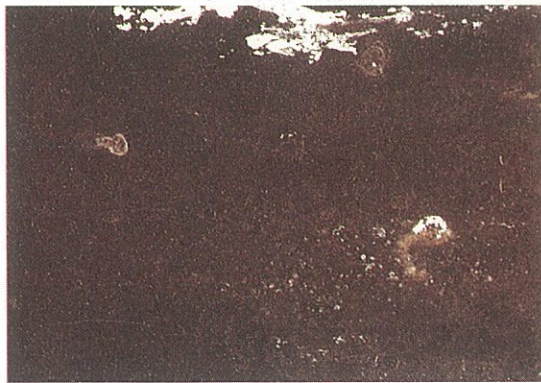
Sasol



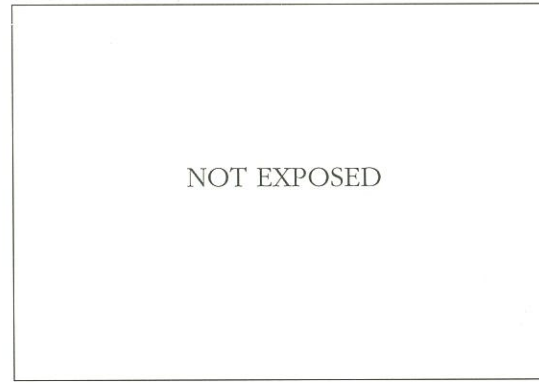
Bay Head (15 years)



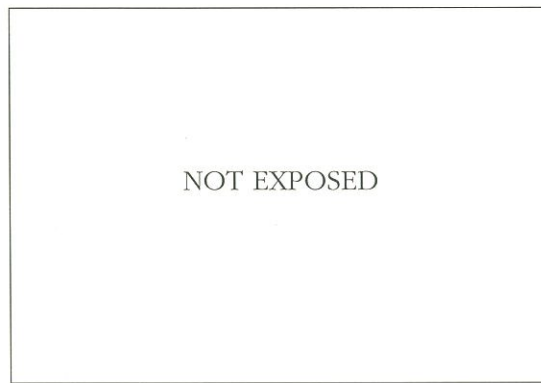
Bluff (20 years)



Cape Town (15 years)



Strandfontein



Port Elizabeth

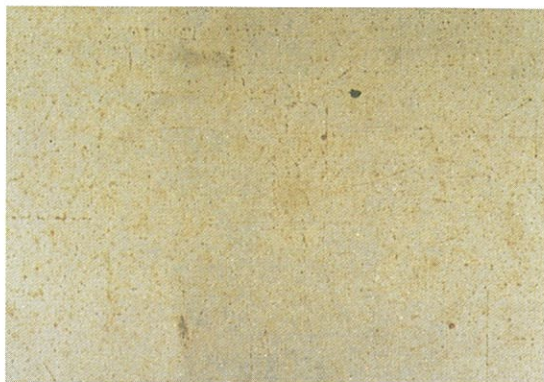


Walvis Bay (20 years)

**PLATE 7: AISI 430 Stainless Steel**



CSIR (20 years)



Sasol (20 years)



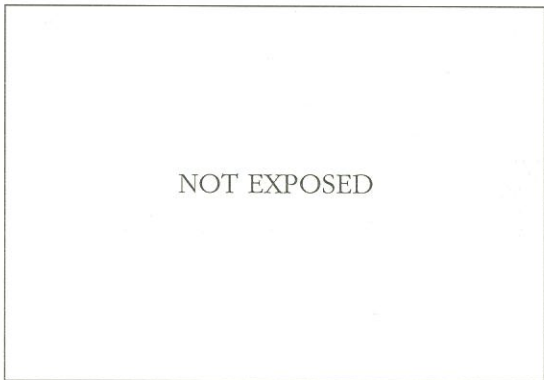
Bay Head (20 years)



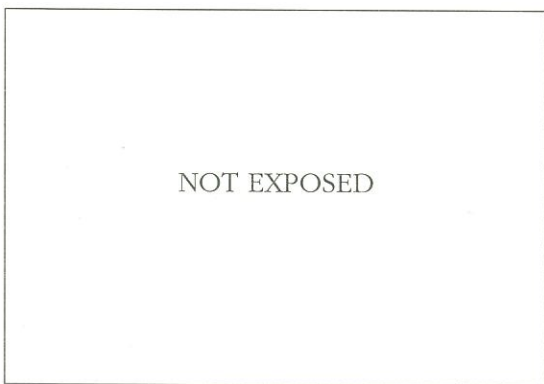
Bluff (20 years)



Cape Town (15 years)



Strandfontein

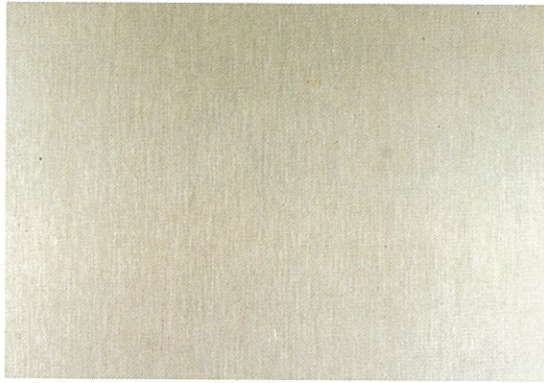


Port Elizabeth

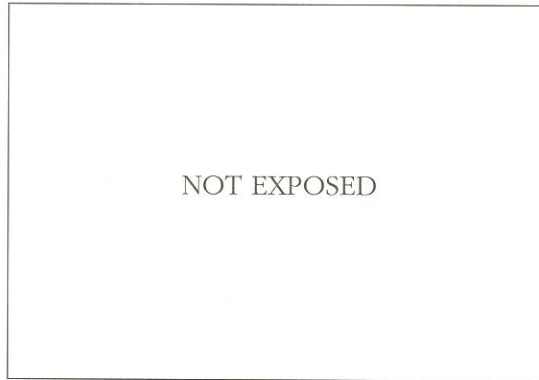


Walvis Bay (20 years)

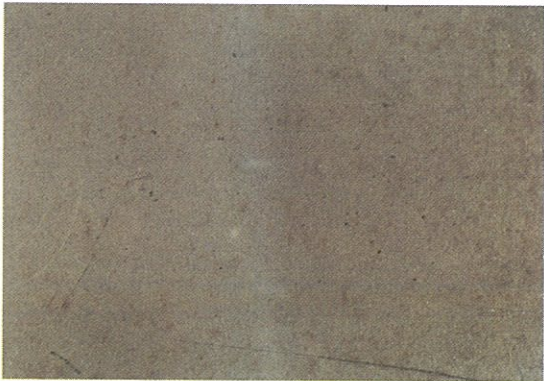
**PLATE 8: AISI 304 Stainless Steel**



CSIR (20 years)



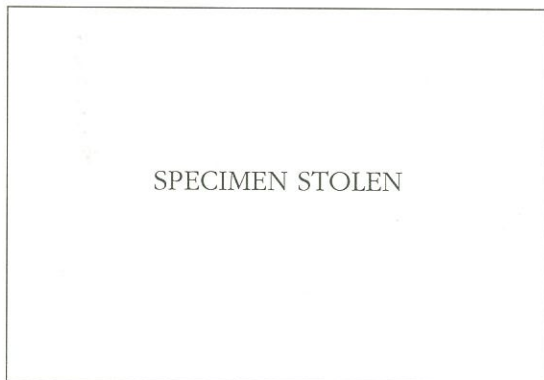
Sasol



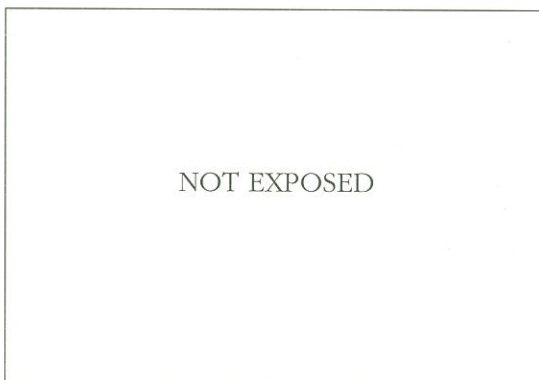
Bay Head (15 years)



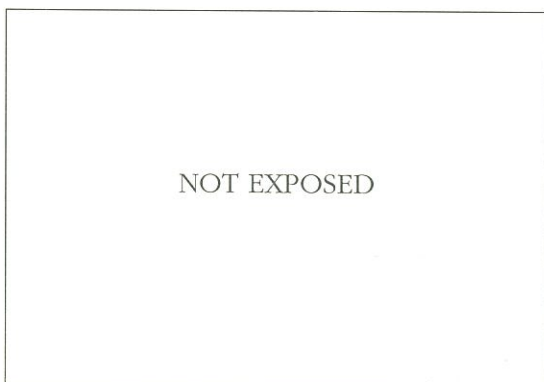
Bluff (20 years)



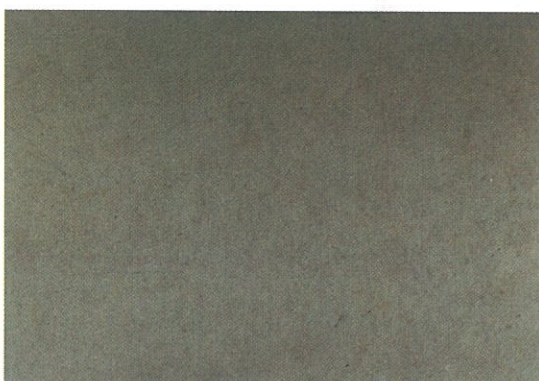
Cape Town



Strandfontein

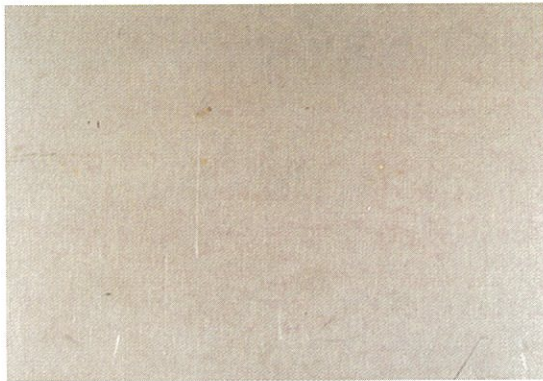


Port Elizabeth

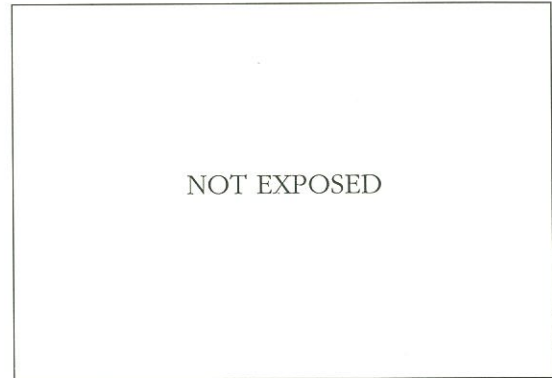


Walvis Bay (20 years)

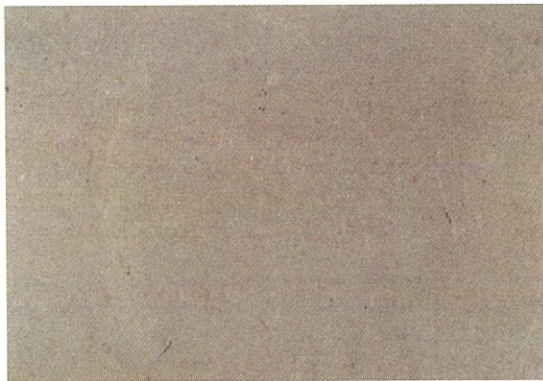
**PLATE 9: AISI 316 Stainless Steel**



CSIR (20 years)



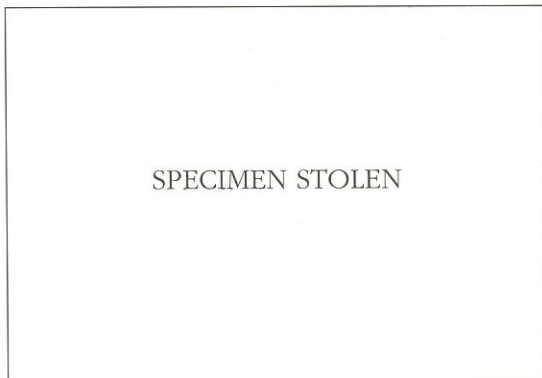
Sasol



Bay Head (15 years)



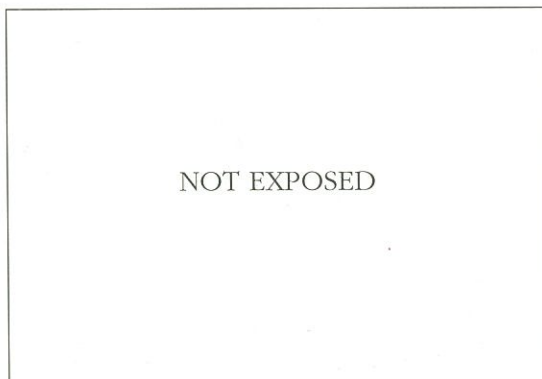
Bluff (20 years)



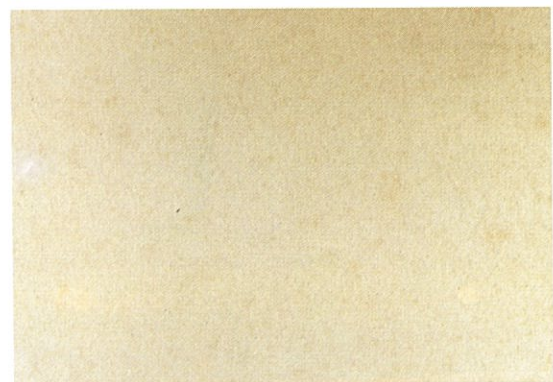
Cape Town



Strandfontein (2 years)



Port Elizabeth

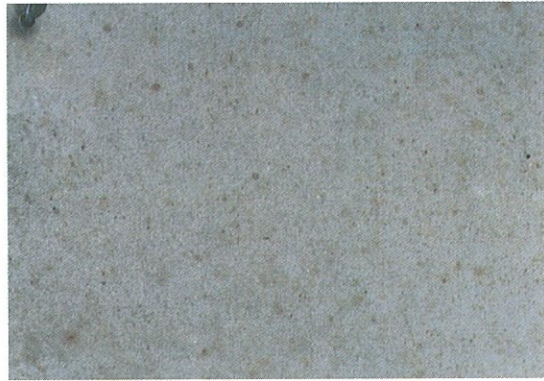


Walvis Bay (20 years)

**PLATE 10: 3CR12 Alloy – pickled and passivated**



CSIR (10 years)



Sasol (10 years)



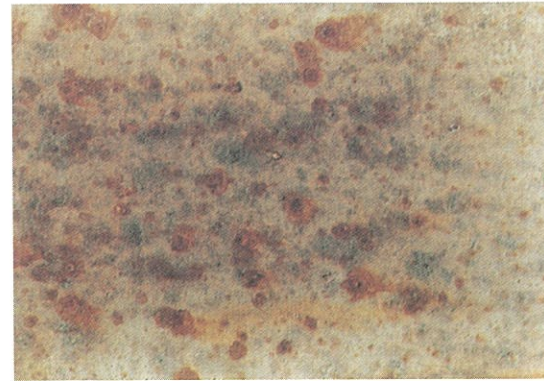
Bay Head (10 years)



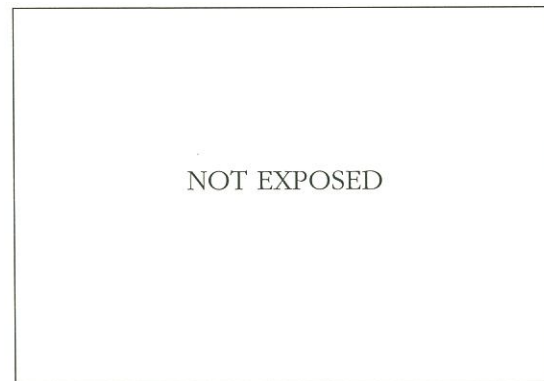
Bluff (10 years)



Cape Town (5 years)



Strandfontein (2 years)

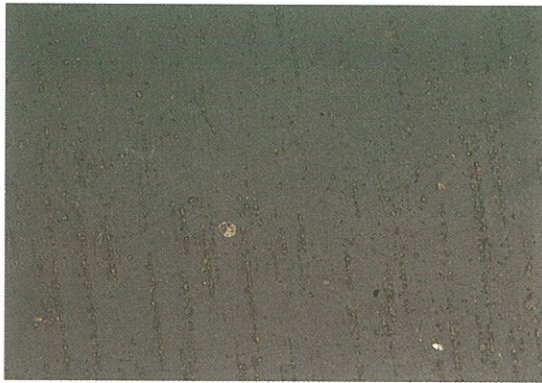


Port Elizabeth

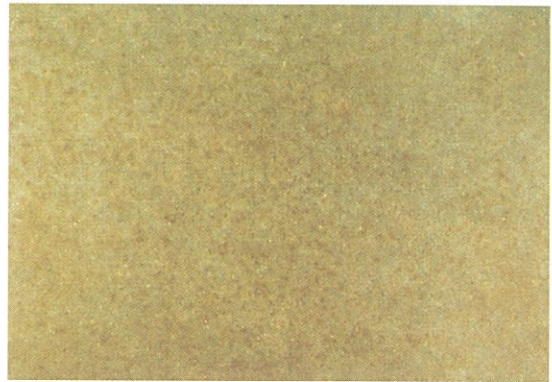


Walvis Bay (10 years)

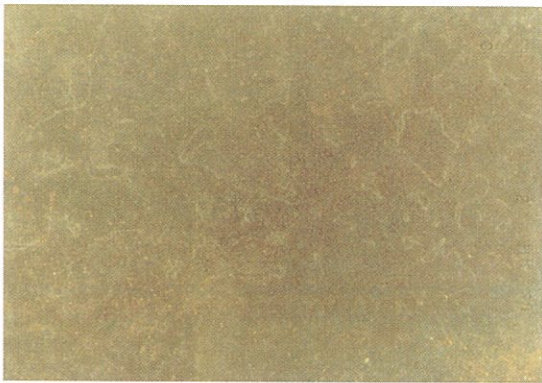
**PLATE 11: 3CR12 Alloy – hot rolled condition**



CSIR (10 years)



Sasol (10 years)



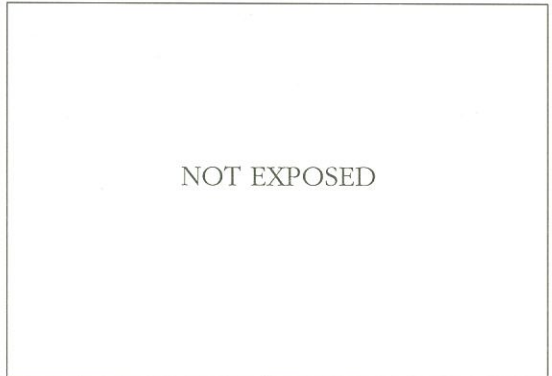
Bay Head (10 years)



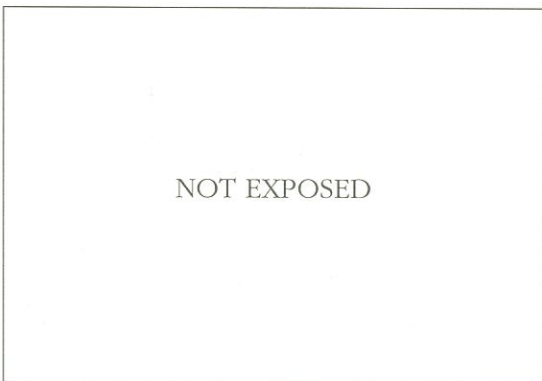
Bluff (10 years)



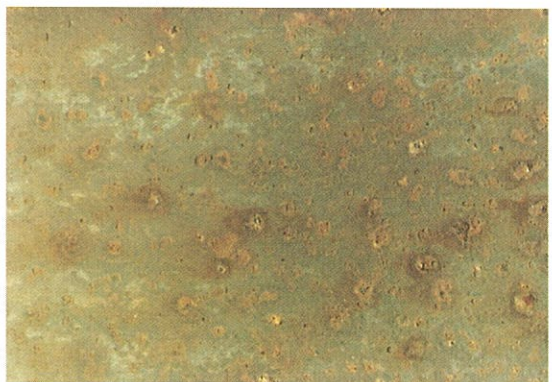
Cape Town (5 years)



Strandfontein



Port Elizabeth

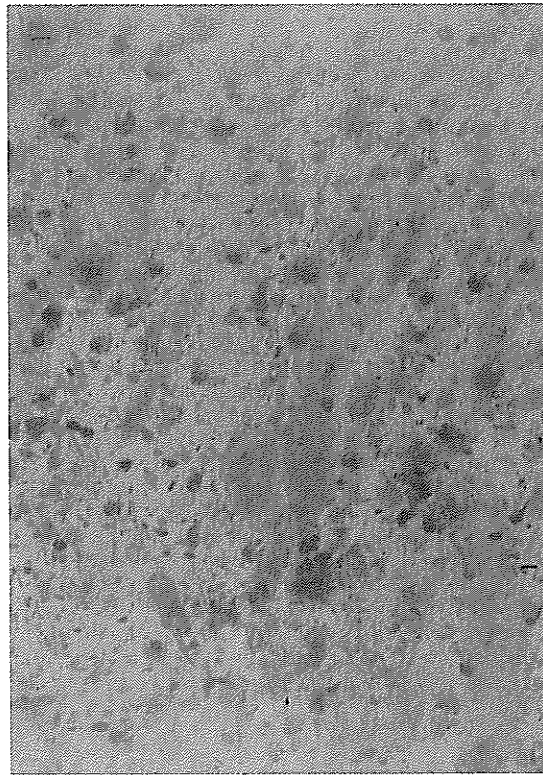


Walvis Bay (10 years)

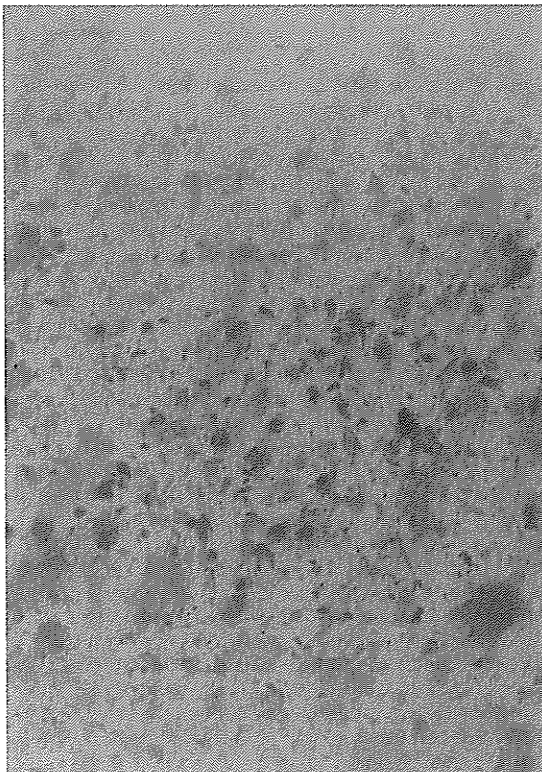
**PLATE 12(a): Anodised Aluminium – 20 years exposure at CSIR**



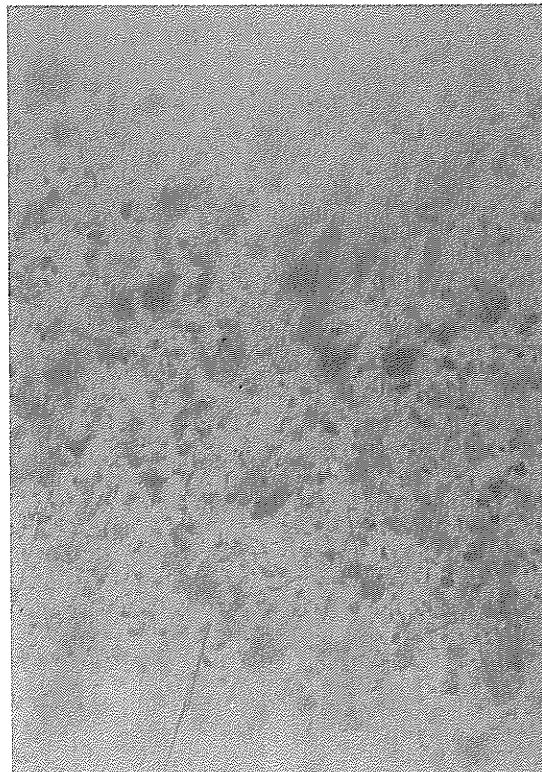
5 µm



15 µm

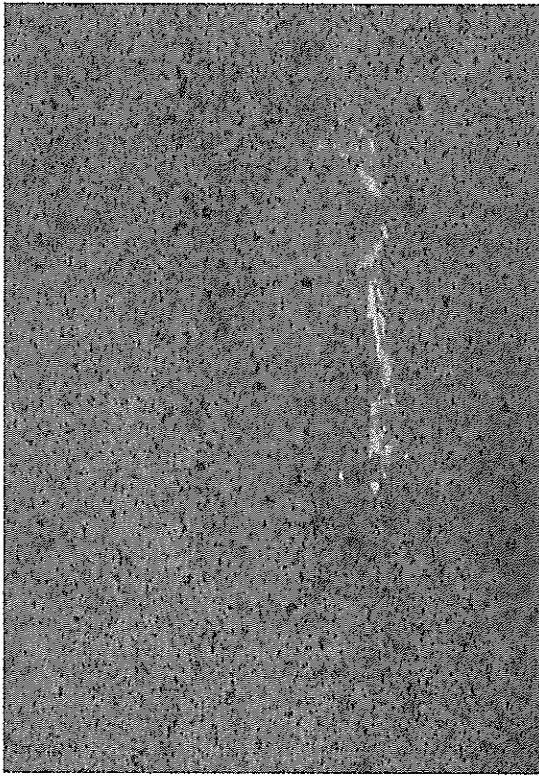


20 µm

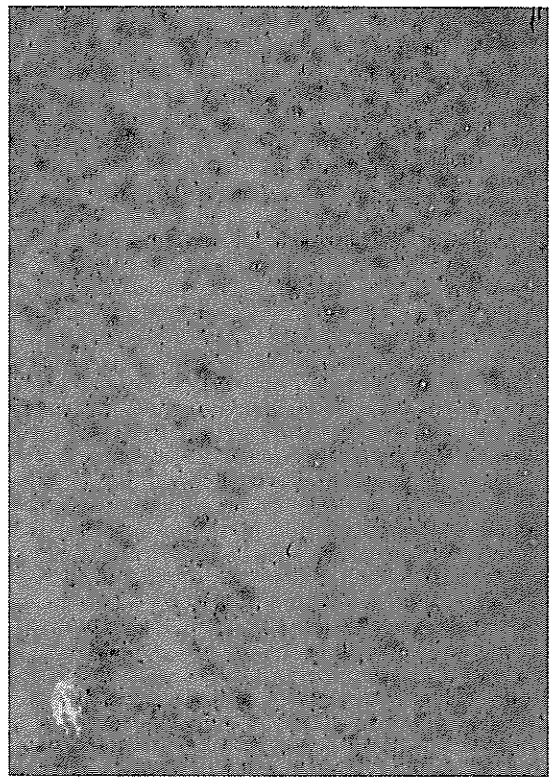


25 µm

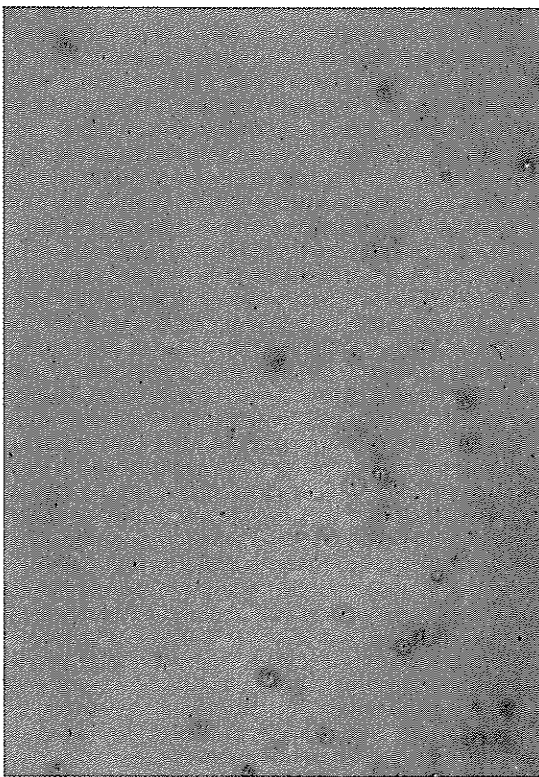
**PLATE 12(b): Anodised Aluminium – 20 years exposure at Durban Bluff**



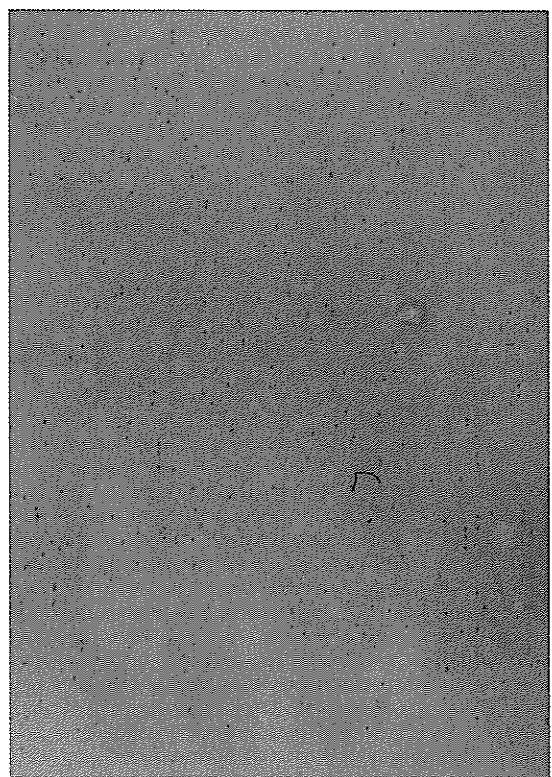
5 µm



15 µm



20 µm



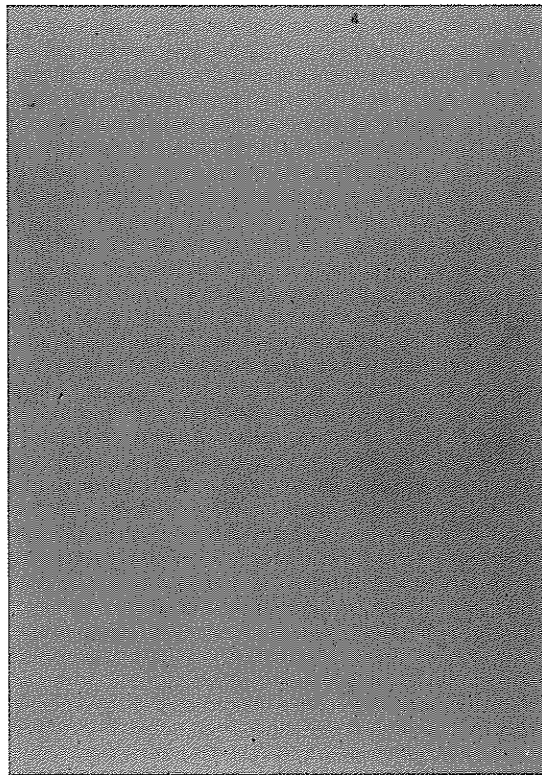
25 µm



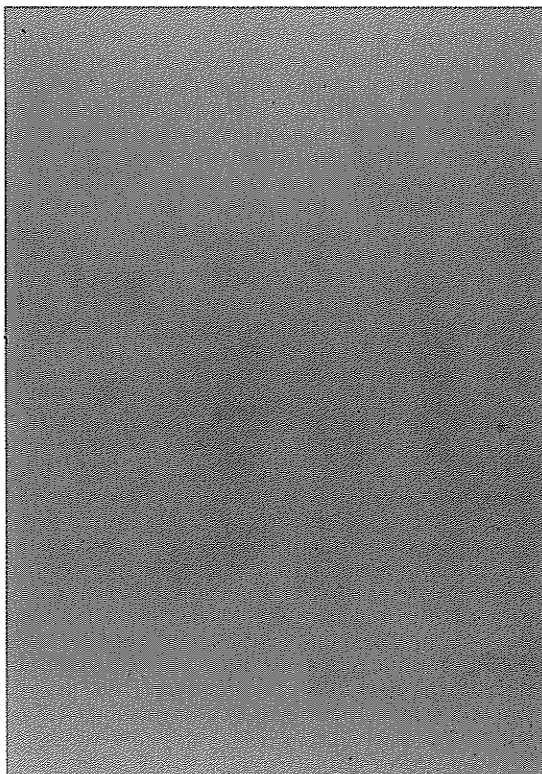
**PLATE 12(c): Anodised Aluminium – 20 years exposure at Walvis Bay**



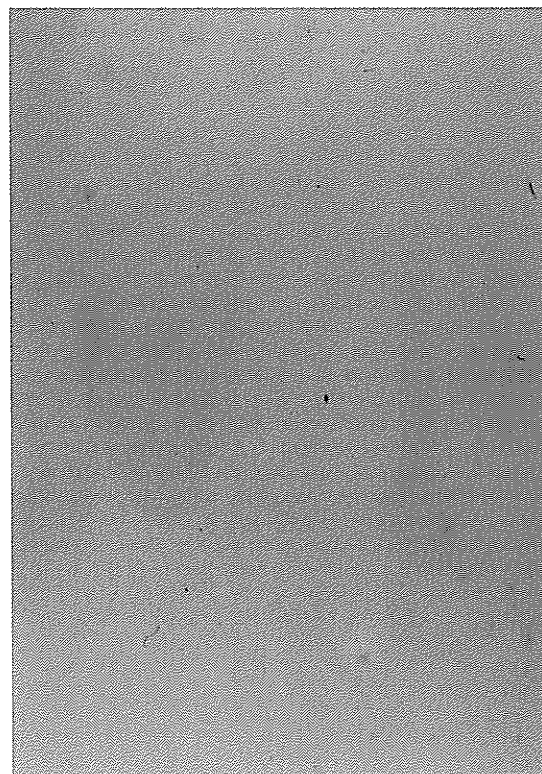
5 µm



15 µm



20 µm



25 µm

**PLATE 13: Thermally Sprayed Aluminium applied to steel  
25 years exposure at Walvis Bay (100  $\mu\text{m}$  thickness, unsealed)**



## **ACKNOWLEDGEMENTS**

The following companies contributed to the exposure programme by providing certain metals and alloys initially:

- Alusaf (Pty) Limited
- Hulett Aluminium Limited
- Middelburg Steel and Alloys (Pty) Limited

Assistance in the provision of site facilities was provided by:

- South African Defence Force
- South African Railways
- City Engineer – Cape Town
- City Engineer – Durban
- Sasol One
- University of Port Elizabeth
- Union Whaling Company

I wish to acknowledge the assistance received from many colleagues within the CSIR over the many years that this exposure programme was carried out; also to thank the CSIR for permission to publish this work and to Dr Colin Boothroyd for his active encouragement to have the final results published. Thanks to Keith Rodseth for his assistance with graphs and for proofreading.

I would also like to thank my wife, Pat, and children, Hilary, Peter and Brenda for their understanding and patience over the years when I was away from home pursuing one of my hobbies – atmospheric corrosion!

## REFERENCES

- 1) Sereda, P J: ASTM Bulletin No. 246, p. 47, May (1960).
- 2) Sereda, P J: ASTM Special Techn. Publ. 558, p. 7, June (1973).
- 3) Vernon, W H J: Trans. Faraday Soc. Vol. 27, p. 265, (1931).
- 4) Vernon, W H J: Trans. Faraday Soc. Vol. 31, p. 1668, (1935).
- 5) Schikorr, G: Arch. Metallk., 2, p. 223, (1948).
- 6) Schikorr, G: Arch. Metallk., 3, p. 76, (1949).
- 7) Hudson, J C and Stanners, J F: J. Appl. Chem., 3, 86, (1953).
- 8) Barton, K, Beranek, E and Akimov, G: Werkstoffe u Korrosion, Vol. 10, No. 6, (1959).
- 9) Sereda, P J: Ind. Eng. Chem., Vol. 52, No. 2, (1960).
- 10) Ross, T K and Callaghan, B G: Corrosion Science, Vol. 6, (1966).
- 11) Ross, T K and Callaghan, B G: Nature, Vol. 211, No. 5044, (1966).
- 12) Scott, W D and Hobbs, P V: J. Atm. Sci., Vol. 24, No. 1, (1967).
- 13) Copenhagen, W J: Chem. and Ind. p. 313, (1952).
- 14) Guttman, H and Sereda, P J: ASTM, STP 435, p. 326, (1968).
- 15) Guttman, H: ASTM, STP 435, p. 223, (1968).
- 16) Callaghan, B G: "Atmospheric Corrosion", Ed. W H Ailor, Chapter 61, John Wiley and Sons (1982).
- 17) Schauder, R: SA Mining and Eng. J., January (1947).
- 18) Copenhagen W J: Public Works of SA, May (1954).
- 19) Godard, H P: Archit. Build., 4, 54, (1954).
- 20) Godard, H P: Archit. Build., 8, 70, (1958).
- 21) Godard, H P: Archit. Build., 12, 32, (1962).
- 22) Godard, H P and Ferguson: Archit. Build., 23, (1973).
- 23) Booth, F F: SA Corr. J., 2 (4), (1966).
- 24) Doyle, D P and Godard, H P: Corr. Met. Fin. (SA), 1 (2), 10, (1964).
- 25) Doyle, D P and Godard, H P: Corr. Met. Fin. (SA), 1 (10), 8, (1964).
- 26) Callaghan, B G: Corrosion and Coatings SA. Vol. 7, No. 3 (1980).
- 27) Joseph, R M H and Patrick, G W: Met. Fabric. Fin. Prot., Jan/Feb (1971).
- 28) McRae, I: Electricity Generation and Supply in SA, VGB Conference SA, November (1988).
- 29) Tyson, P D, Kruger, F J and Louw, C W: "Atmospheric Pollution and its Implications in the Eastern Transvaal Highveld. South African National Scientific Programmes Report No. 150, April (1988).
- 30) Callaghan, B G: J. Oil. Col. Chem. Assoc., 61, 411, (1978).
- 31) Callaghan, B G: Corrosion and Coating SA, Vol. 10, No. 2 (1983).
- 32) S A Weather Bureau: Climate of South Africa – Climate Statistics up to 1984, WB40, SA Weather Bureau, Dept. of Environmental Affairs, (1986).
- 33) Kemeney, E and Halliday, E C: CSIR Special Report APRG/73/9, Sept. (1973).
- 34) Kemeney, E and Halliday, E C: CSIR Special Report APRG/75/15, Oct. (1975).
- 35) Kemeney, E: CSIR Special Report APRG/77/3, Feb. (1977).
- 36) Kemeney, E: CSIR Special Report APRG/79/12, Sept. (1979).
- 37) Kemeney, E: CSIR Special Report ATMOS/81/10, Oct. (1981).
- 38) Kemeney, E and Vlegaar, C M: CSIR Special Report ATMOS/83/6, March (1983).
- 39) Kemeney, E, Walker, N and Ellerbeck, R: CSIR Special Report ATMOS/84/25, Dec. (1984).
- 40) Walker, N: Ellerbeck R and Marinus, N: CSIR Special Report ATMOS/87/13, March (1987).
- 41) Marinus, N: Ellerbeck R and Vlegaar, C M: CSIR Report, EMA-C 8933, Feb. (1989).
- 42) Ellerbeck, R, Marinus, N and Oosthuizen, M A: CSIR Report, EMA-C9020, Feb. (1990).
- 43) SABS: SABS 064, "Code of Practice for the Preparation of Steel Surfaces for coating" (1979).



### DESIRABLE DESIGN FEATURES

As has been indicated in the text, the results of atmospheric exposure testing cannot be used in isolation. Even the best materials will fail when used incorrectly. The following information is extracted from Appendix A - Good Structural Design Practice for Corrosion Prevention – which forms a part of SABS 0120: Part 3, Section HC-1988. "Corrosion Protection of Structural Steelwork". Although most of these comments have particular reference to structural steel, they do apply to most metal systems.

#### A.1 Structural aspects

The design of a structure may influence the choice of protective systems or material of construction. It may be appropriate and economical to modify the design to suit the selected system(s). The following points should be borne in mind:

- a) Easy access for corrosion protection and maintenance work should be provided. Certain areas may, after erection, be inaccessible for maintenance and so may require a coating system or material to last for the design life of the structure.
- b) Wherever possible, pockets, recesses and crevices in which water and dirt may collect should be avoided or properly drained.
- c) Wet operating conditions should be specifically catered for by the provision of an adequate drainage system.
- d) Some structural sections may be more suited to some coating systems than others, e.g. rods and hollow sections can be more easily wrapped than can structural shapes; lipped cold-rolled channels present problems and preference should be given to the use of Z-sections.
- e) The method or size of fabrication may preclude or limit some coating systems. Where coating by dipping is employed, adequate drainage holes must be provided. This will also avoid air pockets.
- f) In severely corrosive conditions, sharp edges must be reduced.
- g) Intermittent welding should be considered in the light of A.2.3 below.
- h) If materials are chosen which may cause bimetallic corrosion problems, additional attention must be given to design considerations, particularly in wet corrosive conditions (refer to BSI Publication PD 6484 "Commentary on corrosion at bimetallic contacts and its alleviation"). The effect of contact with other building materials should also be considered, e.g. aluminium and zinc in contact with concrete. Both zinc and aluminium are corroded by highly alkaline materials, thus the alkalinity of concrete, or leachings from concrete, can attack these two metals.
- i) Where necessary, sling points for handling, processing and transport purposes may be required.

## **A.2 Connections**

### **A.2.1 Friction-grip Joints**

The faying surfaces of friction-grip bolted joints (see SABS 0941) require special attention. Whether left bare or not, all points where moisture could gain access should, in severely corrosive environments, be effectively sealed. The alternative is to protect the faying surfaces, but in this case the effect of the protective coat on the coefficient of friction has to be closely investigated, and the behaviour of the connection under static, dynamic and sustained loading, as applicable, should be considered.

### **A.2.2 Fasteners**

Specific attention is required for the corrosion protection of fasteners. Metallic pre-coatings can be selected which optimize the performance of the subsequent coatings where applicable. Uncoated fasteners to be painted after erection must be degreased and primed before assembly; etch priming may be required on non-ferrous coatings before proceeding with coating. After installation, a heavy coating system is essential to ensure that threads are covered. Stainless steel fasteners or plastic caps over lightly greased fasteners provide alternative means of protection in severely corrosive conditions.

### **A.2.3 Welds**

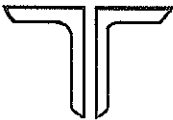
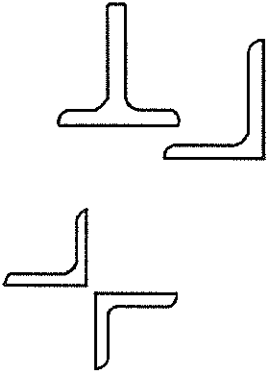

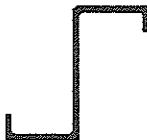
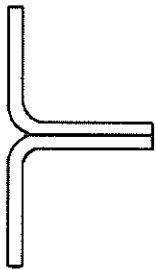
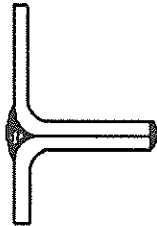
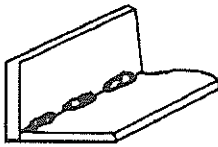
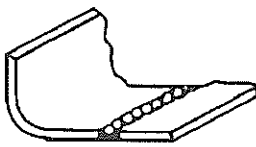
Intermittent or stitch welds inevitably leave crevices which become a potential source of crevice corrosion. Lap joints continuously welded on only one side may also lead to crevice corrosion. If, for structural or economic reasons, stitch welding is selected in severely corrosive conditions, then the resulting crevices should be sealed effectively before, during, or after the application of the protective system.

### **A.2.4 Other Connections**

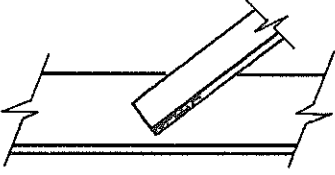
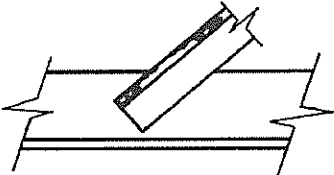
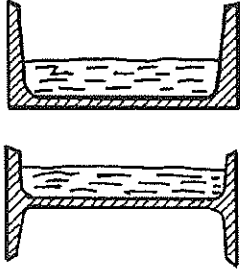
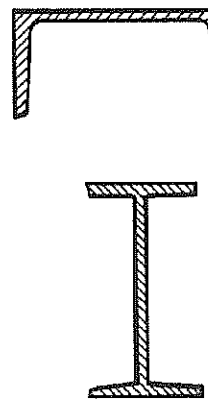
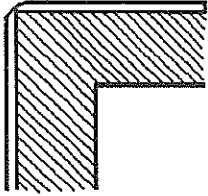
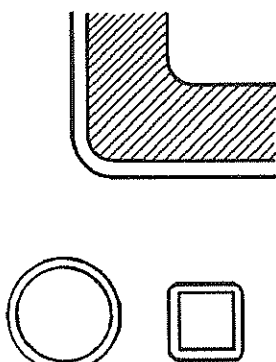
Connections such as lap joints, folded seams and the interfaces between decking plates and supporting beams, being a potential source of crevices, should in severely corrosive environments be sealed effectively to prevent the ingress of moisture and electrolytes.

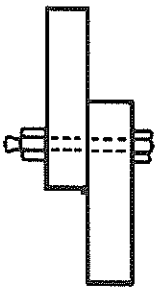

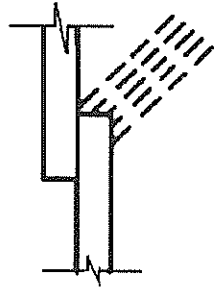
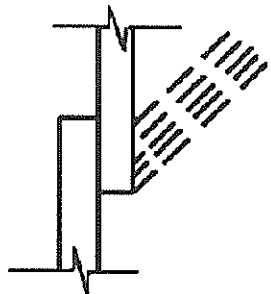
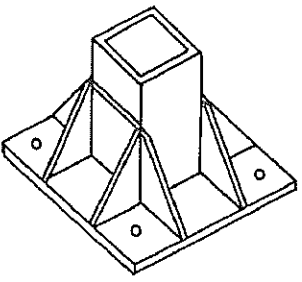
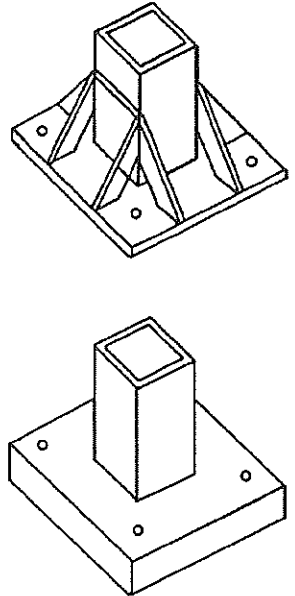
## DESIRABLE STRUCTURAL DESIGN FEATURES


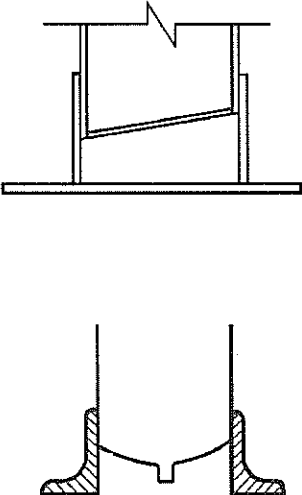
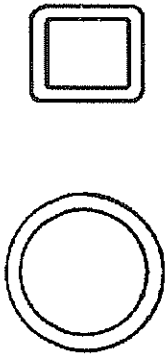

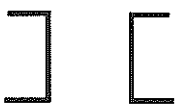
The following diagrams depict solutions to design problems and desirable design features:

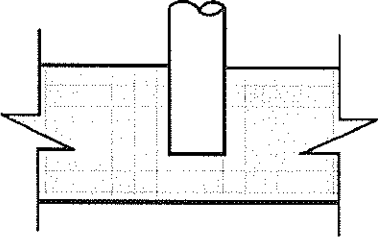
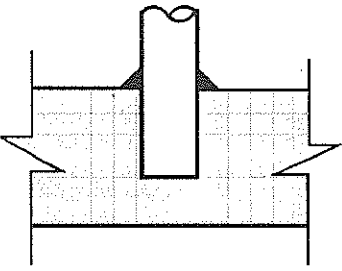
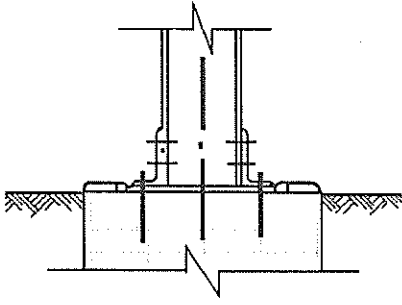
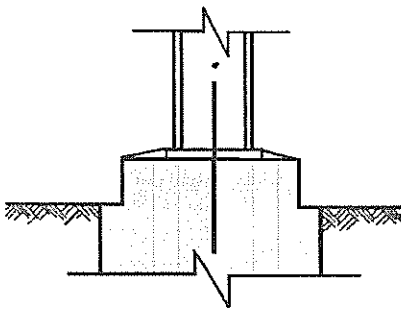
1	2	3
Problem	Typical application	Typical solution
<p>Backs of double angle cannot be painted and maintained</p> 	<p>Double angle truss; bearing member</p>	<p>Design as single angle truss; or use T-section</p> 
<p>Inaccessible corners on inside of lipped channel</p> 	<p>Purlins and girts</p>	<p>Use Z-section</p> 
<p>Potential corrosion due to angles in contact</p> 	<p>Angles in contact</p>	<p>Close crevice by sealing or welding</p> 
<p>Sharp corners and discontinuous welding</p> 	<p>Angles and welds</p>	<p>Round corners and continuous welding</p> 

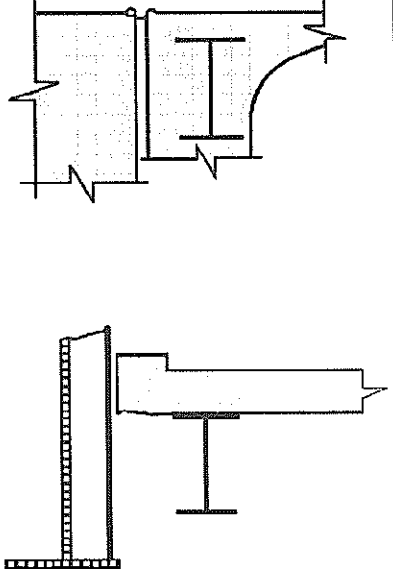
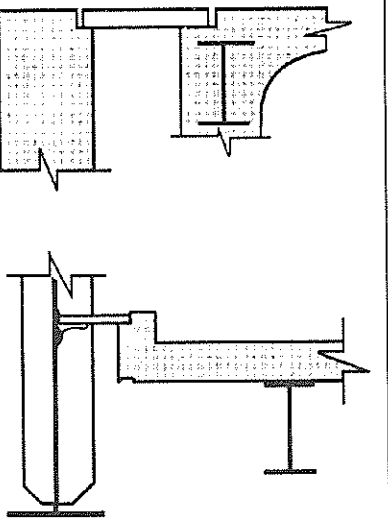


1	2	3
Problem	Typical application	Typical solution
<p data-bbox="172 277 528 331">Lower end of angle could collect dirt and moisture</p> 	<p data-bbox="592 277 804 304">Web member of truss</p>	<p data-bbox="916 277 1034 304">Invert angle</p> 
<p data-bbox="172 815 528 869">Channels or angles could collect dirt and moisture</p> 	<p data-bbox="592 815 836 869">Sheeting girt; tie or strut member</p>	<p data-bbox="916 815 1230 869">Invert section or design to avoid retention of moisture and dirt</p> 
<p data-bbox="172 1384 555 1464">Sharp corners cause concern about possible loss of protection due to paint draw-back</p> 	<p data-bbox="592 1384 794 1438">Structural members generally</p>	<p data-bbox="916 1384 1294 1438">Consider the use of hollow sections or rectangular hollow sections</p> 

1	2	3
Problem	Typical application	Typical solution
<p>Dirt accumulates and moisture penetrates in bolted joints</p> 	<p>Bolted or welded lap joints</p>	<p>Consider using welded or butt-welded joints or sealing with mastic</p> 
<p>Lapped joint creates ledge exposed to weather</p> 	<p>Shell of tank, bin or hopper</p>	<p>Arrange joint so that ledge is not on the weather side</p> 
<p>Gussets create pockets for dirt and moisture</p> 	<p>Column baseplate</p>	<p>Design without gussets or allow drainage</p> 

1	2	3
Problem	Typical application	Typical solution
<p>Plates in loose contact may encourage capillary ingress of moisture</p> 	<p>Service tanks or hopper sitting on steel structure</p>	<p>Locate tank or hoppers on ledge – ensure drainage</p> 
<p>Insides of hollow sections not accessible for painting</p> 	<p>Tubular structures</p>	<p>Prevent entry of air by sealing with suitable welded end-plates. These can often be incorporated into the design, e.g. column base and cap plates</p>
<p>Inadequate access for painting</p> 	<p>Adjacent structures</p>	<p>Provide adequate access for painting</p> 

1	2	3
Problem	Typical application	Typical solution
<p data-bbox="272 282 624 338">Corrosion point where steel member enters concrete</p> 	<p data-bbox="692 282 983 338">Stanchion for handrail or light structure</p>	<p data-bbox="1015 282 1396 360">Paint <math>\pm</math> 50 mm above and below point where steel member enters concrete or provide mastic sealant covering</p> 
<p data-bbox="272 1111 655 1167">Base and bolts at ground level result in water retention and corrosion</p> 	<p data-bbox="692 1111 836 1133">Column bases</p>	<p data-bbox="1015 1111 1390 1211">Column baseplate above ground level. Holding-down bolts not exposed to corrosion. Stalk of column well clear of ground level. Slope for drainage</p> 

1	2	3
Problem	Typical application	Typical solution
<p>Limited access for maintenance painting</p> 	<p>Bridge decking</p>	<p>Accessible for maintenance painting</p> 
<p>Corrosion caused by poor drainage</p>	<p>Bridge decks</p>	<p>Ensure water drains away from structural steel</p> 